







**DICHTUNGSTECHNIK  
SEALING TECHNOLOGY**

**Dichtungen – Formteile  
Seals – Molded Parts**

**DTH-**  
**Dichtungstechnik GmbH**  
Josef-Bautz-Str. 20  
D-63457 Hanau (Germany)  
**Telefon:** +49 (0) 61 81/5 50-81  
**Telefax:** +49 (0) 61 81/5 50-84

**eMail:** [info@dth-dichtungstechnik.de](mailto:info@dth-dichtungstechnik.de)  
**Internet:** [www.dth-dichtungstechnik.de](http://www.dth-dichtungstechnik.de)

**Ihr DTH-Partner:  
Your DTH-Partner:**

D T H- T Y P		MATERIAL	MEDIUM TEMP./DRUCK/ GESCHW INDIGKEIT			
NR .DT H- T YPE- NO.		MATERIAL	MEDIA TEMP./PRESSURE/ SPEED			
	DTH-R0-2000 NB-FA-POM	Stangen- Dachmanschettensatz	NBR NBR-Gewebe POM	Mineralöl	-30°C - +105°C ≤ 400 bar ≤ 0.5 m/sec	Seite
				HFA und HFB	+5°C - +60°C ≤ 400 bar ≤ 0.5 m/sec	63- 65
				HFC	-30°C - +60°C ≤ 400 bar ≤ 0.5 m/sec	
	Rod Packing	NBR Cotton Farbric NBR POM	Mineral oils	-30°C - +105°C ≤ 400 bar ≤ 0.5 m/sec	Page	
			HFA and HFB	+5°C - +60°C ≤ 400 bar ≤ 0.5 m/sec	63- 65	
			HFC	-30°C - +60°C ≤ 400 bar ≤ 0.5 m/sec		
	DTH-PI-6000 NB-FA-POM	Kolben- Dachmanschettensatz	NBR-Gewebe POM	Mineralöl	-30°C - +105°C ≤ 400 bar ≤ 0.5 m/sec	Seite
				HFA und HFB	+5°C - +60°C ≤ 400 bar ≤ 0.5 m/sec	93
				HFC	-30°C - +60°C ≤ 400 bar ≤ 0.5 m/sec	
	Piston Packing	Cotton Farbric NBR POM	Mineral oils	-30°C - +105°C ≤ 400 bar ≤ 0.5 m/sec	Page	
			HFA and HFB	+5°C - +60°C ≤ 400 bar ≤ 0.5 m/sec	93	
			HFC	-30°C - +60°C ≤ 400 bar ≤ 0.5 m/sec		
	DTH-RO-8000 NB-FA-POM	Stangen- Dachmanschettensatz	NBR NBR-Gewebe POM	Mineralöl	-30°C - +105°C ≤ 400 bar ≤ 0.5 m/sec	Seite
				HFA und HFB	+5°C - +60°C ≤ 400 bar ≤ 0.5 m/sec	65
				HFC	-30°C - +60°C ≤ 400 bar ≤ 0.5 m/sec	
	Rod Packing	NBR Cotton Farbric NBR POM	Mineral oils	-30°C - +105°C ≤ 400 bar ≤ 0.5 m/sec	Page	
			HFA and HFB	+5°C - +60°C ≤ 400 bar ≤ 0.5 m/sec	65	
			HFC	-30°C - +60°C ≤ 400 bar ≤ 0.5 m/sec		
	DTH-PI-30000 NBPU	Kolbendichtung	NBR PU	Mineralöl	-30°C - +100°C ≤ 250 bar ≤ 0.5 m/sec	Seite
				HFA und HFB	+5°C - +50°C ≤ 250 bar ≤ 0.5 m/sec	76
				HFC	-30°C - +40°C ≤ 250 bar ≤ 0.5 m/sec	
	Piston Seal	NBR PU	Mineral oils	-30°C - +100°C ≤ 250 bar ≤ 0.5 m/sec	Page	
			HFA and HFB	+5°C - +50°C ≤ 250 bar ≤ 0.5 m/sec	76	
			HFC	-30°C - +40°C ≤ 250 bar ≤ 0.5 m/sec		



DTH-PI-32000  
NBFP

Kompakt-  
kolbendichtung

NBR  
NBR-Gewebe  
POM

Mineralöl	-30°C - +105°C ≤ 400 bar ≤ 0.5 m/sec
HFA und HFB	+5°C - +60°C ≤ 400 bar ≤ 0.5 m/sec
HFC	-30°C - +60°C ≤ 400 bar ≤ 0.5 m/sec

Seite  
89

Compact  
Piston Seal

NBR  
Cotton Farbric NBR  
POM

Mineral oils	-30°C - +105°C ≤ 400 bar ≤ 0.5 m/sec
HFA and HFB	+5°C - +60°C ≤ 400 bar ≤ 0.5 m/sec
HFC	-30°C - +60°C ≤ 400 bar ≤ 0.5 m/sec

Page  
89



DTH-PI-34000  
PTFE-NB

Kolbendichtung

NBR  
PTFE

Mineralöl	-30°C - +105°C ≤ 400 bar ≤ 5.0 m/sec
HFA und HFB	+5°C - +60°C ≤ 400 bar ≤ 5.0 m/sec
HFC	-30°C - +60°C ≤ 400 bar ≤ 5.0 m/sec

Seite  
79-80

Piston Seal

NBR  
PTFE

Mineral oils	-30°C - +105°C ≤ 400 bar ≤ 5.0 m/sec
HFA and HFB	+5°C - +60°C ≤ 400 bar ≤ 5.0 m/sec
HFC	-30°C - +60°C ≤ 400 bar ≤ 5.0 m/sec

Page  
79-80



DTH-PI-36000  
NB-TPE-POM

Kompakt-  
kolbendichtung

NBR  
TPE  
POM

Mineralöl	-30°C - +105°C ≤ 400 bar ≤ 0.5 m/sec
HFA und HFB	+5°C - +60°C ≤ 400 bar ≤ 0.5 m/sec
HFC	-30°C - +60°C ≤ 400 bar ≤ 0.5 m/sec

Seite  
86

Compact  
Piston Seal

NBR  
TPE  
POM

Mineral oils	-30°C - +105°C ≤ 400 bar ≤ 0.5 m/sec
HFA and HFB	+5°C - +60°C ≤ 400 bar ≤ 0.5 m/sec
HFC	-30°C - +60°C ≤ 400 bar ≤ 0.5 m/sec

Page  
86



DTH-PI-1036000  
NB-TPP

Kompakt-  
kolbendichtung

NBR  
POM

Mineralöl	-30°C - +105°C ≤ 400 bar ≤ 0.5 m/sec
HFA und HFB	+5°C - +60°C ≤ 400 bar ≤ 0.5 m/sec
HFC	-30°C - +60°C ≤ 400 bar ≤ 0.5 m/sec

Seite  
88

Compact  
Piston Seal

NBR  
POM

Mineral oils	-30°C - +105°C ≤ 400 bar ≤ 0.5 m/sec
HFA and HFB	+5°C - +60°C ≤ 400 bar ≤ 0.5 m/sec
HFC	-30°C - +60°C ≤ 400 bar ≤ 0.5 m/sec

Page  
88



DTH-PI-38000  
PTFE-NB-POM

Schwerhydraulik  
Kolbendichtung

NBR  
PTFE  
POM

Mineralöl	-30°C - +105°C ≤ 400 bar ≤ 1.5 m/sec	Seite
HFA und HFB	+5°C - +60°C ≤ 400 bar ≤ 1.5 m/sec	84
HFC	-30°C - +60°C ≤ 400 bar ≤ 1.5 m/sec	

Heavy Duty  
Piston Seal

NBR  
PTFE  
POM

Mineral oils	-30°C - +105°C ≤ 400 bar ≤ 1.5 m/sec	Page
HFA and HFB	+5°C - +60°C ≤ 400 bar ≤ 1.5 m/sec	84
HFC	-30°C - +60°C ≤ 400 bar ≤ 1.5 m/sec	



DTH-PI-40000  
NB-POM

Kompakt-  
kolbendichtung

NBR  
POM

Mineralöl	-30°C - +105°C ≤ 150 bar ≤ 0.5 m/sec	Seite
HFA und HFB	+5°C - +60°C ≤ 150 bar ≤ 0.5 m/sec	92
HFC	-30°C - +60°C ≤ 150 bar ≤ 0.5 m/sec	

Compact  
Piston Seal

NBR  
POM

Mineral oils	-30°C - +105°C ≤ 150 bar ≤ 0.5 m/sec	Page
HFA and HFB	+5°C - +60°C ≤ 150 bar ≤ 0.5 m/sec	92
HFC	-30°C - +60°C ≤ 150 bar ≤ 0.5 m/sec	



DTH-PIRO-  
42000  
NB

Kolben und  
Stangendichtung

NBR

Mineralöl	-30°C - +105°C ≤ 150 bar ≤ 0.5 m/sec	Seite
HFA und HFB	+5°C - +60°C ≤ 150 bar ≤ 0.5 m/sec	21-27
HFC	-30°C - +60°C ≤ 150 bar ≤ 0.5 m/sec	

Piston Rod Seal

NBR

Mineral oils	-30°C - +105°C ≤ 150 bar ≤ 0.5 m/sec	Page
HFA and HFB	+5°C - +60°C ≤ 150 bar ≤ 0.5 m/sec	21-27
HFC	-30°C - +60°C ≤ 150 bar ≤ 0.5 m/sec	



DTH-PIRO-  
42000  
PU

Kolben und  
Stangendichtung

PU

Mineralöl	-30°C - +100°C ≤ 400 bar ≤ 0.5 m/sec	Seite
HFA und HFB	+5°C - +50°C ≤ 400 bar ≤ 0.5 m/sec	28-34
HFC	-30°C - +40°C ≤ 400 bar ≤ 0.5 m/sec	

Piston Rod Seal

PU

Mineral oils	-30°C - +100°C ≤ 400 bar ≤ 0.5 m/sec	Page
HFA and HFB	+5°C - +50°C ≤ 400 bar ≤ 0.5 m/sec	28-34
HFC	-30°C - +40°C ≤ 400 bar ≤ 0.5 m/sec	





DTH-RO-44000 Stangendichtung NBR  
NB

Mineralöl	-30°C - +105°C ≤ 150 bar ≤ 0.5 m/sec	Seite
HFA und HFB	+5°C - +60°C ≤ 150 bar ≤ 0.5 m/sec	37-39
HFC	-30°C - +60°C ≤ 150 bar ≤ 0.5 m/sec	

Rod Seal NBR

Mineral oils	-30°C - +105°C ≤ 150 bar ≤ 0.5 m/sec	Page
HFA and HFB	+5°C - +60°C ≤ 150 bar ≤ 0.5 m/sec	37-39
HFC	-30°C - +60°C ≤ 150 bar ≤ 0.5 m/sec	



DTH-RO-44000 Stangendichtung PU  
PU

Mineralöl	-30°C - +100°C ≤ 400 bar ≤ 0.5 m/sec	Seite
HFA und HFB	+5°C - +50°C ≤ 400 bar ≤ 0.5 m/sec	40-42
HFC	-30°C - +40°C ≤ 400 bar ≤ 0.5 m/sec	

Rod Seal PU

Mineral oils	-30°C - +100°C ≤ 400 bar ≤ 0.5 m/sec	Page
HFA and HFB	+5°C - +50°C ≤ 400 bar ≤ 0.5 m/sec	40-42
HFC	-30°C - +40°C ≤ 400 bar ≤ 0.5 m/sec	



DTH-PI-46000 Kolbendichtung NBR  
NB

Mineralöl	-30°C - +105°C ≤ 150 bar ≤ 0.5 m/sec	Seite
HFA und HFB	+5°C - +60°C ≤ 150 bar ≤ 0.5 m/sec	68-69
HFC	-30°C - +60°C ≤ 150 bar ≤ 0.5 m/sec	

Piston Seal NBR

Mineral oils	-30°C - +105°C ≤ 150 bar ≤ 0.5 m/sec	Page
HFA and HFB	+5°C - +60°C ≤ 150 bar ≤ 0.5 m/sec	68-69
HFC	-30°C - +60°C ≤ 150 bar ≤ 0.5 m/sec	



DTH-PI-46000 Kolbendichtung PU  
PU

Mineralöl	-30°C - +100°C ≤ 400 bar ≤ 0.5 m/sec	Seite
HFA und HFB	+5°C - +50°C ≤ 400 bar ≤ 0.5 m/sec	70-71
HFC	-30°C - +40°C ≤ 400 bar ≤ 0.5 m/sec	

Piston Seal PU

Mineral oils	-30°C - +100°C ≤ 400 bar ≤ 0.5 m/sec	Page
HFA and HFB	+5°C - +50°C ≤ 400 bar ≤ 0.5 m/sec	70-71
HFC	-30°C - +40°C ≤ 400 bar ≤ 0.5 m/sec	



DTH-PI-50000  
NB-MET

Pneumatik  
Kolbendichtung

NBR  
Stahl

Druckluft  
sowohl ge-  
wartet als  
auch trocken  
und ölfrei

-30°C - +105°C  
≤ 16 bar ≤ 1.0 m/sec

Seite

98

Pneumatic  
Piston Seal

NBR  
Steel

Prepared,  
dried and  
de-oiled  
compressed air

-30°C - +105°C  
≤ 16 bar ≤ 1.0 m/sec

Page  
98



DTH-PI-52000  
NB-MET

Hydraulik  
Kolbendichtung

NBR  
Stahl  
Rostfreie Stahlfeder

Mineralöl

-30°C - +105°C  
≤ 0.5 m/sec

Seite

HFA und  
HFB

+5°C - +60°C  
≤ 0.5 m/sec

96-97

HFC

-30°C - +60°C  
≤ 0.5 m/sec

Druckluft

-30°C - +105°C  
≤ 0.5 m/sec

Hydraulic Piston Seal

NBR  
Steel  
Stainless Steel  
Spring

Mineral  
oils

-30°C - +105°C  
≤ 0.5 m/sec

Page

HFA and  
HFB

+5°C - +60°C  
≤ 0.5 m/sec

96-97

HFC

-30°C - +60°C  
≤ 0.5 m/sec

Compressed  
Air

-30°C - +105°C  
≤ 0.5 m/sec



DTH-RO-58000  
PU

Pufferdichtung

PU  
POM

Mineralöl

-30°C - +100°C  
≤ 400 bar ≤ 0.5 m/sec

Seite

HFA und  
HFB

+5°C - +50°C  
≤ 400 bar ≤ 0.5 m/sec

67

HFC

-30°C - +40°C  
≤ 400 bar ≤ 0.5 m/sec

Buffer Seal

PU  
POM

Mineral  
oils

-30°C - +100°C  
≤ 400 bar ≤ 0.5 m/sec

Page

HFA and  
HFB

+5°C - +50°C  
≤ 400 bar ≤ 0.5 m/sec

67

HFC

-30°C - +40°C  
≤ 400 bar ≤ 0.5 m/sec



DTH-RO-60000  
NB-MET

Pneumatik Kombi  
Dichtung

NBR  
Stahl

Druckluft  
sowohl ge-  
wartet als  
auch trocken  
und ölfrei

-30°C - +105°C  
≤ 16 bar ≤ 1.0 m/sec

Seite

100

Pneumatic Combi  
Seal

NBR  
Steel

Prepared,  
dried and  
de-oiled  
compressed air

-30°C - +105°C  
≤ 16 bar ≤ 1.0 m/sec

Page  
100



DTH-RO-62000  
PU

Schwerhydraulik  
Stangendichtung

NBR  
PU  
POM

Mineralöl	-30°C - +100°C ≤ 630 bar ≤ 0.5 m/sec	Seite
HFA und HFB	+5°C - +50°C ≤ 630 bar ≤ 0.5 m/sec	53
HFC	-30°C - +40°C ≤ 630 bar ≤ 0.5 m/sec	

Heavy Duty  
Rod Seal

NBR  
PU  
POM

Mineral oils	-30°C - +100°C ≤ 630 bar ≤ 0.5 m/sec	Page
HFA and HFB	+5°C - +50°C ≤ 630 bar ≤ 0.5 m/sec	53
HFC	-30°C - +40°C ≤ 630 bar ≤ 0.5 m/sec	



DTH-RO-64000  
PU

Stangendichtung

PU  
POM

Mineralöl	-30°C - +100°C ≤ 400 bar ≤ 0.5 m/sec	Seite
HFA und HFB	+5°C - +50°C ≤ 400 bar ≤ 0.5 m/sec	49
HFC	-30°C - +40°C ≤ 400 bar ≤ 0.5 m/sec	

Rod Seal

PU  
POM

Mineral oils	-30°C - +100°C ≤ 400 bar ≤ 0.5 m/sec	Page
HFA and HFB	+5°C - +50°C ≤ 400 bar ≤ 0.5 m/sec	49
HFC	-30°C - +40°C ≤ 400 bar ≤ 0.5 m/sec	



DTH-RO-66000  
PU

Stangendichtung

PU

Mineralöl	-30°C - +100°C ≤ 400 bar ≤ 0.5 m/sec	Seite
HFA und HFB	+5°C - +50°C ≤ 400 bar ≤ 0.5 m/sec	43-45
HFC	-30°C - +40°C ≤ 400 bar ≤ 0.5 m/sec	

Rod Seal

PU

Mineral oils	-30°C - +100°C ≤ 400 bar ≤ 0.5 m/sec	Page
HFA and HFB	+5°C - +50°C ≤ 400 bar ≤ 0.5 m/sec	43-45
HFC	-30°C - +40°C ≤ 400 bar ≤ 0.5 m/sec	



DTH-RO-68000  
NB-FA-TP-PO

Stangendichtungssatz

NBR  
NBR Gewebe  
TPE  
POM

Mineralöl	-30°C - +105°C ≤ 700 bar ≤ 0.5 m/sec	Seite
HFA und HFB	+5°C - +60°C ≤ 700 bar ≤ 0.5 m/sec	60
HFC	-30°C - +60°C ≤ 700 bar ≤ 0.5 m/sec	

Rod Seal

NBR  
Cotton Fabric NBR  
TPE  
POM

Mineral oils	-30°C - +105°C ≤ 700 bar ≤ 0.5 m/sec	Page
HFA and HFB	+5°C - +60°C ≤ 700 bar ≤ 0.5 m/sec	60
HFC	-30°C - +60°C ≤ 700 bar ≤ 0.5 m/sec	



DTH-RO-70000 Stangendichtung  
PTFE-NB

NBR  
PTFE

Mineralöl -30°C - +105°C  
≤ 400 bar ≤ 5.0 m/sec

Seite

HFA und HFB +5°C - +60°C  
≤ 400 bar ≤ 5.0 m/sec

56-57

HFC -30°C - +60°C  
≤ 400 bar ≤ 5.0 m/sec

Rod Seal

NBR  
PTFE

Mineral oils -30°C - +105°C  
≤ 400 bar ≤ 5.0 m/sec

Page

HFA and HFB +5°C - +60°C  
≤ 400 bar ≤ 5.0 m/sec

56-57

HFC -30°C - +60°C  
≤ 400 bar ≤ 5.0 m/sec



DTH-PIRO-72000  
NB-FA

Stangen -  
Kolbendichtung

NBR  
NBR Gewebe

Mineralöl -30°C - +105°C  
≤ 250 bar ≤ 0.5 m/sec

Seite

HFA und HFB +5°C - +60°C  
≤ 250 bar ≤ 0.5 m/sec

73-74

HFC -30°C - +60°C  
≤ 250 bar ≤ 0.5 m/sec

Piston Rod Seal

NBR  
Cotton Fabric NBR

Mineral oils -30°C - +105°C  
≤ 250 bar ≤ 0.5 m/sec

Page

HFA and HFB +5°C - +60°C  
≤ 250 bar ≤ 0.5 m/sec

73-74

HFC -30°C - +60°C  
≤ 250 bar ≤ 0.5 m/sec



DTH-RO-74000 Stangendichtung  
NB-FA-POM

NBR  
NBR Gewebe  
POM

Mineralöl -30°C - +105°C  
≤ 400 bar ≤ 0.5 m/sec

Seite

HFA und HFB +5°C - +60°C  
≤ 400 bar ≤ 0.5 m/sec

50-52

HFC -30°C - +60°C  
≤ 400 bar ≤ 0.5 m/sec

Rod Seal

NBR  
Cotton Fabric NBR  
POM

Mineral oils -30°C - +105°C  
≤ 400 bar ≤ 0.5 m/sec

Page

HFA and HFB +5°C - +60°C  
≤ 400 bar ≤ 0.5 m/sec

50-52

HFC -30°C - +60°C  
≤ 400 bar ≤ 0.5 m/sec



DTH-RO-76000 Stangendichtung  
PU

PU

Mineralöl -30°C - +100°C  
≤ 400 bar ≤ 0.5 m/sec

Seite

HFA und HFB +5°C - +50°C  
≤ 400 bar ≤ 0.5 m/sec

47-48

HFC -30°C - +40°C  
≤ 400 bar ≤ 0.5 m/sec

Rod Seal

PU

Mineral oils -30°C - +100°C  
≤ 400 bar ≤ 0.5 m/sec

Page

HFA and HFB +5°C - +50°C  
≤ 400 bar ≤ 0.5 m/sec

47-48

HFC -30°C - +40°C  
≤ 400 bar ≤ 0.5 m/sec



	DTH-RO-78000 NB-FA	Stangendichtung	NBR NBR Gewebe	Mineralöl	-30°C - +105°C ≤ 250 bar ≤ 0.5 m/sec	Seite
				HFA und HFB	+5°C - +60°C ≤ 250 bar ≤ 0.5 m/sec	58
				HFC	-30°C - +60°C ≤ 250 bar ≤ 0.5 m/sec	

		Rod Seal	NBR Cotton Fabric NBR	Mineral oils	-30°C - +105°C ≤ 250 bar ≤ 0.5 m/sec	Page
				HFA and HFB	+5°C - +60°C ≤ 250 bar ≤ 0.5 m/sec	58
				HFC	-30°C - +60°C ≤ 250 bar ≤ 0.5 m/sec	

	DTH-PI-80000 PU	Kolbendichtung	PU POM	Mineralöl	-30°C - +100°C ≤ 400 bar ≤ 0.5 m/sec	Seite
				HFA und HFB	+5°C - +50°C ≤ 400 bar ≤ 0.5 m/sec	72
				HFC	-30°C - +40°C ≤ 400 bar ≤ 0.5 m/sec	

		Piston Seal	PU POM	Mineral oils	-30°C - +100°C ≤ 400 bar ≤ 0.5 m/sec	Page
				HFA and HFB	+5°C - +50°C ≤ 400 bar ≤ 0.5 m/sec	72
				HFC	-30°C - +40°C ≤ 400 bar ≤ 0.5 m/sec	

	DTH-PI-82000 PTFE-NB	Kolbendichtung	NBR PTFE	Mineralöl	-30°C - +105°C ≤ 400 bar ≤ 5.0 m/sec	Seite
				HFA und HFB	+5°C - +60°C ≤ 400 bar ≤ 5.0 m/sec	81
				HFC	-30°C - +60°C ≤ 400 bar ≤ 5.0 m/sec	

		Piston Seal	NBR PTFE	Mineral oils	-30°C - +105°C ≤ 400 bar ≤ 5.0 m/sec	Page
				HFA and HFB	+5°C - +60°C ≤ 400 bar ≤ 5.0 m/sec	81
				HFC	-30°C - +60°C ≤ 400 bar ≤ 5.0 m/sec	

	DTH-PI-84000 NB-TP-POM	Kompakt Kolbendichtung	NBR TPE POM	Mineralöl	-30°C - +105°C ≤ 700 bar ≤ 0.5 m/sec	Seite
				HFA und HFB	+5°C - +60°C ≤ 700 bar ≤ 0.5 m/sec	90
				HFC	-30°C - +60°C ≤ 700 bar ≤ 0.5 m/sec	

		Compact Piston Seal	NBR TPE POM	Mineral oils	-30°C - +105°C ≤ 700 bar ≤ 0.5 m/sec	Page
				HFA and HFB	+5°C - +60°C ≤ 700 bar ≤ 0.5 m/sec	90
				HFC	-30°C - +60°C ≤ 700 bar ≤ 0.5 m/sec	



DTH-PI-86000  
NB-FA-POM

Kolbendichtung

NBR  
NBR Gewebe  
POM

Mineralöl	-30°C - +105°C ≤ 500 bar ≤ 0.5 m/sec
HFA und HFB	+5°C - +60°C ≤ 500 bar ≤ 0.5 m/sec
HFC	-30°C - +60°C ≤ 500 bar ≤ 0.5 m/sec

Seite

85

Piston Seal

NBR  
Cotton Fabric NBR  
POM

Mineral oils	-30°C - +105°C ≤ 500 bar ≤ 0.5 m/sec
HFA and HFB	+5°C - +60°C ≤ 500 bar ≤ 0.5 m/sec
HFC	-30°C - +60°C ≤ 500 bar ≤ 0.5 m/sec

Page

85



DTH-PI-92000  
PU-POM-NB

Kompakt  
Kolbendichtung

PU  
POM  
NB

Mineralöl	-30°C - +100°C ≤ 400 bar ≤ 0.5 m/sec
HFA und HFB	+5°C - +50°C ≤ 400 bar ≤ 0.5 m/sec
HFC	-30°C - +40°C ≤ 400 bar ≤ 0.5 m/sec

Seite

90

Compact  
Piston Seal

PU  
POM  
NB

Mineral oils	-30°C - +100°C ≤ 400 bar ≤ 0.5 m/sec
HFA and HFB	+5°C - +50°C ≤ 400 bar ≤ 0.5 m/sec
HFC	-30°C - +40°C ≤ 400 bar ≤ 0.5 m/sec

Page

90



DTH-PI-98000  
PU-NB

Kolbendichtung

PU  
NB

Mineralöl	-30°C - +100°C ≤ 400 bar ≤ 0.5 m/sec
HFA und HFB	+5°C - +50°C ≤ 400 bar ≤ 0.5 m/sec
HFC	-30°C - +40°C ≤ 400 bar ≤ 0.5 m/sec

Seite

77

Piston Seal

PU  
NB

Mineral oils	-30°C - +100°C ≤ 400 bar ≤ 0.5 m/sec
HFA and HFB	+5°C - +50°C ≤ 400 bar ≤ 0.5 m/sec
HFC	-30°C - +40°C ≤ 400 bar ≤ 0.5 m/sec

Page

77



DTH-PI-100000  
NB

Pneumatik  
Kolbendichtung

NBR

Druckluft sowohl ge- wartet als auch trocken und ölfrei	-30°C - +105°C ≤ 12 bar ≤ 1.0 m/sec
---	--

Seite





103

Pneumatic  
Piston Seal

NBR

Prepared, dried and de-oiled compressed air	-30°C - +105°C ≤ 12 bar ≤ 1.0 m/sec
--	--

Page  
103

	DTH-PI-100000 PU	Pneumatik Kolbendichtung	PU	Druckluft sowohl ge- wartet als auch trocken und ölfrei	-30°C - +80°C ≤ 16 bar ≤ 1.0 m/sec	Seite
		Pneumatic Piston Seal	PU	Prepared, dried and de-oiled compressed air	-30°C - +80°C ≤ 16 bar ≤ 1.0 m/sec	103 Page 103
<hr/>						
	DTH-RO-102000 PU	Pneumatik Kombi Dichtung	PU	Druckluft sowohl ge- wartet als auch trocken und ölfrei	-30°C - +80°C ≤ 16 bar ≤ 1.0 m/sec	Seite
		Pneumatic Rod Seal	PU	Prepared, dried and de-oiled compressed air	-30°C - +80°C ≤ 16 bar ≤ 1.0 m/sec	102 Page 102
<hr/>						
	DTH-00-104000 NB	Pneumatik Kombi Dichtung	NBR	Druckluft sowohl ge- wartet als auch trocken und ölfrei	-30°C - +105°C ≤ 12 bar ≤ 1.0 m/sec	Seite
		Pneumatic Combi Seal	NBR	Prepared, dried and de-oiled compressed air	-30°C - +105°C ≤ 12 bar ≤ 1.0 m/sec	101 Page 101
<hr/>						
	DTH-00-104000 PU	Pneumatik Kombi Dichtung	PU	Druckluft sowohl ge- wartet als auch trocken und ölfrei	-30°C - +80°C ≤ 16 bar ≤ 1.0 m/sec	Seite
		Pneumatic Combi Seal	PU	Prepared, dried and de-oiled compressed air	-30°C - +80°C ≤ 16 bar ≤ 1.0 m/sec	101 Page 101
<hr/>						
	DTH-R0-106000 NB	Pneumatik Dämpfungsring	NBR	Druckluft sowohl ge- wartet als auch trocken und ölfrei	-30°C - +105°C ≤ 12 bar ≤ 1.0 m/sec	Seite
		Pneumatic Cushioning Seal	NBR	Prepared, dried and de-oiled compressed air	-30°C - +105°C ≤ 12 bar ≤ 1.0 m/sec	107 Page 107
<hr/>						



DTH-RO-106000 Pneumatik  
PU Dämpfungsring

PU

Druckluft  
sowohl ge-  
wartet als  
auch trocken  
und ölfrei

-30°C - +80°C  
≤ 16 bar ≤ 1.0 m/sec

Seite

107

Pneumatic  
Cushioning Seal

PU

Prepared,  
dried and  
de-oiled  
compressed air

-30°C - +80°C  
≤ 16 bar ≤ 1.0 m/sec

Page  
107



DTH-PI-108000 Pneumatik  
NB Kolbendichtung

NBR

Druckluft  
sowohl ge-  
wartet als  
auch trocken  
und ölfrei

-30°C - +105°C  
≤ 12 bar ≤ 1.0 m/sec

Seite

105

Pneumatic  
Piston Seal

NBR

Prepared,  
dried and  
de-oiled  
compressed air

-30°C - +105°C  
≤ 12 bar ≤ 1.0 m/sec

Page  
105



DTH-PI-110000 Pneumatik  
NB-ALU Kolbendichtung

NBR  
ALUMINIUM

Druckluft  
sowohl ge-  
wartet als  
auch trocken  
und ölfrei

-30°C - +105°C  
≤ 12 bar ≤ 1.0 m/sec

Seite

99

Pneumatic  
Piston Seal

NBR  
ALUMINIUM

Prepared,  
dried and  
de-oiled  
compressed air

-30°C - +105°C  
≤ 12 bar ≤ 1.0 m/sec

Page  
99



DTH-00-112000 Pneumatik  
NB-TPE Dicht-Abstreif-Satz

NBR  
TPE

Druckluft  
sowohl ge-  
wartet als  
auch trocken  
und ölfrei

-30°C - +105°C  
≤ 16 bar ≤ 1.0 m/sec

Seite

102

Pneumatic  
Rod Seal

NBR  
TPE

Prepared,  
dried and  
de-oiled  
compressed air

-30°C - +105°C  
≤ 16 bar ≤ 1.0 m/sec

Page  
102



DTH-PI-114000 Pneumatik  
NB-ALU Komplettkolben

NBR  
ALUMINIUM

Druckluft  
sowohl ge-  
wartet als  
auch trocken  
und ölfrei

-30°C - +105°C  
≤ 12 bar ≤ 1.0 m/sec

Seite

99

Pneumatic  
Piston Seal

NBR  
ALUMINIUM

Prepared,  
dried and  
de-oiled  
compressed air

-30°C - +105°C  
≤ 12 bar ≤ 1.0 m/sec

Page  
99





DTH-PI-116000  
PU-POM-  
ALU-MAG

Pneumatik  
Kolbendichtsatz

PU  
POM  
ALUMINIUM  
MAGNET  
NBR

Druckluft  
sowohl ge-  
wartet als  
auch trocken  
und ölfrei

-30°C - +80°C  
≤ 16 bar ≤ 1.0 m/sec

Seite

100

Pneumatic  
Piston Seal

PU  
POM  
ALUMINIUM  
MAGNET  
NBR

Prepared,  
dried and  
de-oiled  
compressed air

-30°C - +80°C  
≤ 16 bar ≤ 1.0 m/sec

Page  
100



DTH-PI-118000  
NB

Pneumatik  
Kolbendichtung

NBR

Druckluft  
sowohl ge-  
wartet als  
auch trocken  
und ölfrei

-30°C - +105°C  
≤ 12 bar ≤ 1.0 m/sec

Seite

104

Pneumatic  
Piston Seal

NBR

Prepared,  
dried and  
de-oiled  
compressed air

-30°C - +105°C  
≤ 12 bar ≤ 1.0 m/sec

Page  
104



DTH-PI-118000  
PU

Pneumatik  
Kolbendichtung

PU

Druckluft  
sowohl ge-  
wartet als  
auch trocken  
und ölfrei

-30°C - +80°C  
≤ 16 bar ≤ 1.0 m/sec

Seite

104

Pneumatic  
Piston Seal

PU

Prepared,  
dried and  
de-oiled  
compressed air

-30°C - +80°C  
≤ 16 bar ≤ 1.0 m/sec

Page  
104



DTH-PI-124000  
NB

Pneumatik  
Kolbendichtung

NBR

Druckluft  
sowohl ge-  
wartet als  
auch trocken  
und ölfrei

-30°C - +105°C  
≤ 12 bar ≤ 1.0 m/sec

Seite

105

Pneumatic  
Piston Seal

NBR

Prepared,  
dried and  
de-oiled  
compressed air

-30°C - +105°C  
≤ 12 bar ≤ 1.0 m/sec

Page  
105

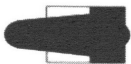

DTH-PI-126000  
NB

Pneumatik  
Kolbendichtung

NBR

Druckluft  
sowohl ge-  
wartet als  
auch trocken  
und ölfrei

-30°C - +105°C  
≤ 12 bar ≤ 1.0 m/sec

Seite

106

Pneumatic  
Piston Seal

NBR

Prepared,  
dried and  
de-oiled  
compressed air

-30°C - +105°C  
≤ 12 bar ≤ 1.0 m/sec

Page  
106

DTH-RO-136000 POM-GLASS	Stangenführungs- ring	POM (gefüllt)	Mineralöl	-30°C - +125°C ≤ 40 N/mm <sup>2</sup> ≤ 1.0 m/sec	Seite
			HFA und HFB	+5°C - +50°C ≤ 40 N/mm <sup>2</sup> ≤ 1.0 m/sec	114-
			HFC	-30°C - +40°C ≤ 40 N/mm <sup>2</sup> ≤ 1.0 m/sec	116

Rod Guide Ring	POM special filled	Mineral oils	-30°C - +125°C ≤ 40 N/mm <sup>2</sup> ≤ 1.0 m/sec	Page
		HFA and HFB	+5°C - +50°C ≤ 40 N/mm <sup>2</sup> ≤ 1.0 m/sec	114-
		HFC	-30°C - +40°C ≤ 40 N/mm <sup>2</sup> ≤ 1.0 m/sec	116

DTH-PI-138000 POM-GLASS	Kolbenführungs- ring	POM (gefüllt)	Mineralöl	-30°C - +125°C ≤ 40 N/mm <sup>2</sup> ≤ 1.0 m/sec	Seite
			HFA und HFB	+5°C - +50°C ≤ 40 N/mm <sup>2</sup> ≤ 1.0 m/sec	117-
			HFC	-30°C - +40°C ≤ 40 N/mm <sup>2</sup> ≤ 1.0 m/sec	119

Piston Guide Ring	POM special filled	Mineral oils	-30°C - +125°C ≤ 40 N/mm <sup>2</sup> ≤ 1.0 m/sec	Page
		HFA and HFB	+5°C - +50°C ≤ 40 N/mm <sup>2</sup> ≤ 1.0 m/sec	117-
		HFC	-30°C - +40°C ≤ 40 N/mm <sup>2</sup> ≤ 1.0 m/sec	119

DTH-ROPI-146000 POLY-PTFE	Kolben-Stangen- Führungsring	Polyesterharz	Mineralöl	-40°C - +120°C ≤ 100 N/mm <sup>2</sup> ≤ 1.0 m/sec	Seite
			HFA und HFB	+5°C - +60°C ≤ 100 N/mm <sup>2</sup> ≤ 1.0 m/sec	110-
			HFC	-40°C - +40°C ≤ 100 N/mm <sup>2</sup> ≤ 1.0 m/sec	111

Piston-Rod Guide Ring	Polyester Resin	Mineral oils	-40°C - +120°C ≤ 100 N/mm <sup>2</sup> ≤ 1.0 m/sec	Page
		HFA and HFB	+5°C - +60°C ≤ 100 N/mm <sup>2</sup> ≤ 1.0 m/sec	110-
		HFC	-40°C - +40°C ≤ 100 N/mm <sup>2</sup> ≤ 1.0 m/sec	111

DTH-RO-148000 POM-GLASS	Stangenführungs- ring	POM (Spezial)	Mineralöl	-30°C - +125°C ≤ 40 N/mm <sup>2</sup> ≤ 1.0 m/sec	Seite
			HFA und HFB	+5°C - +50°C ≤ 40 N/mm <sup>2</sup> ≤ 1.0 m/sec	116
			HFC	-30°C - +40°C ≤ 40 N/mm <sup>2</sup> ≤ 1.0 m/sec	

Rod Guide Ring	POM special filled	Mineral oils	-30°C - +125°C ≤ 40 N/mm <sup>2</sup> ≤ 1.0 m/sec	Page
		HFA and HFB	+5°C - +50°C ≤ 40 N/mm <sup>2</sup> ≤ 1.0 m/sec	116
		HFC	-30°C - +40°C ≤ 40 N/mm <sup>2</sup> ≤ 1.0 m/sec	

  
DTH-ROPI-  
150000 PHEKolben-Stangen-  
Führungsring

Phenolharz

Mineralöl | -50°C - +130°C  
< 40 N/mm<sup>2</sup> ≤ 1.0 m/sec

Seite

HFA und  
HFB | +5°C - +50°C  
< 40 N/mm<sup>2</sup> ≤ 1.0 m/sec

112-

HFC | -30°C - +40°C  
< 40 N/mm<sup>2</sup> ≤ 1.0 m/sec

113

Piston-Rod  
Guide Ring

Phenolic

Mineral  
oils | -50°C - +130°C  
< 40 N/mm<sup>2</sup> ≤ 1.0 m/sec

Page

HFA and  
HFB | +5°C - +50°C  
< 40 N/mm<sup>2</sup> ≤ 1.0 m/sec

112-

HFC | -30°C - +40°C  
< 40 N/mm<sup>2</sup> ≤ 1.0 m/sec

113

  
DTH-PIRO-  
162000 TPE

Stützring

TPE

Mineralöl | -40°C - +120°C  
≤ 500 bar ≤ 1.0 m/sec

Seite

HFA und  
HFB | +5°C - +60°C  
≤ 500 bar ≤ 1.0 m/sec

120-

HFC | -30°C - +60°C  
≤ 500 bar ≤ 1.0 m/sec

121

Back Up Ring

TPE

Mineral  
oils | -40°C - +120°C  
≤ 500 bar ≤ 1.0 m/sec

Page

HFA and  
HFB | +5°C - +60°C  
≤ 500 bar ≤ 1.0 m/sec

120-

HFC | -30°C - +60°C  
≤ 500 bar ≤ 1.0 m/sec

121

  
DTH-FLA-164000  
PU

Flanschdichtung

PU

Mineralöl | -30°C - +100°C  
≤ 600 bar

Seite

HFA und  
HFB | +5°C - +50°C  
≤ 600 bar

122

HFC | -30°C - +40°C  
≤ 600 bar

Flange Seal

PU

Mineral  
oils | -30°C - +100°C  
≤ 600 bar

Page

HFA and  
HFB | +5°C - +50°C  
≤ 600 bar

122

HFC | -30°C - +40°C  
≤ 600 bar  
DTH-COV-  
166000 PU

Cover Dichtung

PU

Mineralöl | -30°C - +100°C  
≤ 600 bar

Seite

HFA und  
HFB | +5°C - +50°C  
≤ 600 bar

66

HFC | -30°C - +40°C  
≤ 600 bar

Cover Seal

PU

Mineral  
oils | -30°C - +100°C  
≤ 600 bar

Page

HFA and  
HFB | +5°C - +50°C  
≤ 600 bar

66

HFC | -30°C - +40°C  
≤ 600 bar

	DTH-COV-168000 PU	Cover Dichtung	PU	Mineralöl	-30°C - +100°C ≤ 600 bar	Seite
				HFA und HFB	+5°C - +50°C ≤ 600 bar	94-95
				HFC	-30°C - +40°C ≤ 600 bar	
		Cover Seal	PU	Mineral oils	-30°C - +100°C ≤ 600 bar	Page
				HFA and HFB	+5°C - +50°C ≤ 600 bar	94-95
				HFC	-30°C - +40°C ≤ 600 bar	

	DTH-PIRO-190000 NB	Stangen und Kolben-dichtung	NBR	Mineralöl	-30°C - +105°C ≤ 150 bar ≤ 0.5 m/sec	Seite
				HFA und HFB	+5°C - +60°C ≤ 150 bar ≤ 0.5 m/sec	35-36
				HFC	-30°C - +60°C ≤ 150 bar ≤ 0.5 m/sec	
		Piston Rod Seal	NBR	Mineral oils	-30°C - +105°C ≤ 150 bar ≤ 0.5 m/sec	Page
				HFA and HFB	+5°C - +60°C ≤ 150 bar ≤ 0.5 m/sec	35-36
				HFC	-30°C - +60°C ≤ 150 bar ≤ 0.5 m/sec	

	DTH-RO-192000 NB	Stangendichtung	NBR	Mineralöl	-30°C - +105°C ≤ 150 bar ≤ 0.5 m/sec	Seite
				HFA und HFB	+5°C - +60°C ≤ 150 bar ≤ 0.5 m/sec	46
				HFC	-30°C - +60°C ≤ 150 bar ≤ 0.5 m/sec	
		Rod Seal	NBR	Mineral oils	-30°C - +105°C ≤ 150 bar ≤ 0.5 m/sec	Page
				HFA and HFB	+5°C - +60°C ≤ 150 bar ≤ 0.5 m/sec	46
				HFC	-30°C - +60°C ≤ 150 bar ≤ 0.5 m/sec	

	DTH-RO-300000 NB-FAB	Dachmanschette	NBR Gewebe	Wasser und Emulsion	-30°C - +80°C ≤ 250 bar ≤ 2.0 m/sec	Seite
						62
		Chevron Ring	Cotton Fabric NBR	Water and water-oil mixture	-30°C - +80°C ≤ 250 bar ≤ 2.0 m/sec	Page 62





DTH-RO-302000 Hochdruck-  
NB-FAB-POM- Nuttringsatz  
PTFE

NBR Gewebe  
POM  
PTFE

Mineralöle  
Wasser  
und  
Wasser/Öl

-30°C - +80°C  
≤ 250 bar ≤ 2.0 m/sec

Seite  
59

High Pressure  
Chevron Seal

Cotton Fabric NBR  
POM  
PTFE

Mineral oils,  
water and  
water-oil  
mixture

-30°C - +80°C  
≤ 250 bar ≤ 2.0 m/sec

Page  
59



DTH-RO-304000 Niederdruck-  
NB-FAB-POM Nuttringsatz

NBR Gewebe  
POM

Mineralöle  
Wasser  
und  
Wasser/Öl

-30°C - +80°C  
≤ 80 bar ≤ 2.0 m/sec

Seite  
61

Low Pressure  
Chevron Seal

Cotton Fabric NBR  
POM

Mineral oils,  
water and  
water-oil  
mixture

-30°C - +80°C  
≤ 80 bar ≤ 2.0 m/sec

Page  
61

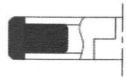

DTH-PI-1002 Kolbendichtung  
PA-NB

PA  
NBR

Mineralöl

-30°C - +105°C  
≤ 500 bar ≤ 1.0 m/sec

HFA und  
HFB

+5°C - +60°C  
≤ 500 bar ≤ 1.0 m/sec

HFC

-30°C - +60°C  
≤ 500 bar ≤ 1.0 m/sec

Seite  
78

Piston Seal

PA  
NBR

Mineral  
oils

-30°C - +105°C  
≤ 500 bar ≤ 1.0 m/sec

HFA and  
HFB

+5°C - +60°C  
≤ 500 bar ≤ 1.0 m/sec

HFC

-30°C - +60°C  
≤ 500 bar ≤ 1.0 m/sec

Page  
78



DTH-PI-1006 Kompakt  
NB-TPE-POM Kolbendichtung

NBR  
TPE  
POM

Mineralöl

-30°C - +105°C  
≤ 250 bar ≤ 0.5 m/sec

HFA und  
HFB

+5°C - +60°C  
≤ 250 bar ≤ 0.5 m/sec

HFC

-30°C - +60°C  
≤ 250 bar ≤ 0.5 m/sec

Seite  
91

Compact Piston Seal

NBR  
TPE  
POM

Mineral  
oils

-30°C - +105°C  
≤ 250 bar ≤ 0.5 m/sec

HFA and  
HFB

+5°C - +60°C  
≤ 250 bar ≤ 0.5 m/sec

HFC

-30°C - +60°C  
≤ 250 bar ≤ 0.5 m/sec

Page  
91



DTH-RO-1402 Federvorgespannte  
PTFE-MET Stangendichtung

PTFE kohlegefüllt  
Feder rostfreier  
Edelstahl

Hydrauliköl  
heiße Luft  
Wasser  
Dampf

-150°C - +250°C  
≤ 350 bar ≤ 15.0 m/sec

Seite  
54

Spring Loaded  
Rod Seal

PTFE  
Stainless Steel Spring

Hydraulic  
oils, hot air,  
water,  
stream

-150°C - +250°C  
≤ 350 bar ≤ 15.0 m/sec

Page  
54



DTH-RO-1402  
PTFE-NB

Rotor Stangen-  
dichtung

NBR  
PTFE

Mineralöl	-30°C - +105°C ≤ 300 bar ≤ 5.0 m/sec
-----------	---

Seite

HFA und HFB	+5°C - +60°C ≤ 300 bar ≤ 5.0 m/sec
----------------	---------------------------------------

55

HFC	-30°C - +60°C ≤ 300 bar ≤ 5.0 m/sec
-----	--

Rod Seal For  
Rotating Applications

NBR  
PTFE

Mineral oils	-30°C - +105°C ≤ 300 bar ≤ 5.0 m/sec
-----------------	---

Page

HFA and HFB	+5°C - +60°C ≤ 300 bar ≤ 5.0 m/sec
----------------	---------------------------------------

55

HFC	-30°C - +60°C ≤ 300 bar ≤ 5.0 m/sec
-----	--



DTH-RO-1408  
PTFE-NB

Stangendichtung

PTFE  
BR  
NBR

Mineralöl	-30°C - +105°C ≤ 400 bar ≤ 5.0 m/sec
-----------	---

Seite

HFA und HFB	+5°C - +60°C ≤ 400 bar ≤ 5.0 m/sec
----------------	---------------------------------------

58

HFC	-30°C - +60°C ≤ 400 bar ≤ 5.0 m/sec
-----	--

Rod Seal

PTFE  
BR  
NBR

Mineral oils	-30°C - +105°C ≤ 400 bar ≤ 5.0 m/sec
-----------------	---

Page

HFA and HFB	+5°C - +60°C ≤ 400 bar ≤ 5.0 m/sec
----------------	---------------------------------------

58

HFC	-30°C - +60°C ≤ 400 bar ≤ 5.0 m/sec
-----	--



DTH-PI-1502  
PTFE-MET

Federvorgespannte  
Kolbendichtung

PTFE kohlegefüllt  
Feder rostfreier  
Stahl

Hydrauliköl heiße Luft Wasser Dampf	-150°C - +250°C ≤ 350 bar ≤ 15.0 m/sec
--	---

Seite

75

Spring Loaded  
Piston Seal

PTFE  
Stainless Steel  
Spring

Hydraulic oils, hot air, water, stream	-150°C - +250°C ≤ 350 bar ≤ 15.0 m/sec
---	---

Page  
75



DTH-PI-1504  
PTFE-NB

Rotations  
Kolbendichtung

NBR  
PTFE

Mineralöl	-30°C - +105°C ≤ 300 bar ≤ 5.0 m/sec
-----------	---

Seite

HFA und HFB	+5°C - +60°C ≤ 300 bar ≤ 5.0 m/sec
----------------	---------------------------------------

82

HFC	-30°C - +60°C ≤ 300 bar ≤ 5.0 m/sec
-----	--

Piston Seal for  
Rotating Application

NBR  
PTFE

Mineral oils	-30°C - +105°C ≤ 300 bar ≤ 5.0 m/sec
-----------------	---

Page

HFA and HFB	+5°C - +60°C ≤ 300 bar ≤ 5.0 m/sec
----------------	---------------------------------------

82

HFC	-30°C - +60°C ≤ 300 bar ≤ 5.0 m/sec
-----	--

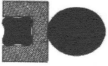

DTH-PI-1506  
PTFE-NBR

Kolbendichtung

NBR  
PTFE

Mineralöl	-30°C - +105°C ≤ 400 bar ≤ 2.0 m/sec
HFA und HFB	+5°C - +60°C ≤ 400 bar ≤ 2.0 m/sec
HFC	-30°C - +60°C ≤ 400 bar ≤ 2.0 m/sec

Seite

83

Piston Seal

NBR  
PTFE

Mineral oils	-30°C - +105°C ≤ 400 bar ≤ 2.0 m/sec
HFA and HFB	+5°C - +60°C ≤ 400 bar ≤ 2.0 m/sec
HFC	-30°C - +60°C ≤ 400 bar ≤ 2.0 m/sec

Page

83



DTH-PI-1510  
PTFE-NBR

Kolbendichtung

NBR  
PTFE

Mineralöl	-30°C - +105°C ≤ 400 bar ≤ 5.0 m/sec
HFA und HFB	+5°C - +60°C ≤ 400 bar ≤ 5.0 m/sec
HFC	-30°C - +60°C ≤ 400 bar ≤ 5.0 m/sec

Seite

78

Piston Seal

NBR  
PTFE

Mineral oils	-30°C - +105°C ≤ 400 bar ≤ 5.0 m/sec
HFA and HFB	+5°C - +60°C ≤ 400 bar ≤ 5.0 m/sec
HFC	-30°C - +60°C ≤ 400 bar ≤ 5.0 m/sec

Page

78



DTH-FB-  
PTFE/BZ

Führungsband

PTFE (Bronze)

Mineralöl	-60°C - +200°C ≤ 15 N/mm <sup>2</sup> ≤ 15.0 m/sec
HFD	-40°C - +200°C ≤ 15 N/mm <sup>2</sup> ≤ 15.0 m/sec

Seite

108

Piston Rod  
Guide Strip

PTFE bronze filled

Mineral oils	-60°C - +200°C ≤ 15 N/mm <sup>2</sup> ≤ 15.0 m/sec
HFD	-40°C - +200°C ≤ 15 N/mm <sup>2</sup> ≤ 15.0 m/sec

Page

108



DTH-FB-PTFE/  
CARBON

Führungsband

PTFE (kohlegefüllt)

Mineralöl	-60°C - +200°C ≤ 8 N/mm <sup>2</sup> ≤ 15.0 m/sec
-----------	--

Seite

108

Piston Rod  
Guide Strip

PTFE carbon filled

Mineral oils	-60°C - +200°C ≤ 8 N/mm <sup>2</sup> ≤ 15.0 m/sec
--------------	--

Page

108



DTH-FB-PO-PT

Führungsband

Polyesterharz

Mineralöl	-40°C - +120°C ≤ 100 n/mm <sup>2</sup> ≤ 1.0 m/sec
HFA und HFB	+5°C - +60°C ≤ 100 n/mm <sup>2</sup> ≤ 1.0 m/sec
HFC	-40°C - +40°C ≤ 100 n/mm <sup>2</sup> ≤ 1.0 m/sec

Seite

109

Piston Rod  
Guide Strip

Polyester Resin

Mineral oils	-40°C - +120°C ≤ 100 n/mm <sup>2</sup> ≤ 1.0 m/sec
HFA and HFB	+5°C - +60°C ≤ 100 n/mm <sup>2</sup> ≤ 1.0 m/sec
HFC	-40°C - +40°C ≤ 100 n/mm <sup>2</sup> ≤ 1.0 m/sec

Page

109

DTH-FB-PHEN Führungsband

Phenolik

Mineralöl | -30°C - +100°C  
≤ 400 bar ≤ 1.0 m/sec

Seite

HFA und  
HFB | +5°C - +50°C  
≤ 400 bar ≤ 1.0 m/sec

109

HFC | -30°C - +40°C  
≤ 400 bar ≤ 1.0 m/sec

Piston Rod  
Guide Strip

Phenolic

Mineral  
oils | -30°C - +100°C  
≤ 400 bar ≤ 1.0 m/sec

Page

HFA and  
HFB | +5°C - +50°C  
≤ 400 bar ≤ 1.0 m/sec

109

HFC | -30°C - +40°C  
≤ 400 bar ≤ 1.0 m/sec

DTH-FB-TELE Teleskop FührungsbandPOM

Mineralöl | -30°C - +100°C  
≤ 400 bar ≤ 1.0 m/sec

Seite

HFA und  
HFB | +5°C - +50°C  
≤ 400 bar ≤ 1.0 m/sec

119

HFC | -30°C - +40°C  
≤ 400 bar ≤ 1.0 m/sec

Telescoping Guide  
Ring

POM

Mineral  
oils | -30°C - +100°C  
≤ 400 bar ≤ 1.0 m/sec

Page

HFA and  
HFB | +5°C - +50°C  
≤ 400 bar ≤ 1.0 m/sec

119

HFC | -30°C - +40°C  
≤ 400 bar ≤ 1.0 m/sec



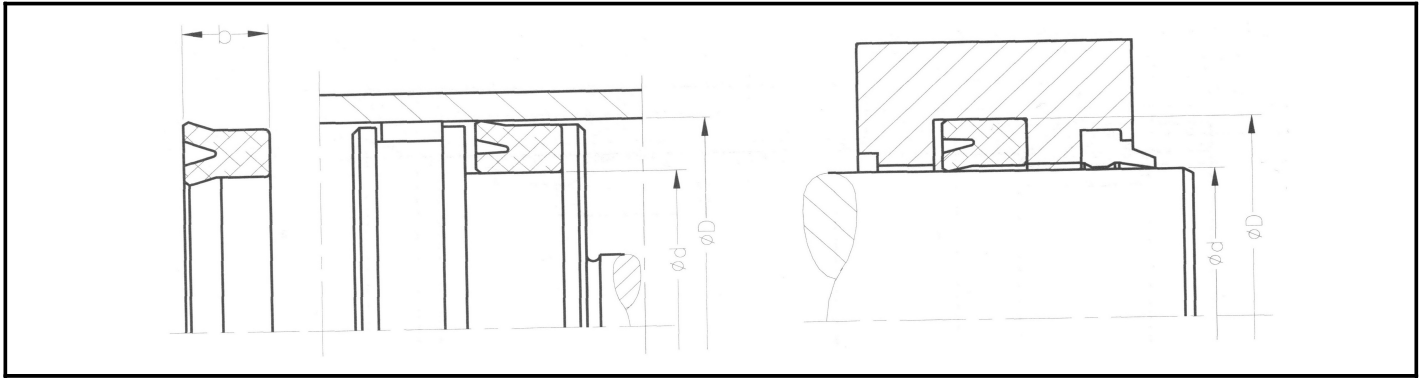

## D TH -PIR O-42000-NB

## Kolben und Stangendichtung / Piston Rod Seal

Nummer:	d	D	b	Nummer:	d	D	b
PIRO-42000-NB 0006-2	3	- 8	- 3,5	PIRO-42000-NB 0014-5	7	- 12	- 4
PIRO-42000-NB 0006-4	3	- 10	- 6	PIRO-42000-NB 0014-6	7	- 11	- 3,5
PIRO-42000-NB 0006-5	3	- 8	- 4,5	PIRO-42000-NB 0014-7	7	- 13	- 4,5
PIRO-42000-NB 0008	4	- 10	- 5	PIRO-42000-NB 0016	8	- 18	- 8
PIRO-42000-NB 0008-1	4	- 12	- 5,5	PIRO-42000-NB 0016-1	8	- 14	- 6
PIRO-42000-NB 0008-2	4	- 12	- 4	PIRO-42000-NB 0016-10	8	- 15	- 6
PIRO-42000-NB 0008-3	4	- 10	- 4	PIRO-42000-NB 0016-11	8	- 20	- 8
PIRO-42000-NB 0008-4	4	- 7,5	- 3	PIRO-42000-NB 0016-12	8	- 17	- 6
PIRO-42000-NB 0008-5	4	- 10	- 4,5	PIRO-42000-NB 0016-2	8	- 16	- 6
PIRO-42000-NB 0008-6	4	- 10	- 6	PIRO-42000-NB 0016-3	8	- 16	- 8
PIRO-42000-NB 0010	5	- 11	- 7	PIRO-42000-NB 0016-5	8	- 14	- 4
PIRO-42000-NB 0010-2	5	- 11	- 5	PIRO-42000-NB 0016-7	8	- 15	- 8
PIRO-42000-NB 0010-3	5	- 10	- 4	PIRO-42000-NB 0016-8	8	- 12	- 5
PIRO-42000-NB 0010-4	5	- 10	- 5	PIRO-42000-NB 0016-9	8	- 13	- 7
PIRO-42000-NB 0010-5	5	- 9	- 2,4	PIRO-42000-NB 0016-13	8	- 15	- 5,2
PIRO-42000-NB 0010-6	5	- 12	- 5	PIRO-42000-NB 0016-14	8	- 15	- 2,5
PIRO-42000-NB 0010-7	5	- 14	- 4,5	PIRO-42000-NB 0016-16	8	- 12	- 4
PIRO-42000-NB 0010-8	5	- 12	- 4	PIRO-42000-NB 0016-17	8	- 14	- 3,5
PIRO-42000-NB 0010-9	5	- 14	- 8	PIRO-42000-NB 0018	9	- 17	- 6
PIRO-42000-NB 0012	6	- 9	- 2	PIRO-42000-NB 0018-1	9	- 19	- 6
PIRO-42000-NB 0012-1	6	- 12	- 6	PIRO-42000-NB 0018-2	9	- 16	- 4
PIRO-42000-NB 0012-2	6	- 12	- 7	PIRO-42000-NB 0018-3	9	- 16	- 7
PIRO-42000-NB 0012-3	6	- 10	- 3	PIRO-42000-NB 0018-4	9	- 17	- 5,5
PIRO-42000-NB 0012-4	6	- 15	- 5	PIRO-42000-NB 0018-5	9	- 14	- 3,5
PIRO-42000-NB 0012-5	6	- 16	- 6	PIRO-42000-NB 0020	10	- 20	- 8
PIRO-42000-NB 0012-6	6	- 12	- 4	PIRO-42000-NB 0020-10	10	- 15	- 4
PIRO-42000-NB 0012-8	6	- 18	- 8	PIRO-42000-NB 0020-11	10	- 16	- 6
PIRO-42000-NB 0012-9	6	- 13	- 5,5	PIRO-42000-NB 0020-12	10	- 16	- 5
PIRO-42000-NB 0012-10	6	- 14	- 6	PIRO-42000-NB 0020-13	10	- 20	- 7
PIRO-42000-NB 0012-11	6	- 20	- 8	PIRO-42000-NB 0020-14	10	- 22	- 9
PIRO-42000-NB 0012-12	6	- 14	- 4	PIRO-42000-NB 0020-16	10	- 14	- 3,5
PIRO-42000-NB 0012-13	6	- 16	- 5	PIRO-42000-NB 0020-17	10	- 20	- 6,5
PIRO-42000-NB 0012-14	6	- 12	- 5	PIRO-42000-NB 0020-18	10	- 26	- 8
PIRO-42000-NB 0014	7	- 15	- 5	PIRO-42000-NB 0020-19	10	- 22	- 6
PIRO-42000-NB 0014-1	7	- 14	- 7	PIRO-42000-NB 0020-20	10	- 18	- 4
PIRO-42000-NB 0014-2	7	- 12,5	- 3,5	PIRO-42000-NB 0020-21	10	- 20	- 6
PIRO-42000-NB 0014-3	7	- 15	- 7	PIRO-42000-NB 0020-22	10	- 18	- 5,5
PIRO-42000-NB 0014-4	7	- 13	- 3,5	PIRO-42000-NB 0020-2	10	- 18	- 8

**DTH-PIRO-42000-NB****Kolben und Stangendichtung / Piston Rod Seal**

Nummer:	d	D	b	Nummer:	d	D	b
PIRO-42000-NB 0020-3	10	- 28	- 10	PIRO-42000-NB 0030-12	15	- 28	- 10
PIRO-42000-NB 0020-4	10	- 18	- 6	PIRO-42000-NB 0030-13	15	- 30	- 10
PIRO-42000-NB 0020-5	10	- 22	- 8	PIRO-42000-NB 0030-15	15	- 30	- 8
PIRO-42000-NB 0020-6	10	- 16	- 4	PIRO-42000-NB 0030-16	15	- 25	- 6
PIRO-42000-NB 0020-7	10	- 25	- 8	PIRO-42000-NB 0030-17	15	- 22	- 5,5
PIRO-42000-NB 0020-8	10	- 25	- 10	PIRO-42000-NB 0030-18	15	- 22	- 8
PIRO-42000-NB 0020-9	10	- 26	- 9,5	PIRO-42000-NB 0030-2	15	- 28	- 8
PIRO-42000-NB 0024	12	- 22	- 8	PIRO-42000-NB 0030-4	15	- 25	- 5
PIRO-42000-NB 0024-1	12	- 20	- 8	PIRO-42000-NB 0030-5	15	- 22	- 4
PIRO-42000-NB 0024-10	12	- 18	- 3	PIRO-42000-NB 0030-6	15	- 30	- 6
PIRO-42000-NB 0024-11	12	- 20	- 5	PIRO-42000-NB 0030-7	15	- 20	- 3
PIRO-42000-NB 0024-12	12	- 25	- 8	PIRO-42000-NB 0030-8	15	- 25	- 10
PIRO-42000-NB 0024-14	12	- 24	- 6	PIRO-42000-NB 0032	16	- 26	- 8
PIRO-42000-NB 0024-15	12	- 28	- 10	PIRO-42000-NB 0032-1	16	- 22	- 5
PIRO-42000-NB 0024-16	12	- 16	- 3	PIRO-42000-NB 0032-10	16	- 25	- 5
PIRO-42000-NB 0024-17	12	- 22	- 7	PIRO-42000-NB 0032-11	16	- 24	- 5,5
PIRO-42000-NB 0024-20	12	- 17	- 3	PIRO-42000-NB 0032-13	16	- 24	- 6
PIRO-42000-NB 0024-21	12	- 20	- 6,8	PIRO-42000-NB 0032-14	16	- 22	- 10
PIRO-42000-NB 0024-23	12	- 26	- 10	PIRO-42000-NB 0032-16	16	- 28	- 6
PIRO-42000-NB 0024-24	12	- 32	- 10	PIRO-42000-NB 0032-17	16	- 22	- 4,5
PIRO-42000-NB 0024-25	12	- 19,5	- 7	PIRO-42000-NB 0032-18	16	- 22	- 6
PIRO-42000-NB 0024-2	12	- 22	- 6	PIRO-42000-NB 0032-19	16	- 22	- 7
PIRO-42000-NB 0024-3	12	- 24	- 7	PIRO-42000-NB 0032-2	16	- 26	- 6
PIRO-42000-NB 0024-4	12	- 24	- 10	PIRO-42000-NB 0032-4	16	- 32	- 10
PIRO-42000-NB 0024-5	12	- 18	- 6	PIRO-42000-NB 0032-5	16	- 24	- 4
PIRO-42000-NB 0024-6	12	- 22	- 5	PIRO-42000-NB 0032-6	16	- 22	- 3
PIRO-42000-NB 0024-7	12	- 18	- 4	PIRO-42000-NB 0032-7	16	- 29	- 6
PIRO-42000-NB 0024-8	12	- 18	- 5	PIRO-42000-NB 0032-8	16	- 26	- 5
PIRO-42000-NB 0024-9	12	- 20	- 5,5	PIRO-42000-NB 0032-9	16	- 22	- 4
PIRO-42000-NB 0026-1	13	- 25	- 8	PIRO-42000-NB 0034-1	17	- 32	- 10
PIRO-42000-NB 0026-2	13	- 20	- 6	PIRO-42000-NB 0034-2	17	- 25	- 4
PIRO-42000-NB 0028	14	- 24	- 8	PIRO-42000-NB 0036	18	- 28	- 8
PIRO-42000-NB 0028-1	14	- 22	- 5	PIRO-42000-NB 0036-1	18	- 30	- 6
PIRO-42000-NB 0028-2	14	- 22	- 12	PIRO-42000-NB 0036-10	18	- 28	- 6
PIRO-42000-NB 0028-3	14	- 24	- 6	PIRO-42000-NB 0036-11	18	- 24	- 8
PIRO-42000-NB 0028-4	14	- 28	- 10	PIRO-42000-NB 0036-12	18	- 26	- 4
PIRO-42000-NB 0028-5	14	- 22	- 8	PIRO-42000-NB 0036-13	18	- 26	- 6
PIRO-42000-NB 0028-6	14	- 20	- 5	PIRO-42000-NB 0036-2	18	- 30	- 7,5
PIRO-42000-NB 0028-7	14	- 20	- 6	PIRO-42000-NB 0036-3	18	- 30	- 8,5
PIRO-42000-NB 0028-8	14	- 20	- 4	PIRO-42000-NB 0036-4	18	- 30	- 10
PIRO-42000-NB 0028-9	14	- 22	- 4	PIRO-42000-NB 0036-5	18	- 25	- 5,5
PIRO-42000-NB 0028-10	14	- 32	- 8	PIRO-42000-NB 0036-6	18	- 32	- 7
PIRO-42000-NB 0028-11	14	- 22	- 6	PIRO-42000-NB 0036-7	18	- 25	- 5
PIRO-42000-NB 0028-12	14	- 28	- 7	PIRO-42000-NB 0036-8	18	- 24	- 4
PIRO-42000-NB 0028-13	14	- 24	- 5	PIRO-42000-NB 0036-9	18	- 26	- 5
PIRO-42000-NB 0028-14	14	- 26	- 8	PIRO-42000-NB 0038-3	19	- 25	- 6
PIRO-42000-NB 0028-15	14	- 22	- 8	PIRO-42000-NB 0038-6	19	- 27	- 4
PIRO-42000-NB 0030	15	- 25	- 8	PIRO-42000-NB 0040	20	- 30	- 8
PIRO-42000-NB 0030-10	15	- 21	- 3,5	PIRO-42000-NB 0040-1	20	- 28	- 5
PIRO-42000-NB 0030-11	15	- 22	- 5	PIRO-42000-NB 0040-10	20	- 25	- 3,5

**DTH-PIRO-42000-NB****Kolben und Stangendichtung / Piston Rod Seal**

Nummer:	d	D	b	Nummer:	d	D	b
PIRO-42000-NB 0040-11	20	- 30	- 4	PIRO-42000-NB 0050-20	25	- 40	- 7,5
PIRO-42000-NB 0040-12	20	- 26	- 6	PIRO-42000-NB 0050-21	25	- 47	- 7
PIRO-42000-NB 0040-14	20	- 27	- 6	PIRO-42000-NB 0050-22	25	- 32	- 5
PIRO-42000-NB 0040-15	20	- 36	- 10	PIRO-42000-NB 0050-23	25	- 35	- 10
PIRO-42000-NB 0040-16	20	- 40	- 12	PIRO-42000-NB 0050-26	25	- 36	- 6,9
PIRO-42000-NB 0040-17	20	- 32	- 7,5	PIRO-42000-NB 0050-27	25	- 38	- 9,5
PIRO-42000-NB 0040-18	20	- 32	- 11	PIRO-42000-NB 0050-2	25	- 33	- 5
PIRO-42000-NB 0040-19	20	- 35	- 12	PIRO-42000-NB 0050-3	25	- 35	- 5
PIRO-42000-NB 0040-21	20	- 28	- 8	PIRO-42000-NB 0050-4	25	- 35	- 7
PIRO-42000-NB 0040-22	20	- 32	- 6	PIRO-42000-NB 0050-5	25	- 35	- 8
PIRO-42000-NB 0040-23	20	- 28	- 6	PIRO-42000-NB 0050-6	25	- 37	- 7
PIRO-42000-NB 0040-24	20	- 25	- 2,5	PIRO-42000-NB 0050-7	25	- 38	- 9
PIRO-42000-NB 0040-25	20	- 30	- 5	PIRO-42000-NB 0050-8	25	- 45	- 10
PIRO-42000-NB 0040-26	20	- 27	- 5	PIRO-42000-NB 0050-9	25	- 32	- 7
PIRO-42000-NB 0040-27	20	- 25	- 5	PIRO-42000-NB 0052-1	26	- 42	- 8
PIRO-42000-NB 0040-2	20	- 30	- 6	PIRO-42000-NB 0052-2	26	- 35	- 8
PIRO-42000-NB 0040-3	20	- 30	- 10	PIRO-42000-NB 0052-3	26	- 38	- 10
PIRO-42000-NB 0040-4	20	- 35	- 10	PIRO-42000-NB 0054	27	- 35	- 4
PIRO-42000-NB 0040-5	20	- 40	- 10	PIRO-42000-NB 0054-1	27	- 38	- 6
PIRO-42000-NB 0040-6	20	- 32	- 5	PIRO-42000-NB 0054-2	27	- 36	- 6
PIRO-42000-NB 0040-7	20	- 36	- 8	PIRO-42000-NB 0054-3	27	- 35	- 6
PIRO-42000-NB 0040-8	20	- 28	- 4	PIRO-42000-NB 0056	28	- 43	- 10
PIRO-42000-NB 0040-9	20	- 25	- 3	PIRO-42000-NB 0056-1	28	- 40	- 10
PIRO-42000-NB 0044	22	- 32	- 8	PIRO-42000-NB 0056-2	28	- 48	- 10
PIRO-42000-NB 0044-1	22	- 32	- 7	PIRO-42000-NB 0056-3	28	- 48	- 12
PIRO-42000-NB 0044-11	22	- 30	- 5	PIRO-42000-NB 0056-4	28	- 35	- 6
PIRO-42000-NB 0044-12	22	- 38	- 10	PIRO-42000-NB 0056-5	28	- 36	- 6
PIRO-42000-NB 0044-14	22	- 32	- 5	PIRO-42000-NB 0056-6	28	- 36	- 5
PIRO-42000-NB 0044-15	22	- 30	- 10	PIRO-42000-NB 0056-7	28	- 35,5	- 5
PIRO-42000-NB 0044-17	22	- 46	- 12	PIRO-42000-NB 0056-8	28	- 38	- 10
PIRO-42000-NB 0044-18	22,4	- 30	- 5	PIRO-42000-NB 0056-9	28	- 44	- 8
PIRO-42000-NB 0044-4	22	- 34	- 6	PIRO-42000-NB 0056-10	28	- 38	- 5
PIRO-42000-NB 0044-5	22	- 30	- 6	PIRO-42000-NB 0056-12	28	- 48	- 8,5
PIRO-42000-NB 0044-6	22	- 42	- 10	PIRO-42000-NB 0056-13	28	- 36	- 4
PIRO-42000-NB 0044-7	22	- 34	- 10	PIRO-42000-NB 0056-14	28	- 40	- 6
PIRO-42000-NB 0044-8	22	- 32	- 6	PIRO-42000-NB 0056-15	28	- 35	- 5
PIRO-42000-NB 0044-9	22	- 40	- 10	PIRO-42000-NB 0060-5	30	- 40	- 5
PIRO-42000-NB 0048	24	- 34	- 5	PIRO-42000-NB 0060-7	30	- 38	- 4
PIRO-42000-NB 0048-1	24	- 32	- 4	PIRO-42000-NB 0060-8	30	- 38	- 5,5
PIRO-42000-NB 0048-2	24	- 40	- 8	PIRO-42000-NB 0060	30	- 45	- 10
PIRO-42000-NB 0048-4	24	- 36	- 6,3	PIRO-42000-NB 0060-1	30	- 40	- 10
PIRO-42000-NB 0050	25	- 40	- 10	PIRO-42000-NB 0060-10	30	- 37	- 8
PIRO-42000-NB 0050-11	25	- 33	- 4	PIRO-42000-NB 0060-11	30	- 38	- 10
PIRO-42000-NB 0050-12	25	- 38	- 7	PIRO-42000-NB 0030-12	30	- 47	- 10
PIRO-42000-NB 0050-14	25	- 38	- 10	PIRO-42000-NB 0060-14	30	- 38	- 3
PIRO-42000-NB 0050-15	25	- 50	- 12	PIRO-42000-NB 0060-15	30	- 40	- 8
PIRO-42000-NB 0050-16	25	- 32	- 4	PIRO-42000-NB 0060-16	30	- 36	- 3
PIRO-42000-NB 0050-17	25	- 33	- 7	PIRO-42000-NB 0060-17	30,16	- 38,1	- 3,97
PIRO-42000-NB 0050-18	25	- 40	- 11	PIRO-42000-NB 0060-18	30	- 37	- 6
PIRO-42000-NB 0050-19	25	- 35	- 6	PIRO-42000-NB 0060-20	30	- 45	- 12

**DTH-PIRO-42000-NB**

**Kolben und Stangendichtung / Piston Rod Seal**

Nummer:	d	D	b	Nummer:	d	D	b
PIRO-42000-NB 0060-21	30	- 38	- 8	PIRO-42000-NB 0076-9	38	- 48	- 7,5
PIRO-42000-NB 0060-2	30	- 42	- 10	PIRO-42000-NB 0080	40	- 55	- 10
PIRO-42000-NB 0060-3	30	- 50	- 10	PIRO-42000-NB 0080-1	40	- 50	- 6
PIRO-42000-NB 0060-4	30	- 50	- 12	PIRO-42000-NB 0080-10	40	- 50	- 5
PIRO-42000-NB 0060-6	30	- 40	- 7	PIRO-42000-NB 0080-11	40	- 50	- 8
PIRO-42000-NB 0060-9	30	- 40	- 6	PIRO-42000-NB 0080-12	40	- 65	- 10
PIRO-42000-NB 0064	32	- 47	- 10	PIRO-42000-NB 0080-13	40	- 56	- 8
PIRO-42000-NB 0064-1	32	- 40	- 8	PIRO-42000-NB 0080-2	40	- 50	- 10
PIRO-42000-NB 0064-10	32	- 52	- 10	PIRO-42000-NB 0080-3	40	- 52	- 12
PIRO-42000-NB 0064-11	32	- 44	- 6	PIRO-42000-NB 0080-4	40	- 60	- 10
PIRO-42000-NB 0064-3	32	- 42	- 6	PIRO-42000-NB 0080-5	40	- 60	- 12
PIRO-42000-NB 0064-4	32	- 45	- 10	PIRO-42000-NB 0080-6	40	- 50	- 9
PIRO-42000-NB 0064-5	32	- 50	- 12	PIRO-42000-NB 0080-7	40	- 50	- 7
PIRO-42000-NB 0064-6	32	- 40	- 4	PIRO-42000-NB 0080-8	40	- 56	- 10
PIRO-42000-NB 0064-7	32	- 40	- 5	PIRO-42000-NB 0080-9	40	- 65	- 15
PIRO-42000-NB 0064-8	32	- 44	- 6,35	PIRO-42000-NB 0080-14	40	- 48	- 11
PIRO-42000-NB 0064-9	32	- 40	- 5,7	PIRO-42000-NB 0080-15	40	- 55	- 7
PIRO-42000-NB 0064-13	32	- 48	- 10	PIRO-42000-NB 0080-16	40	- 52	- 6
PIRO-42000-NB 0064-14	32	- 40	- 10	PIRO-42000-NB 0080-18	40	- 55	- 12
PIRO-42000-NB 0064-15	32	- 50	- 10	PIRO-42000-NB 0084-1	42	- 50	- 5
PIRO-42000-NB 0066	33	- 43	- 6	PIRO-42000-NB 0084-2	42	- 62	- 12
PIRO-42000-NB 0068	34	- 44	- 5	PIRO-42000-NB 0084-3	42	- 57	- 8
PIRO-42000-NB 0070	35	- 50	- 10	PIRO-42000-NB 0084-4	42	- 55	- 8
PIRO-42000-NB 0070-2	35	- 45	- 10	PIRO-42000-NB 0084-5	42	- 50	- 8
PIRO-42000-NB 0070-3	35	- 55	- 10	PIRO-42000-NB 0084-6	42	- 51	- 11
PIRO-42000-NB 0070-4	35	- 55	- 12	PIRO-42000-NB 0084-7	42	- 52	- 10
PIRO-42000-NB 0070-5	35	- 43	- 6	PIRO-42000-NB 0084-8	42	- 50	- 6
PIRO-42000-NB 0070-6	35	- 52	- 12	PIRO-42000-NB 0086	43	- 63	- 10
PIRO-42000-NB 0070-7	35	- 45	- 6	PIRO-42000-NB 0086-1	43	- 64	- 15
PIRO-42000-NB 0070-8	35	- 47	- 6	PIRO-42000-NB 0088	44	- 57	- 9
PIRO-42000-NB 0070-9	35	- 50	- 7,5	PIRO-42000-NB 0090	45	- 60	- 10
PIRO-42000-NB 0070-10	35	- 45	- 5	PIRO-42000-NB 0090-1	45	- 55	- 10
PIRO-42000-NB 0070-11	35	- 48	- 8	PIRO-42000-NB 0090-10	45	- 63	- 10
PIRO-42000-NB 0070-12	35	- 45	- 8	PIRO-42000-NB 0090-11	45	- 58	- 10
PIRO-42000-NB 0072	36	- 51	- 10	PIRO-42000-NB 0090-2	45	- 57	- 6
PIRO-42000-NB 0072-1	36	- 51	- 7,1	PIRO-42000-NB 0090-3	45	- 63	- 12
PIRO-42000-NB 0072-2	36	- 50	- 8	PIRO-42000-NB 0090-4	45	- 65	- 10
PIRO-42000-NB 0072-3	36	- 46	- 7	PIRO-42000-NB 0090-5	45	- 65	- 12
PIRO-42000-NB 0072-4	36	- 48	- 6	PIRO-42000-NB 0090-7	45	- 55	- 6
PIRO-42000-NB 0072-5	36	- 46	- 6	PIRO-42000-NB 0090-9	45	- 53	- 8
PIRO-42000-NB 0072-6	36	- 48	- 10	PIRO-42000-NB 0090-12	45	- 56	- 7
PIRO-42000-NB 0072-7	36	- 46	- 5	PIRO-42000-NB 0090-13	45	- 55	- 8
PIRO-42000-NB 0074	37	- 45	- 5,5	PIRO-42000-NB 0090-14	45	- 55	- 6,5
PIRO-42000-NB 0076	38	- 52,5	- 9,5	PIRO-42000-NB 0090-6	45	- 70	- 12
PIRO-42000-NB 0076-1	38	- 55	- 10	PIRO-42000-NB 0090-8	45	- 53	- 7
PIRO-42000-NB 0076-2	38	- 58	- 10	PIRO-42000-NB 0092	46	- 70	- 12
PIRO-42000-NB 0076-3	38	- 50	- 6	PIRO-42000-NB 0092-1	46	- 58	- 6
PIRO-42000-NB 0076-4	38	- 50	- 10	PIRO-42000-NB 0094	47	- 65	- 12
PIRO-42000-NB 0076-7	38	- 45	- 6	PIRO-42000-NB 0094-2	47	- 60	- 8
PIRO-42000-NB 0076-8	38	- 50	- 9	PIRO-42000-NB 0094-3	47	- 63	- 8

**DTH-PIRO-42000-NB**
**Kolben und Stangendichtung / Piston Rod Seal**

Nummer:	d	D	b	Nummer:	d	D	b
PIRO-42000-NB 0096	48	- 63	- 12	PIRO-42000-NB 00112-5	56	- 70	- 12
PIRO-42000-NB 0096-1	48	- 60	- 9	PIRO-42000-NB 00112-6	56	- 66	- 6
PIRO-42000-NB 0096-2	48	- 68	- 12	PIRO-42000-NB 00112-7	56	- 68	- 7
PIRO-42000-NB 0096-3	48	- 58	- 6,5	PIRO-42000-NB 00116-1	58	- 70	- 6
PIRO-42000-NB 0096-4	48	- 68	- 10	PIRO-42000-NB 00116-2	58	- 78	- 12
PIRO-42000-NB 0096-5	48	- 60	- 6	PIRO-42000-NB 00118	59	- 80	- 14
PIRO-42000-NB 0096-6	48	- 63	- 10	PIRO-42000-NB 00120	60	- 80	- 12
PIRO-42000-NB 0100	50	- 65	- 10	PIRO-42000-NB 00120-1	60	- 80	- 10
PIRO-42000-NB 0100-1	50	- 60	- 10	PIRO-42000-NB 00120-2	60	- 70	- 12
PIRO-42000-NB 0100-11	50	- 60	- 8	PIRO-42000-NB 00120-3	60	- 80	- 16
PIRO-42000-NB 0100-12	50	- 58	- 8	PIRO-42000-NB 00120-4	60	- 75	- 12
PIRO-42000-NB 0100-13	50	- 60	- 6	PIRO-42000-NB 00120-5	60	- 70	- 13
PIRO-42000-NB 0100-14	50	- 60	- 12	PIRO-42000-NB 00120-6	60	- 70	- 6
PIRO-42000-NB 0100-15	50	- 60	- 7	PIRO-42000-NB 00120-7	60	- 70	- 7
PIRO-42000-NB 0100-16	50	- 57	- 10	PIRO-42000-NB 00120-8	60	- 80	- 12,5
PIRO-42000-NB 0100-18	50	- 63	- 6	PIRO-42000-NB 00122	61	- 80	- 12
PIRO-42000-NB 0100-19	50	- 62	- 6	PIRO-42000-NB 00122-1	61	- 71	- 6
PIRO-42000-NB 0100-20	50	- 60	- 5	PIRO-42000-NB 00126	63	- 83	- 12
PIRO-42000-NB 0100-21	50	- 60	- 4	PIRO-42000-NB 00126-2	63	- 72	- 6
PIRO-42000-NB 0100-24	50	- 63	- 12	PIRO-42000-NB 00126-4	63	- 78	- 8
PIRO-42000-NB 0100-25	50	- 63	- 7	PIRO-42000-NB 00130	65	- 85	- 12
PIRO-42000-NB 0100-2	50	- 62	- 9	PIRO-42000-NB 00130-1	65	- 80	- 12
PIRO-42000-NB 0100-3	50	- 63	- 8	PIRO-42000-NB 00130-5	65	- 75	- 10
PIRO-42000-NB 0100-4	50	- 63	- 9	PIRO-42000-NB 00130-6	65	- 75	- 6
PIRO-42000-NB 0100-5	50	- 65	- 12	PIRO-42000-NB 00130-7	65	- 90	- 12
PIRO-42000-NB 0100-6	50	- 68	- 12	PIRO-42000-NB 00130-8	65	- 75	- 12
PIRO-42000-NB 0100-7	50	- 70	- 8	PIRO-42000-NB 00130-9	65	- 80	- 10
PIRO-42000-NB 0100-8	50	- 70	- 10	PIRO-42000-NB 00130-10	65	- 75	- 7,3
PIRO-42000-NB 0100-9	50	- 70	- 12	PIRO-42000-NB 00130-2	65	- 90	- 8
PIRO-42000-NB 0104	52	- 62	- 12	PIRO-42000-NB 00130-3	65	- 90	- 13
PIRO-42000-NB 0104-1	52	- 62	- 6	PIRO-42000-NB 00130-4	65	- 90	- 15
PIRO-42000-NB 0106-2	53	- 63	- 12	PIRO-42000-NB 00132	66	- 77	- 6
PIRO-42000-NB 0106-3	53	- 63	- 7,5	PIRO-42000-NB 00136	68	- 80	- 12
PIRO-42000-NB 0106-4	53	- 64	- 5	PIRO-42000-NB 00136-2	68	- 80	- 10
PIRO-42000-NB 0106-5	53	- 63	- 6	PIRO-42000-NB 00140	70	- 90	- 12
PIRO-42000-NB 0106-6	53	- 63	- 10	PIRO-42000-NB 00140-1	70	- 80	- 12
PIRO-42000-NB 0108	54	- 70	- 8	PIRO-42000-NB 00140-2	70	- 85	- 8
PIRO-42000-NB 0110	55	- 75	- 12	PIRO-42000-NB 00140-4	70	- 85	- 12
PIRO-42000-NB 0110-1	55	- 70	- 10	PIRO-42000-NB 00140-6	70	- 100	- 15
PIRO-42000-NB 0110-3	55	- 70	- 12	PIRO-42000-NB 00140-7	70	- 90	- 10
PIRO-42000-NB 0110-4	55	- 80	- 15	PIRO-42000-NB 00140-8	70	- 80	- 7
PIRO-42000-NB 0110-5	55	- 65	- 12	PIRO-42000-NB 00140-9	70	- 80	- 6
PIRO-42000-NB 0110-6	55	- 80	- 12	PIRO-42000-NB 00140-11	70	- 85	- 7,5
PIRO-42000-NB 0110-7	55	- 65	- 5	PIRO-42000-NB 00142-1	71,43	- 82,55	- 5,5
PIRO-42000-NB 0110-8	55	- 70	- 7,5	PIRO-42000-NB 00144	72	- 80	- 10
PIRO-42000-NB 0110-9	55	- 65	- 6	PIRO-42000-NB 00144-1	72	- 90	- 10
PIRO-42000-NB 0112	56	- 76	- 12	PIRO-42000-NB 00144-2	72	- 82	- 5
PIRO-42000-NB 0112-2	56	- 80	- 15	PIRO-42000-NB 00150	75	- 95	- 12
PIRO-42000-NB 0112-3	56	- 71	- 10	PIRO-42000-NB 00150-1	75	- 85	- 12
PIRO-42000-NB 0112-4	56	- 66	- 5	PIRO-42000-NB 00150-2	75	- 90	- 12

**DTH-PIRO-42000-NB**
**Kolben und Stangendichtung / Piston Rod Seal**

Nummer:	d	D	b	Nummer:	d	D	b
PIRO-42000-NB 00150-4	75	- 83	- 12	PIRO-42000-NB 0200-2	100	- 120	- 15
PIRO-42000-NB 00150-5	75	- 95	- 10	PIRO-42000-NB 0200-3	100	- 130	- 18
PIRO-42000-NB 00150-7	75	- 100	- 15	PIRO-42000-NB 0200-6	100	- 130	- 15
PIRO-42000-NB 00150-8	75	- 85	- 6	PIRO-42000-NB 0200-9	100	- 115	- 9
PIRO-42000-NB 00156	78	- 88	- 5	PIRO-42000-NB 0206	103	- 125	- 14
PIRO-42000-NB 00160-1	80	- 95	- 8	PIRO-42000-NB 0210	105	- 130	- 15
PIRO-42000-NB 00160-2	80	- 95	- 9	PIRO-42000-NB 0214	107	- 127,4	- 16
PIRO-42000-NB 00160-3	80	- 95	- 12	PIRO-42000-NB 0220	110	- 135	- 18
PIRO-42000-NB 00160-7	80	- 90	- 7	PIRO-42000-NB 0220-1	110	- 140	- 18
PIRO-42000-NB 00160-10	80	- 90	- 6	PIRO-42000-NB 0220-2	110	- 125	- 12
PIRO-42000-NB 00160-11	80	- 90	- 5	PIRO-42000-NB 0224	112	- 125	- 9
PIRO-42000-NB 00164-1	82	- 92	- 10	PIRO-42000-NB 0230	115	- 140	- 18
PIRO-42000-NB 00170-3	85	- 95	- 9	PIRO-42000-NB 0230-2	115	- 125	- 8
PIRO-42000-NB 00160	80	- 100	- 12	PIRO-42000-NB 0230-3	115	- 135	- 15
PIRO-42000-NB 00160-12	80	- 105	- 12	PIRO-42000-NB 0230-4	115	- 123	- 12
PIRO-42000-NB 00160-13	80	- 100	- 12,5	PIRO-42000-NB 0230-5	115	- 130	- 10
PIRO-42000-NB 00160-5	80	- 100	- 10	PIRO-42000-NB 0236	118	- 132	- 8,5
PIRO-42000-NB 00160-6	80	- 105	- 15	PIRO-42000-NB 0240	120	- 145	- 18
PIRO-42000-NB 00160-8	80	- 100	- 15	PIRO-42000-NB 0240-1	120	- 150	- 15
PIRO-42000-NB 00164-2	82	- 108	- 12	PIRO-42000-NB 0240-5	120	- 140	- 14
PIRO-42000-NB 00166	83	- 103	- 14	PIRO-42000-NB 0250	125	- 155	- 18
PIRO-42000-NB 00168	84	- 103	- 14	PIRO-42000-NB 0250-1	125	- 150	- 18
PIRO-42000-NB 00170	85	- 105	- 12	PIRO-42000-NB 0250-2	125	- 154	- 20
PIRO-42000-NB 00170-2	85	- 100	- 12	PIRO-42000-NB 0250-5	125	- 155	- 15
PIRO-42000-NB 00170-4	85	- 105	- 15	PIRO-42000-NB 0250-7	125	- 140	- 9
PIRO-42000-NB 00170-5	85	- 105	- 10	PIRO-42000-NB 0254-1	127	- 151	- 16
PIRO-42000-NB 00170-7	85	- 110	- 15	PIRO-42000-NB 0260	130	- 150	- 15
PIRO-42000-NB 00170-8	85	- 100	- 9	PIRO-42000-NB 0260-1	130	- 160	- 18
PIRO-42000-NB 00170-11	85	- 100	- 7,5	PIRO-42000-NB 0260-3	130	- 160	- 15
PIRO-42000-NB 00172	86	- 105	- 16	PIRO-42000-NB 0270	135	- 143	- 12
PIRO-42000-NB 00180	90	- 110	- 12	PIRO-42000-NB 0270-1	135	- 150	- 15
PIRO-42000-NB 00180-2	90	- 100	- 8	PIRO-42000-NB 0270-2	135	- 165	- 15
PIRO-42000-NB 00180-3	90	- 110	- 10	PIRO-42000-NB 0270-3	135	- 160	- 18
PIRO-42000-NB 00180-4	90	- 110	- 15	PIRO-42000-NB 0272	136	- 150	- 9
PIRO-42000-NB 00180-5	90	- 112	- 12	PIRO-42000-NB 0280	140	- 170	- 18
PIRO-42000-NB 00180-6	90	- 115	- 12	PIRO-42000-NB 0280-2	140	- 160	- 8
PIRO-42000-NB 00180-8	90	- 105	- 7,5	PIRO-42000-NB 0280-5	140	- 154	- 10
PIRO-42000-NB 00180-9	90	- 100	- 4	PIRO-42000-NB 0280-6	140	- 155	- 9
PIRO-42000-NB 00180-13	90	- 100	- 5	PIRO-42000-NB 0290	145	- 160	- 8
PIRO-42000-NB 00180-12	90	- 105	- 9	PIRO-42000-NB 0290-1	145	- 170	- 18
PIRO-42000-NB 00190	95	- 103	- 12	PIRO-42000-NB 0290-2	145	- 175	- 18
PIRO-42000-NB 00190-2	95	- 115	- 12	PIRO-42000-NB 0290-3	145	- 165	- 15
PIRO-42000-NB 00190-3	95	- 115	- 15	PIRO-42000-NB 0290-4	145	- 160	- 9
PIRO-42000-NB 00190-4	95	- 120	- 12	PIRO-42000-NB 0290-6	145	- 160	- 10
PIRO-42000-NB 00190-5	95	- 125	- 15	PIRO-42000-NB 0300	150	- 180	- 18
PIRO-42000-NB 00190-6	95	- 110	- 9	PIRO-42000-NB 0300-4	150	- 180	- 15
PIRO-42000-NB 00200-4	100	- 120	- 10	PIRO-42000-NB 0300-5	150	- 170	- 10
PIRO-42000-NB 00200-5	100	- 110	- 5	PIRO-42000-NB 0300-6	150	- 165	- 9
PIRO-42000-NB 00200	100	- 125	- 15	PIRO-42000-NB 0310	155	- 163	- 12
PIRO-42000-NB 00200-1	100	- 120	- 12	PIRO-42000-NB 0310-1	155	- 175	- 15

**DTH-PIRO-42000-NB****Kolben und Stangendichtung / Piston Rod Seal**

Nummer:	d	D	b	Nummer:	d	D	b
PIRO-42000-NB 0320	160	- 190	- 22	PIRO-42000-NB 0450	225	- 250	- 18
PIRO-42000-NB 0320-1	160	- 180	- 15	PIRO-42000-NB 0450-3	225	- 255	- 15
PIRO-42000-NB 0320-2	160	- 190	- 21	PIRO-42000-NB 04810	240	- 260	- 16
PIRO-42000-NB 0320-3	160	- 195	- 17	PIRO-42000-NB 0500-4	250	- 275	- 12
PIRO-42000-NB 0320-4	160	- 168	- 12	PIRO-42000-NB 0500-5	250	- 290	- 20
PIRO-42000-NB 0320-6	160	- 169	- 13,5	PIRO-42000-NB 0538	269	- 290	- 12
PIRO-42000-NB 0320-7	160	- 180	- 10	PIRO-42000-NB 0540-2	270	- 290	- 12
PIRO-42000-NB 0330-3	165	- 180	- 9	PIRO-42000-NB 0560	280	- 310	- 15
PIRO-42000-NB 0336	168	- 180	- 14	PIRO-42000-NB 0580-1	290	- 307	- 14
PIRO-42000-NB 0340	170	- 200	- 15	PIRO-42000-NB 0600-1	300	- 320	- 15
PIRO-42000-NB 0340-1	170	- 200	- 22	PIRO-42000-NB 0480-1	240	- 270	- 18
PIRO-42000-NB 0346-1	173	- 200	- 20	PIRO-42000-NB 0540-1	270	- 300	- 22
PIRO-42000-NB 0360	180	- 210	- 22	PIRO-42000-NB 0638	319	- 340	- 12
PIRO-42000-NB 0360-3	180	- 200	- 12	PIRO-42000-NB 0640	320	- 350	- 15
PIRO-42000-NB 0370	185	- 195	- 12	PIRO-42000-NB 0640-1	320	- 340	- 12
PIRO-42000-NB 0370-1	185	- 200	- 9	PIRO-42000-NB 0720	360	- 420	- 30
PIRO-42000-NB 0380	190	- 220	- 25	PIRO-42000-NB 0750	375	- 395	- 12
PIRO-42000-NB 0380-2	190	- 215	- 20	PIRO-42000-NB 0780	390	- 406	- 14
PIRO-42000-NB 0390	195	- 220	- 16	PIRO-42000-NB 0800	400	- 420	- 15
PIRO-42000-NB 0400	200	- 230	- 22	PIRO-42000-NB 0900	450	- 480	- 15
PIRO-42000-NB 0400-6	200	- 230	- 15	PIRO-42000-NB 0900-1	450	- 482	- 24
PIRO-42000-NB 0420-2	210	- 250	- 20	PIRO-42000-NB 0950	475	- 507	- 24
PIRO-42000-NB 0430	215	- 230	- 7,5	PIRO-42000-NB 1000	500	- 532	- 24
PIRO-42000-NB 0440	220	- 250	- 20				

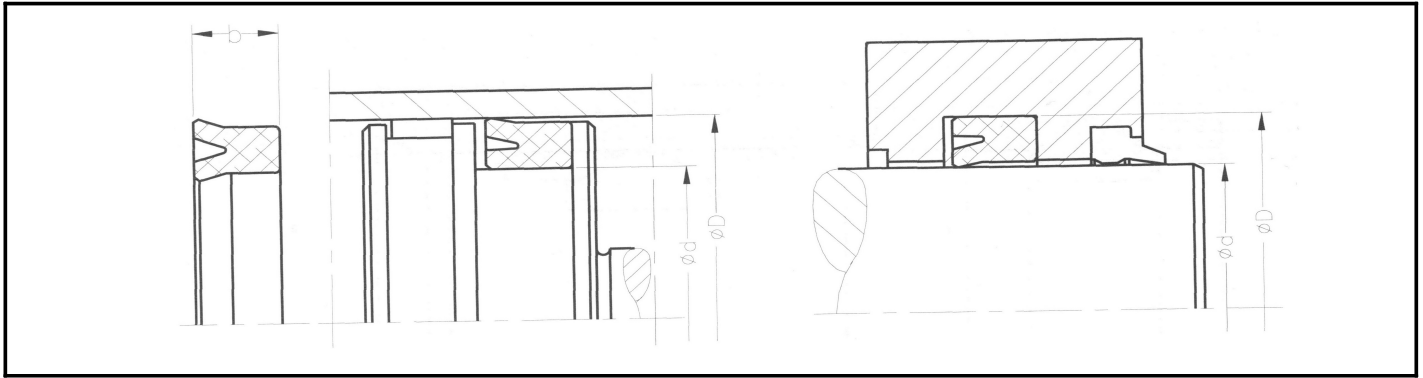

## DTH-PIRO-42000-PU

## Kolben und Stangendichtung / Piston Rod Seal

Nummer:	d	D	b	Nummer:	d	D	b
PIRO-42000-PU 0006-2	3	- 8	- 3,5	PIRO-42000-PU 0018-2	9	- 16	- 4
PIRO-42000-PU 0006-4	3	- 10	- 6	PIRO-42000-PU 0018-3	9	- 16	- 7
PIRO-42000-PU 0008-1	4	- 12	- 5,5	PIRO-42000-PU 0018-4	9	- 17	- 5,5
PIRO-42000-PU 0008-3	4	- 10	- 4	PIRO-42000-PU 0020	10	- 20	- 8
PIRO-42000-PU 0008-6	4	- 10	- 6	PIRO-42000-PU 0020-10	10	- 15	- 4
PIRO-42000-PU 0010	5	- 11	- 7	PIRO-42000-PU 0020-11	10	- 16	- 6
PIRO-42000-PU 0010-2	5	- 11	- 5	PIRO-42000-PU 0020-12	10	- 16	- 5
PIRO-42000-PU 0010-3	5	- 10	- 4	PIRO-42000-PU 0020-13	10	- 20	- 7
PIRO-42000-PU 0010-4	5	- 10	- 5	PIRO-42000-PU 0020-14	10	- 22	- 9
PIRO-42000-PU 0010-6	5	- 12	- 5	PIRO-42000-PU 0020-2	10	- 18	- 8
PIRO-42000-PU 0010-9	5	- 14	- 8	PIRO-42000-PU 0020-3	10	- 28	- 10
PIRO-42000-PU 0012-1	6	- 12	- 6	PIRO-42000-PU 0020-4	10	- 18	- 6
PIRO-42000-PU 0012.2	6	- 12	- 7	PIRO-42000-PU 0020-5	10	- 22	- 8
PIRO-42000-PU 0012-3	6	- 10	- 3	PIRO-42000-PU 0020-6	10	- 16	- 4
PIRO-42000-PU 0012-4	6	- 15	- 5	PIRO-42000-PU 0020-8	10	- 25	- 10
PIRO-42000-PU 0012-5	6	- 16	- 6	PIRO-42000-PU 0020-9	10	- 26	- 9,5
PIRO-42000-PU 0012-6	6	- 12	- 4	PIRO-42000-PU 0020-18	10	- 26	- 8
PIRO-42000-PU 0012-8	6	- 18	- 8	PIRO-42000-PU 0020-19	10	- 22	- 6
PIRO-42000-PU 0012-9	6	- 13	- 5,5	PIRO-42000-PU 0020-20	10	- 18	- 4
PIRO-42000-PU 0012-10	6	- 14	- 6	PIRO-42000-PU 0024-1	12	- 20	- 8
PIRO-42000-PU 0012-11	6	- 20	- 8	PIRO-42000-PU 0024-11	12	- 20	- 5
PIRO-42000-PU 0012-12	6	- 14	- 4	PIRO-42000-PU 0024-5	12	- 18	- 6
PIRO-42000-PU 0012-13	6	- 16	- 5	PIRO-42000-PU 0024-6	12	- 22	- 5
PIRO-42000-PU 0014	7	- 15	- 5	PIRO-42000-PU 0024-7	12	- 18	- 4
PIRO-42000-PU 0014-1	7	- 14	- 7	PIRO-42000-PU 0024-8	12	- 18	- 5
PIRO-42000-PU 0014-3	7	- 15	- 7	PIRO-42000-PU 0024-9	12	- 20	- 5,5
PIRO-42000-PU 0014-4	7	- 13	- 3,5	PIRO-42000-PU 0024	12	- 22	- 8
PIRO-42000-PU 0016	8	- 18	- 8	PIRO-42000-PU 0024-12	12	- 25	- 8
PIRO-42000-PU 0016-1	8	- 14	- 6	PIRO-42000-PU 0012-14	12	- 24	- 6
PIRO-42000-PU 0016-11	8	- 20	- 8	PIRO-42000-PU 0024-15	12	- 28	- 10
PIRO-42000-PU 0016-15	8	- 15	- 5	PIRO-42000-PU 0024-17	12	- 22	- 7
PIRO-42000-PU 0016-16	8	- 12	- 4	PIRO-42000-PU 0024-20	12	- 17	- 3
PIRO-42000-PU 0016-2	8	- 16	- 6	PIRO-42000-PU 0024-23	12	- 26	- 10
PIRO-42000-PU 0016-3	8	- 16	- 8	PIRO-42000-PU 0024-24	12	- 32	- 10
PIRO-42000-PU 0016-5	8	- 14	- 4	PIRO-42000-PU 0024-25	12	- 19,5	- 7
PIRO-42000-PU 0016-7	8	- 15	- 8	PIRO-42000-PU 0024-2	12	- 22	- 6
PIRO-42000-PU 0018	9	- 17	- 6	PIRO-42000-PU 0024-4	12	- 24	- 10
PIRO-42000-PU 0018-1	9	- 19	- 6	PIRO-42000-PU 0026-1	13	- 25	- 8



**DTH-PIRO-42000-PU**

**Kolben und Stangendichtung / Piston Rod Seal**

Nummer:	d	D	b	Nummer:	d	D	b
PIRO-42000-PU 0026-2	13	- 20	- 6	PIRO-42000-PU 0036-3	18	- 30	- 8,5
PIRO-42000-PU 0028	14	- 24	- 8	PIRO-42000-PU 0036-4	18	- 30	- 10
PIRO-42000-PU 0028-1	14	- 22	- 5	PIRO-42000-PU 0036-6	18	- 32	- 7
PIRO-42000-PU 0028-10	14	- 32	- 8	PIRO-42000-PU 0036-7	18	- 25	- 5
PIRO-42000-PU 0028-2	14	- 22	- 12	PIRO-42000-PU 0036-9	18	- 26	- 5
PIRO-42000-PU 0028-3	14	- 24	- 6	PIRO-42000-PU 0038-3	19	- 25	- 6
PIRO-42000-PU 0028-4	14	- 28	- 10	PIRO-42000-PU 0038-6	19	- 27	- 4
PIRO-42000-PU 0028-6	14	- 20	- 5	PIRO-42000-PU 0040	20	- 30	- 8
PIRO-42000-PU 0028-7	14	- 20	- 6	PIRO-42000-PU 0040-1	20	- 28	- 5
PIRO-42000-PU 0028-8	14	- 20	- 4	PIRO-42000-PU 0040-10	20	- 25	- 3,5
PIRO-42000-PU 0028-9	14	- 22	- 4	PIRO-42000-PU 0040-11	20	- 30	- 4
PIRO-42000-PU 0028-11	14	- 22	- 6	PIRO-42000-PU 0040-14	20	- 27	- 6
PIRO-42000-PU 0028-12	14	- 28	- 7	PIRO-42000-PU 0040-15	20	- 36	- 10
PIRO-42000-PU 0028-13	14	- 24	- 5	PIRO-42000-PU 0040-16	20	- 40	- 12
PIRO-42000-PU 0028-14	14	- 26	- 8	PIRO-42000-PU 0040-17	20	- 32	- 7,5
PIRO-42000-PU 0028-15	14	- 22	- 8	PIRO-42000-PU 0040-18	20	- 32	- 11
PIRO-42000-PU 0030	15	- 25	- 8	PIRO-42000-PU 0040-19	20	- 35	- 12
PIRO-42000-PU 0030-10	15	- 21	- 3,5	PIRO-42000-PU 0040-21	20	- 28	- 8
PIRO-42000-PU 0030-12	15	- 28	- 10	PIRO-42000-PU 0040-22	20	- 32	- 6
PIRO-42000-PU 0030-13	15	- 30	- 10	PIRO-42000-PU 0040-23	20	- 28	- 6
PIRO-42000-PU 0030-15	15	- 30	- 8	PIRO-42000-PU 0040-25	20	- 30	- 5
PIRO-42000-PU 0030-17	15	- 22	- 5,5	PIRO-42000-PU 0040-26	20	- 27	- 5
PIRO-42000-PU 0030-18	15	- 22	- 8	PIRO-42000-PU 0040-27	20	- 25	- 5
PIRO-42000-PU 0030-2	15	- 28	- 8	PIRO-42000-PU 0040-2	20	- 30	- 6
PIRO-42000-PU 0030-6	15	- 30	- 6	PIRO-42000-PU 0040-3	20	- 30	- 10
PIRO-42000-PU 0030-7	15	- 20	- 3	PIRO-42000-PU 0040-4	20	- 35	- 10
PIRO-42000-PU 0030-8	15	- 25	- 10	PIRO-42000-PU 0040-5	20	- 40	- 10
PIRO-42000-PU 0032	16	- 26	- 8	PIRO-42000-PU 0040-6	20	- 32	- 5
PIRO-42000-PU 0032-1	16	- 22	- 5	PIRO-42000-PU 0040-7	20	- 36	- 8
PIRO-42000-PU 0032-10	16	- 25	- 5	PIRO-42000-PU 0040-8	20	- 28	- 4
PIRO-42000-PU 0032-13	16	- 24	- 6	PIRO-42000-PU 0040-9	20	- 25	- 3
PIRO-42000-PU 0032-14	16	- 22	- 10	PIRO-42000-PU 0044-5	22	- 30	- 6
PIRO-42000-PU 0032-16	16	- 28	- 6	PIRO-42000-PU 0044	22	- 32	- 8
PIRO-42000-PU 0032-17	16	- 22	- 4,5	PIRO-42000-PU 0044-1	22	- 32	- 7
PIRO-42000-PU 0032-18	16	- 22	- 6	PIRO-42000-PU 0044-11	22	- 30	- 5
PIRO-42000-PU 0032-19	16	- 22	- 7	PIRO-42000-PU 0044-12	22	- 38	- 10
PIRO-42000-PU 0032-2	16	- 26	- 6	PIRO-42000-PU 0044-13	22	- 32	- 10
PIRO-42000-PU 0032-6	16	- 22	- 3	PIRO-42000-PU 0044-14	22	- 32	- 5
PIRO-42000-PU 0032-7	16	- 29	- 6	PIRO-42000-PU 0044-15	22	- 30	- 10
PIRO-42000-PU 0032-8	16	- 26	- 5	PIRO-42000-PU 0044-17	22	- 46	- 12
PIRO-42000-PU 0032-9	16	- 22	- 4	PIRO-42000-PU 0044-18	22,4	- 30	- 5
PIRO-42000-PU 0034-1	17	- 32	- 10	PIRO-42000-PU 0044-4	22	- 34	- 6
PIRO-42000-PU 0034-2	17	- 25	- 4	PIRO-42000-PU 0044-6	22	- 42	- 10
PIRO-42000-PU 0036	18	- 28	- 8	PIRO-42000-PU 0044-7	22	- 34	- 10
PIRO-42000-PU 0036-1	18	- 30	- 6	PIRO-42000-PU 0044-8	22	- 32	- 6
PIRO-42000-PU 0036-10	18	- 28	- 6	PIRO-42000-PU 0044-9	22	- 40	- 10
PIRO-42000-PU 0036-11	18	- 24	- 8	PIRO-42000-PU 0048	24	- 34	- 5
PIRO-42000-PU 0036-12	18	- 26	- 4	PIRO-42000-PU 0048-1	24	- 32	- 4
PIRO-42000-PU 0036-13	18	- 26	- 6	PIRO-42000-PU 0048-2	24	- 40	- 8
PIRO-42000-PU 0036-2	18	- 30	- 7,5	PIRO-42000-PU 0048-4	24	- 36	- 6,3

## DTH-PIRO-42000-PU

## Kolben und Stangendichtung / Piston Rod Seal

Nummer:	d	D	b	Nummer:	d	D	b
PIRO-42000-PU 0050	25	- 40	- 10	PIRO-42000-PU 0060-8	30	- 38	- 5,5
PIRO-42000-PU 0050-11	25	- 33	- 4	PIRO-42000-PU 0060-9	30	- 40	- 6
PIRO-42000-PU 0050-12	25	- 38	- 7	PIRO-42000-PU 0060-11	30	- 38	- 10
PIRO-42000-PU 0050-14	25	- 38	- 10	PIRO-42000-PU 0060-15	30	- 40	- 8
PIRO-42000-PU 0050-15	25	- 50	- 12	PIRO-42000-PU 0060-17	30,16	- 38,1	- 3,97
PIRO-42000-PU 0050-16	25	- 32	- 4	PIRO-42000-PU 0060-18	30	- 37	- 6
PIRO-42000-PU 0050-17	25	- 33	- 7	PIRO-42000-PU 0060-20	30	- 45	- 12
PIRO-42000-PU 0050-18	25	- 40	- 11	PIRO-42000-PU 0060-21	30	- 38	- 8
PIRO-42000-PU 0050-19	25	- 35	- 6	PIRO-42000-PU 0064	32	- 47	- 10
PIRO-42000-PU 0050-23	25	- 35	- 10	PIRO-42000-PU 0064-1	32	- 40	- 8
PIRO-42000-PU 0050-26	25	- 36	- 6,9	PIRO-42000-PU 0064-10	32	- 52	- 10
PIRO-42000-PU 0050-27	25	- 38	- 9,5	PIRO-42000-PU 0064-3	32	- 42	- 6
PIRO-42000-PU 0050-2	25	- 33	- 5	PIRO-42000-PU 0064-4	32	- 45	- 10
PIRO-42000-PU 0050-3	25	- 35	- 5	PIRO-42000-PU 0064-5	32	- 50	- 12
PIRO-42000-PU 0050-4	25	- 35	- 7	PIRO-42000-PU 0064-6	32	- 40	- 4
PIRO-42000-PU 0050-5	25	- 35	- 8	PIRO-42000-PU 0064-7	32	- 40	- 5
PIRO-42000-PU 0050-6	25	- 37	- 7	PIRO-42000-PU 0064-8	32	- 44	- 6,35
PIRO-42000-PU 0050-7	25	- 38	- 9	PIRO-42000-PU 0064-9	32	- 40	- 5,7
PIRO-42000-PU 0050-8	25	- 45	- 10	PIRO-42000-PU 0064-11	32	- 44	- 6
PIRO-42000-PU 0050-9	25	- 32	- 7	PIRO-42000-PU 0064-12	32	- 45	- 8
PIRO-42000-PU 0052-1	26	- 42	- 8	PIRO-42000-PU 0064-13	32	- 48	- 10
PIRO-42000-PU 0052-2	26	- 35	- 8	PIRO-42000-PU 0064-14	32	- 40	- 10
PIRO-42000-PU 0052-3	26	- 38	- 10	PIRO-42000-PU 0064-15	32	- 50	- 10
PIRO-42000-PU 0054	27	- 35	- 4	PIRO-42000-PU 0066	33	- 43	- 6
PIRO-42000-PU 0054-1	27	- 38	- 6	PIRO-42000-PU 0070-2	35	- 45	- 10
PIRO-42000-PU 0054-3	27	- 35	- 6	PIRO-42000-PU 0070-5	35	- 43	- 6
PIRO-42000-PU 0056	28	- 43	- 10	PIRO-42000-PU 0070	35	- 50	- 10
PIRO-42000-PU 0056-1	28	- 40	- 10	PIRO-42000-PU 0070-3	35	- 55	- 10
PIRO-42000-PU 0056-2	28	- 48	- 10	PIRO-42000-PU 0070-4	35	- 55	- 12
PIRO-42000-PU 0056-3	28	- 48	- 12	PIRO-42000-PU 0070-6	35	- 52	- 12
PIRO-42000-PU 0056-4	28	- 35	- 6	PIRO-42000-PU 0070-7	35	- 45	- 6
PIRO-42000-PU 0056-5	28	- 36	- 6	PIRO-42000-PU 0070-8	35	- 47	- 6
PIRO-42000-PU 0056-6	28	- 36	- 5	PIRO-42000-PU 0070-9	35	- 50	- 7,5
PIRO-42000-PU 0056-7	28	- 35,5	- 5	PIRO-42000-PU 0070-11	35	- 48	- 8
PIRO-42000-PU 0056-8	28	- 38	- 10	PIRO-42000-PU 0070-12	35	- 45	- 8
PIRO-42000-PU 0056-9	28	- 44	- 8	PIRO-42000-PU 0072	36	- 51	- 10
PIRO-42000-PU 0056-10	28	- 38	- 5	PIRO-42000-PU 0072-1	36	- 51	- 7,1
PIRO-42000-PU 0056-11	28	- 32,8	- 3	PIRO-42000-PU 0072-2	36	- 50	- 8
PIRO-42000-PU 0056-12	28	- 48	- 8,5	PIRO-42000-PU 0072-3	36	- 46	- 7
PIRO-42000-PU 0056-13	28	- 36	- 4	PIRO-42000-PU 0072-4	36	- 48	- 6
PIRO-42000-PU 0056-14	28	- 40	- 6	PIRO-42000-PU 0072-5	36	- 46	- 6
PIRO-42000-PU 0056-15	28	- 35	- 5	PIRO-42000-PU 0072-7	36	- 46	- 5
PIRO-42000-PU 0060	30	- 45	- 10	PIRO-42000-PU 0076-1	38	- 55	- 10
PIRO-42000-PU 0060-1	30	- 40	- 10	PIRO-42000-PU 0076-2	38	- 58	- 10
PIRO-42000-PU 0060-10	30	- 37	- 8	PIRO-42000-PU 0076-3	38	- 50	- 6
PIRO-42000-PU 0060-2	30	- 42	- 10	PIRO-42000-PU 0076-4	38	- 50	- 10
PIRO-42000-PU 0030-3	30	- 50	- 10	PIRO-42000-PU 0076-7	38	- 45	- 6
PIRO-42000-PU 0060-4	30	- 50	- 12	PIRO-42000-PU 0076-8	38	- 50	- 9
PIRO-42000-PU 0060-6	30	- 40	- 7	PIRO-42000-PU 0076-9	38	- 48	- 7,5
PIRO-42000-PU 0060-7	30	- 38	- 4	PIRO-42000-PU 0078-1	39	- 58	- 10

**DTH-PIRO-42000-PU**
**Kolben und Stangendichtung / Piston Rod Seal**

Nummer:	d	D	b	Nummer:	d	D	b
PIRO-42000-PU 0080	40	- 55	- 10	PIRO-42000-PU 0096-4	48	- 68	- 10
PIRO-42000-PU 0080-1	40	- 50	- 6	PIRO-42000-PU 0096-5	48	- 60	- 6
PIRO-42000-PU 0080-10	40	- 50	- 5	PIRO-42000-PU 0096-6	48	- 63	- 10
PIRO-42000-PU 0080-11	40	- 50	- 8	PIRO-42000-PU 0100-1	50	- 60	- 10
PIRO-42000-PU 0080-12	40	- 65	- 10	PIRO-42000-PU 0100-11	50	- 60	- 8
PIRO-42000-PU 0080-13	40	- 56	- 8	PIRO-42000-PU 0100-12	50	- 58	- 8
PIRO-42000-PU 0080-14	40	- 48	- 11	PIRO-42000-PU 0100-13	50	- 60	- 6
PIRO-42000-PU 0080-15	40	- 55	- 7	PIRO-42000-PU 0100-14	50	- 60	- 12
PIRO-42000-PU 0080-16	40	- 52	- 6	PIRO-42000-PU 0100-15	50	- 60	- 7
PIRO-42000-PU 0080-17	40	- 70	- 12	PIRO-42000-PU 0100-16	50	- 57	- 10
PIRO-42000-PU 0080-18	40	- 55	- 12	PIRO-42000-PU 0100-18	50	- 63	- 6
PIRO-42000-PU 0080-19	40	- 65	- 12	PIRO-42000-PU 0100-19	50	- 62	- 6
PIRO-42000-PU 0080-2	40	- 50	- 10	PIRO-42000-PU 0100-20	50	- 60	- 5
PIRO-42000-PU 0080-3	40	- 52	- 12	PIRO-42000-PU 0100-24	50	- 63	- 12
PIRO-42000-PU 0080-4	40	- 60	- 10	PIRO-42000-PU 0100-25	50	- 63	- 7
PIRO-42000-PU 0080-5	40	- 60	- 12	PIRO-42000-PU 0100-26	50	- 63	- 10
PIRO-42000-PU 0080-6	40	- 50	- 9	PIRO-42000-PU 0100-2	50	- 62	- 9
PIRO-42000-PU 0080-7	40	- 50	- 7	PIRO-42000-PU 0100-3	50	- 63	- 8
PIRO-42000-PU 0080-8	40	- 56	- 10	PIRO-42000-PU 0100	50	- 65	- 10
PIRO-42000-PU 0084-1	42	- 50	- 5	PIRO-42000-PU 0100-4	50	- 63	- 9
PIRO-42000-PU 0084-2	42	- 62	- 12	PIRO-42000-PU 0100-5	50	- 65	- 12
PIRO-42000-PU 0084-3	42	- 57	- 8	PIRO-42000-PU 0100-6	50	- 68	- 12
PIRO-42000-PU 0084-5	42	- 50	- 8	PIRO-42000-PU 0100-7	50	- 70	- 8
PIRO-42000-PU 0084-6	42	- 51	- 11	PIRO-42000-PU 0100-8	50	- 70	- 10
PIRO-42000-PU 0084-7	42	- 52	- 10	PIRO-42000-PU 0100-9	50	- 70	- 12
PIRO-42000-PU 0084-8	42	- 50	- 6	PIRO-42000-PU 0104	52	- 62	- 12
PIRO-42000-PU 0086	43	- 63	- 10	PIRO-42000-PU 0104-1	52	- 62	- 6
PIRO-42000-PU 0088	44	- 57	- 9	PIRO-42000-PU 0106-2	53	- 63	- 12
PIRO-42000-PU 0090	45	- 60	- 10	PIRO-42000-PU 0106-3	53	- 63	- 7,5
PIRO-42000-PU 0090-1	45	- 55	- 10	PIRO-42000-PU 0106-5	53	- 63	- 6
PIRO-42000-PU 0090-10	45	- 63	- 10	PIRO-42000-PU 0110	55	- 75	- 12
PIRO-42000-PU 0090-11	45	- 58	- 10	PIRO-42000-PU 0110-1	55	- 70	- 10
PIRO-42000-PU 0090-13	45	- 55	- 8	PIRO-42000-PU 0110-3	55	- 70	- 12
PIRO-42000-PU 0090-14	45	- 55	- 6,5	PIRO-42000-PU 0110-4	55	- 80	- 15
PIRO-42000-PU 0090-2	45	- 57	- 6	PIRO-42000-PU 0110-5	55	- 65	- 12
PIRO-42000-PU 0090-3	45	- 63	- 12	PIRO-42000-PU 0110-6	55	- 80	- 12
PIRO-42000-PU 0090-4	45	- 65	- 10	PIRO-42000-PU 0110-7	55	- 65	- 5
PIRO-42000-PU 0090-5	45	- 65	- 12	PIRO-42000-PU 0110-8	55	- 70	- 7,5
PIRO-42000-PU 0090-6	45	- 70	- 12	PIRO-42000-PU 0110-9	55	- 65	- 6
PIRO-42000-PU 0090-7	45	- 55	- 6	PIRO-42000-PU 0112	56	- 76	- 12
PIRO-42000-PU 0090-8	45	- 53	- 7	PIRO-42000-PU 0112-2	56	- 80	- 15
PIRO-42000-PU 0090-9	45	- 53	- 8	PIRO-42000-PU 0112-3	56	- 71	- 10
PIRO-42000-PU 0092	46	- 70	- 12	PIRO-42000-PU 0112-4	56	- 66	- 5
PIRO-42000-PU 0092-1	46	- 58	- 6	PIRO-42000-PU 0112-5	56	- 70	- 12
PIRO-42000-PU 0094	47	- 65	- 12	PIRO-42000-PU 0112-6	56	- 66	- 6
PIRO-42000-PU 0094-3	47	- 63	- 8	PIRO-42000-PU 0116-1	58	- 70	- 6
PIRO-42000-PU 0096	48	- 63	- 12	PIRO-42000-PU 0116-3	58	- 78	- 15
PIRO-42000-PU 0096-1	48	- 60	- 9	PIRO-42000-PU 0120	60	- 80	- 12
PIRO-42000-PU 0096-2	48	- 68	- 12	PIRO-42000-PU 0120-1	60	- 80	- 10
PIRO-42000-PU 0096-3	48	- 58	- 6,5	PIRO-42000-PU 0120-2	60	- 70	- 12

**DTH-PIRO-42000-PU**

**Kolben und Stangendichtung / Piston Rod Seal**

Nummer:	d	D	b	Nummer:	d	D	b
PIRO-42000-PU 0120-4	60	- 75	- 12	PIRO-42000-PU 0164-4	82	- 102	- 10
PIRO-42000-PU 0120-5	60	- 70	- 13	PIRO-42000-PU 0166	83	- 103	- 14
PIRO-42000-PU 0120-6	60	- 70	- 6	PIRO-42000-PU 0170	85	- 105	- 12
PIRO-42000-PU 0120-7	60	- 70	- 7	PIRO-42000-PU 0170-2	85	- 100	- 12
PIRO-42000-PU 0120-9	60	- 75	- 10	PIRO-42000-PU 0170-6	85	- 110	- 12
PIRO-42000-PU 0122	61	- 80	- 12	PIRO-42000-PU 0170-8	85	- 100	- 9
PIRO-42000-PU 0122-1	61	- 71	- 6	PIRO-42000-PU 0170-9	85	- 100	- 25
PIRO-42000-PU 0126	63	- 83	- 12	PIRO-42000-PU 0170-10	85	- 102	- 9
PIRO-42000-PU 0126-2	63	- 72	- 6	PIRO-42000-PU 0180	90	- 110	- 12
PIRO-42000-PU 0126-3	63	- 75	- 10	PIRO-42000-PU 0180-10	90	- 100	- 6,8
PIRO-42000-PU 0130	65	- 85	- 12	PIRO-42000-PU 0180-11	90	- 120	- 15
PIRO-42000-PU 0130-1	65	- 80	- 12	PIRO-42000-PU 0180-12	90	- 105	- 9
PIRO-42000-PU 0130-2	65	- 90	- 8	PIRO-42000-PU 0180-14	90	- 115	- 15
PIRO-42000-PU 0130-3	65	- 90	- 13	PIRO-42000-PU 0180-2	90	- 100	- 8
PIRO-42000-PU 0130-4	65	- 90	- 15	PIRO-42000-PU 0180-3	90	- 110	- 10
PIRO-42000-PU 0130-5	65	- 75	- 10	PIRO-42000-PU 0180-4	90	- 110	- 15
PIRO-42000-PU 0130-6	65	- 75	- 6	PIRO-42000-PU 0180-6	90	- 115	- 12
PIRO-42000-PU 0130-8	65	- 75	- 12	PIRO-42000-PU 0180-7	90	- 105	- 12
PIRO-42000-PU 0130-9	65	- 80	- 10	PIRO-42000-PU 0190-1	95	- 110	- 10
PIRO-42000-PU 0130-10	65	- 75	- 7,3	PIRO-42000-PU 0190-2	95	- 115	- 12
PIRO-42000-PU 0122	66	- 77	- 6	PIRO-42000-PU 0190-3	95	- 115	- 15
PIRO-42000-PU 0140	70	- 90	- 12	PIRO-42000-PU 0190-4	95	- 120	- 12
PIRO-42000-PU 0140-1	70	- 80	- 12	PIRO-42000-PU 0190-6	95	- 110	- 9
PIRO-42000-PU 0140-10	70	- 80	- 8	PIRO-42000-PU 0190-7	95	- 110	- 12
PIRO-42000-PU 0140-4	70	- 85	- 12	PIRO-42000-PU 0192	96	- 105	- 11
PIRO-42000-PU 0140-5	70	- 80	- 5,4	PIRO-42000-PU 0200	100	- 125	- 15
PIRO-42000-PU 0140-7	70	- 90	- 10	PIRO-42000-PU 0200-1	100	- 120	- 12
PIRO-42000-PU 0140-9	70	- 80	- 6	PIRO-42000-PU 0200-2	100	- 120	- 15
PIRO-42000-PU 0142	71	- 80	- 6	PIRO-42000-PU 0200-3	100	- 130	- 18
PIRO-42000-PU 0144-1	72	- 90	- 10	PIRO-42000-PU 0200-5	100	- 110	- 5
PIRO-42000-PU 0150	75	- 95	- 12	PIRO-42000-PU 0200-6	100	- 130	- 15
PIRO-42000-PU 0150-1	75	- 85	- 12	PIRO-42000-PU 0200-7	100	- 110	- 8
PIRO-42000-PU 0150-2	75	- 90	- 12	PIRO-42000-PU 0200-9	100	- 115	- 9
PIRO-42000-PU 0150-3	75	- 90	- 10	PIRO-42000-PU 0210	105	- 130	- 15
PIRO-42000-PU 0150-6	75	- 85	- 7	PIRO-42000-PU 0210-1	105	- 120	- 8
PIRO-42000-PU 0150-8	75	- 85	- 6	PIRO-42000-PU 0210-2	105	- 130	- 18
PIRO-42000-PU 0150-9	75	- 85	- 10	PIRO-42000-PU 0210-3	105	- 120	- 15
PIRO-42000-PU 0152-1	76,2	- 101,6	- 16,67	PIRO-42000-PU 0214-2	107	- 130	- 15
PIRO-42000-PU 0160-1	80	- 95	- 8	PIRO-42000-PU 0216	108	- 127	- 10
PIRO-42000-PU 0160-2	80	- 95	- 9	PIRO-42000-PU 0220	110	- 135	- 18
PIRO-42000-PU 0160-3	80	- 95	- 12	PIRO-42000-PU 0220-1	110	- 140	- 18
PIRO-42000-PU 0160-4	80	- 90	- 5,4	PIRO-42000-PU 0220-1	110	- 125	- 12
PIRO-42000-PU 0160-10	80	- 90	- 6	PIRO-42000-PU 0220-3	110	- 130	- 10
PIRO-42000-PU 0160-11	80	- 90	- 5	PIRO-42000-PU 0220-4	110	- 120	- 8
PIRO-42000-PU 0160-9	80	- 90	- 10	PIRO-42000-PU 0220-5	110	- 130	- 15
PIRO-42000-PU 0164-1	82	- 92	- 10	PIRO-42000-PU 0224-1	112	- 125	- 9
PIRO-42000-PU 0170-3	85	- 95	- 9	PIRO-42000-PU 0230	115	- 140	- 18
PIRO-42000-PU 0160	80	- 100	- 12	PIRO-42000-PU 0230-2	115	- 125	- 8
PIRO-42000-PU 0160-5	80	- 100	- 10	PIRO-42000-PU 0230-3	115	- 135	- 15
PIRO-42000-PU 0160-6	80	- 105	- 15	PIRO-42000-PU 0230-5	115	- 130	- 10

## DTH-PIRO-42000-PU

## Kolben und Stangendichtung / Piston Rod Seal

Nummer:	d	D	b	Nummer:	d	D	b
PIRO-42000-PU 0230-6	115	- 125	- 15	PIRO-42000-PU 0330-1	165	- 195	- 20
PIRO-42000-PU 0240	120	- 145	- 18	PIRO-42000-PU 0330-2	165	- 180	- 9,5
PIRO-42000-PU 0240-1	120	- 150	- 15	PIRO-42000-PU 0336	168	- 180	- 14
PIRO-42000-PU 0240-2	120	- 132	- 10	PIRO-42000-PU 0340	170	- 200	- 15
PIRO-42000-PU 0240-3	120	- 150	- 18	PIRO-42000-PU 0340-1	170	- 200	- 22
PIRO-42000-PU 0240-4	120	- 140	- 10	PIRO-42000-PU 0340-2	170	- 190	- 15
PIRO-42000-PU 0240-6	120	- 130	- 7	PIRO-42000-PU 0340-3	170	- 183	- 13
PIRO-42000-PU 0240-7	120	- 140	- 15	PIRO-42000-PU 0350	175	- 215	- 20
PIRO-42000-PU 0240-8	120	- 135	- 15	PIRO-42000-PU 0350-1	175	- 200	- 15
PIRO-42000-PU 0240-9	120	- 135	- 12,3	PIRO-42000-PU 0350-2	175	- 195	- 15
PIRO-42000-PU 0250	125	- 155	- 18	PIRO-42000-PU 0360	180	- 210	- 22
PIRO-42000-PU 0250-1	125	- 150	- 18	PIRO-42000-PU 0360-1	180	- 200	- 15
PIRO-42000-PU 0250-3	125	- 140	- 11	PIRO-42000-PU 0360-2	180	- 205	- 15
PIRO-42000-PU 0250-4	125	- 145	- 15	PIRO-42000-PU 0360-3	180	- 200	- 12
PIRO-42000-PU 0250-6	125	- 145	- 10	PIRO-42000-PU 0370	185	- 195	- 12
PIRO-42000-PU 0250-7	125	- 140	- 9	PIRO-42000-PU 0370-1	185	- 200	- 9
PIRO-42000-PU 0250-8	125	- 140	- 8,5	PIRO-42000-PU 0380	190	- 220	- 25
PIRO-42000-PU 0254-1	127	- 151	- 16	PIRO-42000-PU 0380-1	190	- 210	- 15
PIRO-42000-PU 0260	130	- 150	- 15	PIRO-42000-PU 0380-3	190	- 225	- 30
PIRO-42000-PU 0260-1	130	- 160	- 18	PIRO-42000-PU 0380-4	190	- 220	- 15
PIRO-42000-PU 0260-2	130	- 140	- 8	PIRO-42000-PU 0380-5	190	- 210	- 12
PIRO-42000-PU 0260-4	130	- 152	- 13	PIRO-42000-PU 0380-6	190	- 210	- 13
PIRO-42000-PU 0260-5	130	- 160	- 12	PIRO-42000-PU 0390-1	195	- 215	- 13
PIRO-42000-PU 0264-1	132	- 145	- 8,5	PIRO-42000-PU 0400	200	- 230	- 22
PIRO-42000-PU 0270-1	135	- 150	- 15	PIRO-42000-PU 0400-2	200	- 240	- 20
PIRO-42000-PU 0270-2	135	- 165	- 15	PIRO-42000-PU 0400-3	200	- 235	- 20
PIRO-42000-PU 0272	136	- 150	- 9	PIRO-42000-PU 0400-4	200	- 220	- 15
PIRO-42000-PU 0280	140	- 170	- 18	PIRO-42000-PU 0400-5	200	- 230	- 18
PIRO-42000-PU 0280-1	140	- 160	- 15	PIRO-42000-PU 0400-7	200	- 220	- 12
PIRO-42000-PU 0280-2	140	- 160	- 8	PIRO-42000-PU 0400-8	200	- 225	- 15
PIRO-42000-PU 0280-3	140	- 160	- 10	PIRO-42000-PU 0420	210	- 230	- 15
PIRO-42000-PU 0280-4	140	- 165	- 18	PIRO-42000-PU 0420-1	210	- 240	- 18
PIRO-42000-PU 0280-6	140	- 155	- 9	PIRO-42000-PU 0430-1	215	- 245	- 18
PIRO-42000-PU 0290	145	- 160	- 8	PIRO-42000-PU 0440	220	- 250	- 20
PIRO-42000-PU 0290-1	145	- 170	- 18	PIRO-42000-PU 0440-2	220	- 250	- 15
PIRO-42000-PU 0290-2	145	- 175	- 18	PIRO-42000-PU 0440-3	220	- 250	- 18
PIRO-42000-PU 0290-3	145	- 165	- 15	PIRO-42000-PU 0450-1	225	- 250	- 15
PIRO-42000-PU 0290-4	145	- 160	- 9	PIRO-42000-PU 0450-2	225	- 242	- 11
PIRO-42000-PU 0300	150	- 180	- 18	PIRO-42000-PU 0450-4	225	- 250	- 18,2
PIRO-42000-PU 0300-3	150	- 170	- 15	PIRO-42000-PU 0460	230	- 250	- 15
PIRO-42000-PU 0300-4	150	- 180	- 15	PIRO-42000-PU 0460-1	230	- 260	- 18
PIRO-42000-PU 0300-6	150	- 165	- 9	PIRO-42000-PU 0460-2	230	- 250	- 12
PIRO-42000-PU 0310-1	155	- 175	- 15	PIRO-42000-PU 0470	235	- 255	- 12
PIRO-42000-PU 0310-2	155	- 180	- 15	PIRO-42000-PU 0480	240	- 260	- 16
PIRO-42000-PU 0320	160	- 190	- 22	PIRO-42000-PU 0480-1	240	- 270	- 18
PIRO-42000-PU 0320-1	160	- 180	- 15	PIRO-42000-PU 0480-3	240	- 265	- 18
PIRO-42000-PU 0320-3	160	- 195	- 17	PIRO-42000-PU 0490	245	- 275	- 18
PIRO-42000-PU 0320-5	160	- 170	- 5	PIRO-42000-PU 0500	250	- 270	- 15
PIRO-42000-PU 0320-8	160	- 175	- 12,5	PIRO-42000-PU 0500-1	250	- 275	- 19
PIRO-42000-PU 0330	165	- 185	- 15	PIRO-42000-PU 0500-2	250	- 280	- 22

**DTH-PIRO-42000-PU****Kolben und Stangendichtung / Piston Rod Seal**

Nummer:	d	D	b	Nummer:	d	D	b
PIRO-42000-PU 0500-3	250	- 280	- 18	PIRO-42000-PU 0640	320	- 350	- 15
PIRO-42000-PU 0520	260	- 290	- 18	PIRO-42000-PU 0640-2	320	- 350	- 19
PIRO-42000-PU 0520-1	260	- 290	- 15	PIRO-42000-PU 0650	325	- 360	- 20
PIRO-42000-PU 0540	270	- 300	- 18	PIRO-42000-PU 0660	330	- 360	- 20
PIRO-42000-PU 0540-3	270	- 300	- 19	PIRO-42000-PU 0680	340	- 360	- 15
PIRO-42000-PU 0560-1	280	- 300	- 15	PIRO-42000-PU 0720-1	360	- 380	- 16
PIRO-42000-PU 0580	290	- 310	- 12	PIRO-42000-PU 0720-2	360	- 390	- 20
PIRO-42000-PU 0600	300	- 330	- 17	PIRO-42000-PU 0750	375	- 395	- 12
PIRO-42000-PU 0300-1	300	- 320	- 15	PIRO-42000-PU 0800-1	400	- 425	- 19
PIRO-42000-PU 0600-2	300	- 330	- 19	PIRO-42000-PU 0860	430	- 450	- 15
PIRO-42000-PU 0620	310	- 330	- 15				

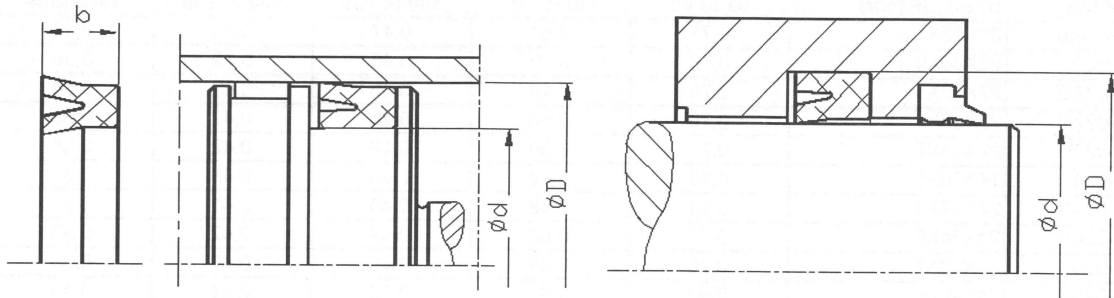

## DTH-PIRO-190000-NB

## Stangen und Kolbendichtung / Piston Rod Seal

Nummer:	d	D	b	Nummer:	d	D	b
PIRO-190000- 0006	3	- 7	- 5	PIRO-190000- 0040-3	20	- 30	- 8
PIRO-190000- 0008	4	- 10	- 4	PIRO-190000- 0040-5	20	- 35	- 10
PIRO-190000- 0010	5	- 12	- 5	PIRO-190000- 0040-6	20	- 32	- 7,5
PIRO-190000- 0012	6	- 12	- 4	PIRO-190000- 0044	22	- 30	- 6
PIRO-190000- 0012-1	6	- 15	- 5	PIRO-190000- 0044-2	22	- 32	- 5
PIRO-190000- 0012-3	6	- 16	- 6	PIRO-190000- 0044-3	22	- 28	- 5
PIRO-190000- 0014	7	- 15	- 5	PIRO-190000- 0044-1	22	- 35	- 7
PIRO-190000- 0016	8	- 14	- 4	PIRO-190000- 0048	24	- 30	- 5
PIRO-190000- 0016-1	8	- 14,2	- 3,5	PIRO-190000- 0048-1	24	- 32	- 4
PIRO-190000- 0016-2	8	- 16	- 3,5	PIRO-190000- 0048-2	24	- 34	- 5
PIRO-190000- 0016-3	8	- 16	- 4,2	PIRO-190000- 0050	25	- 33	- 7
PIRO-190000- 0016-4	8	- 12	- 4	PIRO-190000- 0050-1	25	- 40	- 6
PIRO-190000- 0020	10	- 14	- 2	PIRO-190000- 0054	27	- 36	- 6
PIRO-190000- 0020-1	10	- 16	- 4	PIRO-190000- 0056	28	- 38	- 5
PIRO-190000- 0020-3	10	- 18	- 5	PIRO-190000- 0056-2	28	- 52	- 10
PIRO-190000- 0020-4	10	- 22	- 6	PIRO-190000- 0058	29	- 35	- 6
PIRO-190000- 0020-5	10	- 19	- 3,5	PIRO-190000- 0060	30	- 40	- 9
PIRO-190000- 0020-6	10	- 20	- 3,5	PIRO-190000- 0060-1	30	- 45	- 10
PIRO-190000- 0020-7	10	- 23	- 4,5	PIRO-190000- 0060-2	30	- 55	- 12
PIRO-190000- 0024	12	- 18	- 4	PIRO-190000- 0064	32	- 42	- 8
PIRO-190000- 0024-1	12	- 20	- 5,5	PIRO-190000- 0064-1	32	- 40	- 7
PIRO-190000- 0024-3	12	- 22	- 5	PIRO-190000- 0064-2	32	- 48	- 8
PIRO-190000- 0024-4	12	- 24	- 6	PIRO-190000- 0064-3	32	- 40	- 4
PIRO-190000- 0028	14	- 20	- 4	PIRO-190000- 0066	33	- 42	- 7
PIRO-190000- 0028-1	14	- 20	- 4,8	PIRO-190000- 0070	35	- 45	- 5
PIRO-190000- 0028-2	14	- 25	- 3,5	PIRO-190000- 0070-1	35	- 45	- 6
PIRO-190000- 0030	15	- 22	- 4	PIRO-190000- 0070-2	35	- 42	- 5,3
PIRO-190000- 0030-1	15	- 24	- 7	PIRO-190000- 0080	40	- 50	- 5
PIRO-190000- 0030-2	15	- 25	- 6	PIRO-190000- 0080-1	40	- 60	- 10
PIRO-190000- 0032	16	- 22	- 4	PIRO-190000- 0080-2	40	- 48	- 8
PIRO-190000- 0032-1	16	- 22	- 6	PIRO-190000- 0092	46	- 70	- 12
PIRO-190000- 0032-2	16	- 25	- 5	PIRO-190000- 0096	48	- 60	- 6
PIRO-190000- 0032-3	16	- 26	- 5	PIRO-190000- 0096-1	48	- 60	- 7
PIRO-190000- 0036-1	18	- 24	- 4	PIRO-190000- 0100	50	- 80	- 15
PIRO-190000- 0036-2	18	- 25	- 4	PIRO-190000- 0100-1	50	- 75	- 12
PIRO-190000- 0036	18	- 26	- 4	PIRO-190000- 0110	55	- 70	- 10
PIRO-190000- 0040	20	- 28	- 4	PIRO-190000- 0116	58	- 70	- 6
PIRO-190000- 0040-1	20	- 28	- 8	PIRO-190000- 0120	60	- 100	- 20

**DTH-PIRO-190000-NB****Stangen und Kolbendichtung / Piston Rod Seal**

Nummer:	d	D	b	Nummer:	d	D	b
PIRO-190000- 0122	61	- 73	- 6	PIRO-190000- 0150	75	- 100	- 12
PIRO-190000- 0124	62	- 86	- 12	PIRO-190000- 0160	80	- 100	- 10
PIRO-190000- 0128	64	- 80	- 8	PIRO-190000- 0210P	130	- 150	- 10
PIRO-190000- 0144	72	- 84	- 8	PIRO-190000- 0212P	135	- 150	- 10
PIRO-190000- 0144-1	72	- 84	- 6	PIRO-190000- 0214P	220	- 250	- 15
PIRO-190000- 0144-2	72	- 82	- 5	PIRO-190000- 0220-2P	230	- 270	- 20
PIRO-190000- 0150-1	75	- 90	- 7,5	PIRO-190000- 0220-3P	290	- 330	- 20



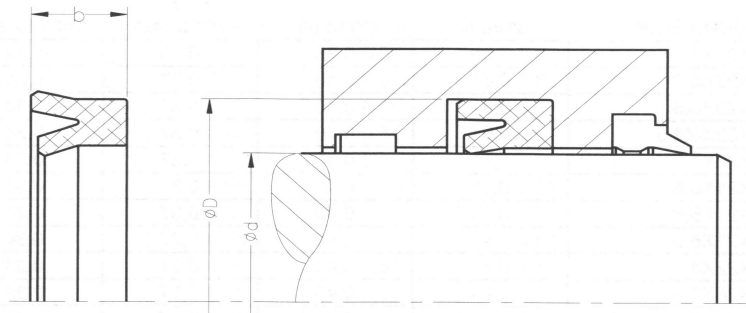

## DTH-RO-44000-NB

## Stangendichtung / Rod Seal

Nummer:	d	D	b	Nummer:	d	D	b
RO-44000-NB 0004	2,5	- 5	- 1,7	RO-44000-NB 0024-6	12	- 16	- 3
RO-44000-NB 0004-1	2	- 4,5	- 1,7	RO-44000-NB 0026	13	- 17,5	- 3,3
RO-44000-NB 0004-2	2	- 5,5	- 2,6	RO-44000-NB 0026-1	13	- 23	- 8
RO-44000-NB 0006	3	- 7	- 3	RO-44000-NB 0028	14	- 22	- 5,5
RO-44000-NB 0006-1	3	- 6,5	- 3	RO-44000-NB 0030	15	- 23	- 6
RO-44000-NB 0006-2	3	- 6	- 2,5	RO-44000-NB 0032	16	- 20,5	- 5
RO-44000-NB 0008-1	4	- 8	- 3	RO-44000-NB 0032-1	16	- 22,5	- 4,5
RO-44000-NB 0008-2	4	- 12	- 4,5	RO-44000-NB 0032-2	16	- 26	- 7
RO-44000-NB 0008-3	4	- 9	- 3,5	RO-44000-NB 0032-3	16	- 24	- 5,5
RO-44000-NB 0008-5	4	- 10	- 4,2	RO-44000-NB 0032-4	16	- 24	- 6,5
RO-44000-NB 0008-6	4	- 12	- 6	RO-44000-NB 0032-5	16	- 23	- 5,5
RO-44000-NB 0010	5	- 12	- 4,5	RO-44000-NB 0032-6	16	- 22	- 4
RO-44000-NB 0010-1	5	- 9	- 3	RO-44000-NB 0032-7	16	- 26	- 7,5
RO-44000-NB 0012	6	- 13	- 5,5	RO-44000-NB 0032-8	16	- 26	- 5
RO-44000-NB 0012-1	6	- 10	- 3	RO-44000-NB 0032-9	16	- 24	- 5
RO-44000-NB 0012-3	6	- 12	- 4	RO-44000-NB 0032-10	16	- 22	- 5
RO-44000-NB 0012-5	6	- 14	- 5,8	RO-44000-NB 0036	18	- 24	- 5
RO-44000-NB 0016	8	- 14	- 4	RO-44000-NB 0036-1	18	- 25	- 5
RO-44000-NB 0016-1	8	- 16	- 6	RO-44000-NB 0036-2	18	- 25	- 5,5
RO-44000-NB 0016-2	8	- 14	- 4,5	RO-44000-NB 0036-3	18	- 28	- 7
RO-44000-NB 0016-3	8	- 13,2	- 3,1	RO-44000-NB 0036-4	18	- 22	- 3
RO-44000-NB 0016-4	8	- 16	- 5,5	RO-44000-NB 0036-5	18	- 25	- 4,5
RO-44000-NB 0016-5	8	- 13	- 3	RO-44000-NB 0036-6	18	- 26	- 4,5
RO-44000-NB 0018-1	9	- 15	- 9	RO-44000-NB 0040	20	- 30	- 6
RO-44000-NB 0020	10	- 18	- 5,5	RO-44000-NB 0040-10	20	- 32	- 6
RO-44000-NB 0020-1	10	- 16	- 4,5	RO-44000-NB 0040-11	20	- 32	- 7
RO-44000-NB 0020-1	10	- 14	- 4	RO-44000-NB 0040-2	20	- 30	- 10
RO-44000-NB 0020-3	10	- 16	- 6	RO-44000-NB 0040-3	20	- 32	- 7,5
RO-44000-NB 0020-4	10	- 14	- 2	RO-44000-NB 0040-4	20	- 28	- 5,5
RO-44000-NB 0020-5	10	- 20	- 6,5	RO-44000-NB 0040-6	20	- 26	- 3,5
RO-44000-NB 0020-6	10	- 20	- 4,5	RO-44000-NB 0040-7	20	- 30	- 8
RO-44000-NB 0020-7	10	- 13,6	- 2,3	RO-44000-NB 0040-8	20	- 30	- 7
RO-44000-NB 0024	12	- 22	- 8	RO-44000-NB 0040-9	20	- 30	- 7,5
RO-44000-NB 0024-1	12	- 20	- 5,5	RO-44000-NB 0044-1	22	- 30	- 8
RO-44000-NB 0024-2	12	- 17	- 3,7	RO-44000-NB 0044-2	22	- 30	- 7
RO-44000-NB 0024-3	12	- 22	- 5	RO-44000-NB 0044-3	22	- 30	- 5,5
RO-44000-NB 0024-4	12	- 18	- 4,5	RO-44000-NB 0044-6	22	- 29	- 5
RO-44000-NB 0024-5	12	- 22	- 7,5	RO-44000-NB 0044	22	- 32	- 6

## DTH-RO-44000-NB

## Stangendichtung / Rod Seal

Nummer:	d	D	b	Nummer:	d	D	b
RO-44000-NB 0046	23	- 31	- 5,5	RO-44000-NB 0080-3	40	- 50	- 8
RO-44000-NB 0050	25	- 35	- 6	RO-44000-NB 0080-4	40	- 55	- 10
RO-44000-NB 0050-1	25	- 35	- 8	RO-44000-NB 0080-6	40	- 48	- 8
RO-44000-NB 0050-10	25	- 33	- 5,5	RO-44000-NB 0080-7	40	- 48	- 5,4
RO-44000-NB 0050-11	25	- 30	- 4	RO-44000-NB 0080-9	40	- 48	- 5,8
RO-44000-NB 0050-12	25,4	- 38,1	- 6,35	RO-44000-NB 0084	42	- 52	- 7
RO-44000-NB 0050-3	25	- 35	- 7	RO-44000-NB 0090	45	- 55	- 10
RO-44000-NB 0050-4	25	- 33	- 10	RO-44000-NB 0090-2	45	- 61	- 12
RO-44000-NB 0050-5	25	- 37	- 6	RO-44000-NB 0090-3	45	- 55	- 7
RO-44000-NB 0050-6	25	- 40	- 10	RO-44000-NB 0090-4	45	- 60	- 7
RO-44000-NB 0050-7	25	- 32	- 6	RO-44000-NB 0090-5	45	- 65	- 10
RO-44000-NB 0050-8	25	- 35	- 10	RO-44000-NB 0090-7	45	- 60	- 9
RO-44000-NB 0050-9	25	- 35	- 7,5	RO-44000-NB 0100	50	- 60	- 10
RO-44000-NB 0056	28	- 38	- 6	RO-44000-NB 0100-4	50	- 60	- 7
RO-44000-NB 0056-2	28	- 38	- 10	RO-44000-NB 0100-5	50	- 60	- 6
RO-44000-NB 0056-4	28	- 36	- 5,5	RO-44000-NB 0100-6	50	- 62	- 10
RO-44000-NB 0056-6	28	- 38	- 7	RO-44000-NB 0100-9	50	- 58	- 8
RO-44000-NB 0056-7	28	- 36	- 5	RO-44000-NB 0104	52	- 62	- 10
RO-44000-NB 0056-8	28	- 38	- 8	RO-44000-NB 0104-1	52	- 69	- 9
RO-44000-NB 0056-9	28	- 36	- 5,7	RO-44000-NB 0108	54	- 64	- 7
RO-44000-NB 0056-10	28	- 35	- 7	RO-44000-NB 0110	55	- 65	- 10
RO-44000-NB 0056-11	28	- 36	- 8	RO-44000-NB 0110-1	55	- 70	- 10
RO-44000-NB 0056-13	28,58	- 41,28	- 7,93	RO-44000-NB 0110-2	55	- 64	- 7,3
RO-44000-NB 0060	30	- 40	- 8	RO-44000-NB 0110-3	55	- 65	- 7,3
RO-44000-NB 0060-1	30	- 40	- 6	RO-44000-NB 0112	56	- 68	- 8,5
RO-44000-NB 0060-2	30	- 40	- 7	RO-44000-NB 0112-2	56	- 66	- 10
RO-44000-NB 0060-3	30	- 38	- 6,3	RO-44000-NB 0112-4	56	- 68	- 7,5
RO-44000-NB 0060-4	30	- 38	- 6	RO-44000-NB 0120	60	- 70	- 10
RO-44000-NB 0060-5	30	- 38	- 5,5	RO-44000-NB 0120-3	60	- 70	- 8,5
RO-44000-NB 0060-7	30	- 42	- 8,5	RO-44000-NB 0120-1	60	- 74	- 8
RO-44000-NB 0060-8	30	- 38	- 8	RO-44000-NB 0120-2	60	- 75	- 12
RO-44000-NB 0064	32	- 42	- 7	RO-44000-NB 0120-4	60	- 72	- 8,5
RO-44000-NB 0064-1	32	- 48	- 8	RO-44000-NB 0120-5	60	- 70	- 12
RO-44000-NB 0066	33	- 40	- 5,5	RO-44000-NB 0126	63	- 73	- 6,5
RO-44000-NB 0068	34	- 44	- 7	RO-44000-NB 0126-2	63	- 75	- 8,5
RO-44000-NB 0070	35	- 45	- 8	RO-44000-NB 0130	65	- 75	- 10
RO-44000-NB 0070-1	35	- 45	- 7	RO-44000-NB 0130-1	65	- 77	- 8,7
RO-44000-NB 0070-3	35	- 50	- 8	RO-44000-NB 0136	68	- 80	- 8,5
RO-44000-NB 0070-4	35	- 45	- 6	RO-44000-NB 0140	70	- 80	- 12
RO-44000-NB 0070-5	35	- 45	- 10	RO-44000-NB 0140-1	70	- 85	- 10
RO-44000-NB 0070-6	35	- 43	- 6	RO-44000-NB 0140-4	70	- 82	- 8,5
RO-44000-NB 0070-7	35	- 43	- 8	RO-44000-NB 0150	75	- 85	- 12
RO-44000-NB 0072	36	- 46	- 8	RO-44000-NB 0150-2	75	- 90	- 10
RO-44000-NB 0072-2	36	- 46	- 10	RO-44000-NB 0160	80	- 90	- 12
RO-44000-NB 0072-3	36	- 46	- 7	RO-44000-NB 0160-1	80	- 92	- 9,5
RO-44000-NB 0072-4	36	- 44	- 5	RO-44000-NB 0160-2	80	- 92	- 8,5
RO-44000-NB 0072-5	36	- 51	- 10	RO-44000-NB 0160-3	80	92	7,5
RO-44000-NB 0078	39,69	- 55,96	- 9,52	RO-44000-NB 0170	85	95	12
RO-44000-NB 0080	40	- 50	- 10	RO-44000-NB 0170-1	85	95	7
RO-44000-NB 0080-2	40	- 50	- 7	RO-44000-NB 0180	90	100	12

**DTH-RO-44000-NB****Stangendichtung / Rod Seal**

Nummer:	d	D	b	Nummer:	d	D	b
RO-44000-NB 0180-1	90	- 102	- 8,5	RO-44000-NB 0310	155	- 165	- 12
RO-44000-NB 0190	95	- 105	- 12	RO-44000-NB 0320	160	- 170	- 12
RO-44000-NB 0200	100	- 110	- 14	RO-44000-NB 0320-3	160	- 184	- 15
RO-44000-NB 0200-3	100	- 115	- 10	RO-44000-NB 0370	185	- 195	- 12
RO-44000-NB 0210	105	- 120	- 12	RO-44000-NB 0370-1	185	- 215	- 20
RO-44000-NB 0210-2	105	- 120	- 10	RO-44000-NB 0400	200	- 235	- 21
RO-44000-NB 0220	110	- 130	- 14	RO-44000-NB 0420	210	- 240	- 28
RO-44000-NB 0230	115	- 125	- 12	RO-44000-NB 0430	215	- 225	- 12
RO-44000-NB 0240	120	- 135	- 9,5	RO-44000-NB 0440-1	220	- 250	- 20
RO-44000-NB 0250-2	125	- 145	- 14	RO-44000-NB 0480	240	- 250	- 12
RO-44000-NB 0264	132	- 142	- 6	RO-44000-NB 0480-1	240	- 260	- 15
RO-44000-NB 0270	135	- 145	- 12	RO-44000-NB 0490	245	- 290	- 25
RO-44000-NB 0280-1	140	- 160	- 14				

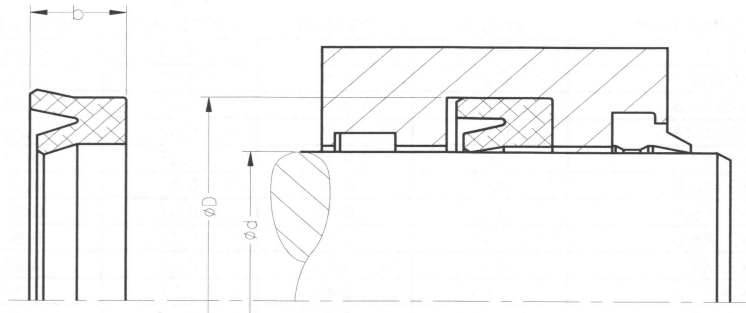

## DTH-RO-44000-PU

## Stangendichtung / Rod Seal

Nummer:	d	D	b	Nummer:	d	D	b
RO-44000-PU 0008-6	4	- 12	- 6	RO-44000-PU 0040-2	20	- 30	- 10
RO-44000-PU 0010-1	5	- 9	- 3	RO-44000-PU 0040-3	20	- 32	- 7,5
RO-44000-PU 0012-1	6	- 10	- 3	RO-44000-PU 0040-4	20	- 28	- 5,5
RO-44000-PU 0012-3	6	- 12	- 4	RO-44000-PU 0040-6	20	- 26	- 3,5
RO-44000-PU 0012-4	6	- 13	- 5	RO-44000-PU 0040-7	20	- 30	- 8
RO-44000-PU 0012-5	6	- 14	- 5,8	RO-44000-PU 0040-8	20	- 30	- 7
RO-44000-PU 0016	8	- 14	- 4	RO-44000-PU 0040-9	20	- 30	- 7,5
RO-44000-PU 0018-3	9	- 14	- 2,25	RO-44000-PU 0044	22	- 32	- 6
RO-44000-PU 0020	10	- 18	- 5,5	RO-44000-PU 0044-1	22	- 30	- 8
RO-44000-PU 0020-1	10	- 16	- 4,5	RO-44000-PU 0044-2	22	- 30	- 7
RO-44000-PU 0020-2	10	- 14	- 4	RO-44000-PU 0044-3	22	- 30	- 5,5
RO-44000-PU 0020-6	10	- 20	- 4,5	RO-44000-PU 0044-6	22	- 29	- 5
RO-44000-PU 0024	12	- 22	- 8	RO-44000-PU 0046	23	- 31	- 5,5
RO-44000-PU 0024-1	12	- 20	- 5,5	RO-44000-PU 0050	25	- 35	- 6
RO-44000-PU 0024-2	12	- 17	- 3,7	RO-44000-PU 0050-1	25	- 35	- 8
RO-44000-PU 0024-3	12	- 22	- 5	RO-44000-PU 0050-10	25	- 33	- 5,5
RO-44000-PU 0024-5	12	- 22	- 7,5	RO-44000-PU 0050-4	25	- 33	- 10
RO-44000-PU 0024-6	12	- 16	- 3	RO-44000-PU 0050-5	25	- 37	- 6
RO-44000-PU 0024-7	12	- 18,5	- 4,5	RO-44000-PU 0050-7	25	- 32	- 6
RO-44000-PU 0026	13	- 17,5	- 3,3	RO-44000-PU 0050-8	25	- 35	- 10
RO-44000-PU 0026-1	13	- 23	- 8	RO-44000-PU 0050-9	25	- 35	- 7,5
RO-44000-PU 0028	14	- 22	- 5,5	RO-44000-PU 0050-6	25	- 40	- 10
RO-44000-PU 0030	15	- 23	- 6	RO-44000-PU 0056	28	- 38	- 6
RO-44000-PU 0032	16	- 20,5	- 5	RO-44000-PU 0056-2	28	- 38	- 10
RO-44000-PU 0032-2	16	- 26	- 7	RO-44000-PU 0056-4	28	- 36	- 5,5
RO-44000-PU 0032-3	16	- 24	- 5,5	RO-44000-PU 0056-6	28	- 38	- 7
RO-44000-PU 0032-4	16	- 24	- 6,5	RO-44000-PU 0056-8	28	- 38	- 8
RO-44000-PU 0032-5	16	- 23	- 5,5	RO-44000-PU 0056-9	28	- 36	- 5,7
RO-44000-PU 0032-8	16	- 26	- 5	RO-44000-PU 0056-10	28	- 35	- 7
RO-44000-PU 0032-9	16	- 24	- 5	RO-44000-PU 0056-11	28	- 36	- 8
RO-44000-PU 0032-10	16	- 22	- 5	RO-44000-PU 0060	30	- 40	- 8
RO-44000-PU 0036	18	- 24	- 5	RO-44000-PU 0060-1	30	- 40	- 6
RO-44000-PU 0036-1	18	- 25	- 5	RO-44000-PU 0060-2	30	- 40	- 7
RO-44000-PU 0036-2	18	- 25	- 5,5	RO-44000-PU 0060-3	30	- 38	- 6,3
RO-44000-PU 0036-3	18	- 28	- 7	RO-44000-PU 0060-4	30	- 38	- 6
RO-44000-PU 0036-6	18	- 26	- 4,5	RO-44000-PU 0060-5	30	- 38	- 5,5
RO-44000-PU 0040	20	- 30	- 6	RO-44000-PU 0060-6	30	- 38	- 5,7
RO-44000-PU 0040-10	20	- 32	- 6	RO-44000-PU 0060-7	30	- 42	- 8,5

**DTH-RO-44000-PU****Stangendichtung / Rod Seal**

Nummer:	d	D	b	Nummer:	d	D	b
RO-44000-PU 0060-8	30	- 38	- 8	RO-44000-PU 0126-3	63	- 73	- 12
RO-44000-PU 0064	32	- 42	- 7	RO-44000-PU 0126-4	63	- 78	- 10
RO-44000-PU 0064-1	32	- 48	- 8	RO-44000-PU 0130	65	- 75	- 10
RO-44000-PU 0066	33	- 40	- 5,5	RO-44000-PU 0140	70	- 80	- 12
RO-44000-PU 0068	34	- 44	- 7	RO-44000-PU 0140-1	70	- 85	- 10
RO-44000-PU 0070	35	- 45	- 8	RO-44000-PU 0140-5	70	- 90	- 13,5
RO-44000-PU 0070-1	35	- 45	- 7	RO-44000-PU 0140-6	70	- 85	- 11,5
RO-44000-PU 0070-3	35	- 50	- 8	RO-44000-PU 0150	75	- 85	- 12
RO-44000-PU 0070-4	35	- 45	- 6	RO-44000-PU 0150-1	75	- 95	- 12
RO-44000-PU 0070-5	35	- 45	- 10	RO-44000-PU 0160	80	- 90	- 12
RO-44000-PU 0070-6	35	- 43	- 6	RO-44000-PU 0160-5	80	- 95	- 10
RO-44000-PU 0070-7	35	- 43	- 8	RO-44000-PU 0170	85	- 95	- 12
RO-44000-PU 0072	36	- 46	- 8	RO-44000-PU 0170-1	85	- 95	- 7
RO-44000-PU 0072-2	36	- 46	- 10	RO-44000-PU 0160-4	80	- 100	- 13,5
RO-44000-PU 0072-4	36	- 44	- 5	RO-44000-PU 0180	90	- 100	- 12
RO-44000-PU 0072-5	36	- 51	- 10	RO-44000-PU 0180-2	90	- 110	- 11,5
RO-44000-PU 0080	40	- 50	- 10	RO-44000-PU 0180-3	90	- 105	- 11,4
RO-44000-PU 0080-2	40	- 50	- 7	RO-44000-PU 0190	95	- 105	- 12
RO-44000-PU 0080-3	40	- 50	- 8	RO-44000-PU 0190-1	95	- 110	- 12
RO-44000-PU 0080-6	40	- 48	- 8	RO-44000-PU 0196	98	- 118	- 9
RO-44000-PU 0080-7	40	- 48	- 5,4	RO-44000-PU 0200	100	- 110	- 14
RO-44000-PU 0080-9	40	- 48	- 5,8	RO-44000-PU 0200-1	100	- 115	- 9
RO-44000-PU 0084	42	- 52	- 7	RO-44000-PU 0200-2	100	- 115	- 12
RO-44000-PU 0090	45	- 55	- 10	RO-44000-PU 0200-4	100	- 120	- 13,5
RO-44000-PU 0090-2	45	- 61	- 12	RO-44000-PU 0200-5	100	- 120	- 14,5
RO-44000-PU 0090-3	45	- 55	- 7	RO-44000-PU 0210	105	- 120	- 12
RO-44000-PU 0090-5	45	- 65	- 10	RO-44000-PU 0210-1	105	- 125	- 12
RO-44000-PU 0090-7	45	- 60	- 9	RO-44000-PU 0212	106	- 120	- 10
RO-44000-PU 0100	50	- 60	- 10	RO-44000-PU 0220-1	110	- 130	- 11,5
RO-44000-PU 0100-3	50	- 65	- 10	RO-44000-PU 0230	115	- 125	- 12
RO-44000-PU 0100-4	50	- 60	- 7	RO-44000-PU 0236	118	- 133	- 9
RO-44000-PU 0100-5	50	- 60	- 6	RO-44000-PU 0240	120	- 135	- 9,5
RO-44000-PU 0100-7	50	- 62	- 8	RO-44000-PU 0240-2	120	- 140	- 14,6
RO-44000-PU 0100-9	50	- 58	- 8	RO-44000-PU 0240-3	120	- 140	- 11,5
RO-44000-PU 0104	52	- 62	- 10	RO-44000-PU 0240-4	120	- 135	- 14,5
RO-44000-PU 0104-1	52	- 69	- 9	RO-44000-PU 0250	125	- 135	- 13,5
RO-44000-PU 0110	55	- 65	- 10	RO-44000-PU 0250-1	125	- 145	- 12
RO-44000-PU 0110-2	55	- 64	- 7,3	RO-44000-PU 0260	130	- 140	- 13,5
RO-44000-PU 0110-3	55	- 65	- 7,3	RO-44000-PU 0260-1	130	- 150	- 15
RO-44000-PU 0112	56	- 68	- 8,5	RO-44000-PU 0264	132	- 142	- 6
RO-44000-PU 0112-2	56	- 66	- 10	RO-44000-PU 0270	135	- 145	- 12
RO-44000-PU 0112-4	56	- 68	- 7,5	RO-44000-PU 0300	150	- 160	- 13,5
RO-44000-PU 0120	60	- 70	- 10	RO-44000-PU 0300-1	150	- 170	- 15
RO-44000-PU 0120-1	60	- 74	- 8	RO-44000-PU 0300-2	150	- 165	- 9
RO-44000-PU 0120-2	60	- 75	- 12	RO-44000-PU 0300-3	150	- 170	- 13,5
RO-44000-PU 0120-3	60	- 70	- 8,5	RO-44000-PU 0310	155	- 165	- 12
RO-44000-PU 0120-4	60	- 72	- 8,5	RO-44000-PU 0320	160	170	12
RO-44000-PU 0120-5	60	- 70	- 12	RO-44000-PU 0320-2	160	180	15
RO-44000-PU 0126	63	- 73	- 6,5	RO-44000-PU 0320-4	160	180	12
RO-44000-PU 0126-2	63	- 75	- 8,5	RO-44000-PU 0330	165	180	11

**DTH-RO-44000-PU****Stangendichtung / Rod Seal**

Nummer:	d	D	b	Nummer:	d	D	b
RO-44000-PU 0340	170	- 180	- 14,5	RO-44000-PU 0440	220	- 240	- 15
RO-44000-PU 0340-1	170	- 190	- 15	RO-44000-PU 0440-2	220	- 250	- 22,7
RO-44000-PU 0360-1	180	- 200	- 12	RO-44000-PU 0440-3	220	- 245	- 19
RO-44000-PU 0360-2	180	- 195	- 12,5	RO-44000-PU 0480	240	- 250	- 12
RO-44000-PU 0360-3	180	- 190	- 11	RO-44000-PU 0480-1	240	- 260	- 15
RO-44000-PU 0370	185	- 195	- 12	RO-44000-PU 0480-2	240	- 270	- 18
RO-44000-PU 0400-1	200	- 225	- 15	RO-44000-PU 0500	250	- 270	- 15
RO-44000-PU 0400-2	200	- 220	- 15	RO-44000-PU 0500-1	250	- 270	- 12
RO-44000-PU 0420	210	- 240	- 28	RO-44000-PU 0504	252	- 273	- 10
RO-44000-PU 0424	212	- 224	- 10	RO-44000-PU 0560	280	- 300	- 15
RO-44000-PU 0430	215	- 225	- 12	RO-44000-PU 0660	330	- 360	- 22,8

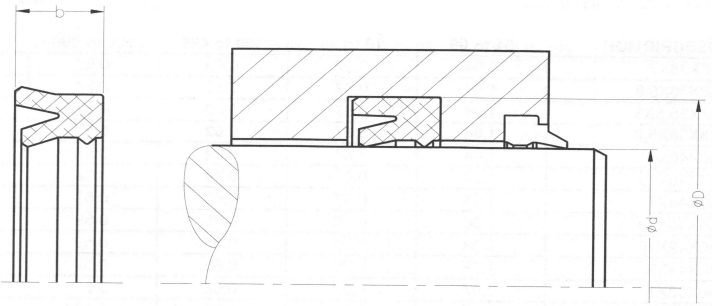

## DTH-RO-66000-PU

## Stangendichtung / Rod Seal

Nummer:	d	D	b	Nummer:	d	D	b
RO-66000-0012	6	- 9	- 3,5	RO-66000-0056-1	28	- 38	- 7
RO-66000-0024	12	- 24	- 8	RO-66000-0056-2	28	- 36	- 5,8
RO-66000-0024-1	12	- 22	- 7	RO-66000-0056-3	28	- 35,5	- 5
RO-66000-0028	14	- 24	- 7,2	RO-66000-0056-4	28	- 38	- 5,8
RO-66000-0032	16	- 22	- 4,5	RO-66000-0060	30	- 40	- 8
RO-66000-0032-1	16	- 26	- 8	RO-66000-0060-1	30	- 45	- 10
RO-66000-0034	17	- 23	- 4	RO-66000-0060-2	30	- 40	- 7
RO-66000-0036	18	- 24	- 4,9	RO-66000-0060-3	30	- 40	- 10
RO-66000-0036-1	18	- 26	- 8	RO-66000-0060-4	30	- 42	- 10
RO-66000-0036-2	18	- 26	- 5	RO-66000-0060-5	30	- 43	- 9
RO-66000-0036-3	18	- 24	- 4,2	RO-66000-0060-6	30	- 38	- 7
RO-66000-0040	20	- 30	- 6	RO-66000-0060-7	30	- 38	- 6
RO-66000-0040-1	20	- 30	- 8	RO-66000-0060-8	30	- 40	- 6
RO-66000-0040-2	20	- 28	- 6	RO-66000-0064	32	- 40	- 6
RO-66000-0040-3	20	- 30	- 10	RO-66000-0064-1	32	- 40	- 7
RO-66000-0040-4	20	- 26	- 5,5	RO-66000-0064-2	32	- 42	- 10
RO-66000-0040-5	20	- 26	- 5	RO-66000-0064-3	32	- 42	- 7,3
RO-66000-0040-6	20	- 28	- 8	RO-66000-0064-4	32	- 40	- 8
RO-66000-0040-7	20	- 28	- 5	RO-66000-0064-5	32	- 42	- 6
RO-66000-0044	22	- 30	- 7	RO-66000-0070	35	- 45	- 8
RO-66000-0044-1	22	- 32	- 6	RO-66000-0070-1	35	- 50	- 10
RO-66000-0044-2	22	- 32	- 8	RO-66000-0070-2	35	- 43	- 5,7
RO-66000-0044-3	22	- 30	- 8	RO-66000-0070-3	35	- 45	- 10
RO-66000-0044-4	22	- 32	- 7	RO-66000-0070-4	35	- 43	- 7
RO-66000-0044-5	22,4	- 30	- 5	RO-66000-0070-5	35	- 43	- 6
RO-66000-0050	25	- 35	- 6	RO-66000-0070-6	35	- 45	- 6
RO-66000-0050-1	25	- 40	- 10	RO-66000-0070-7	35	- 51	- 10
RO-66000-0050-2	25	- 33	- 6	RO-66000-0070-8	35	- 45	- 7
RO-66000-0050-3	25	- 35	- 7	RO-66000-0072	36	- 46	- 8
RO-66000-0050-4	25	- 33	- 8	RO-66000-0072-1	36	- 51	- 10
RO-66000-0050-5	25	- 33	- 6,8	RO-66000-0072-2	36	- 52	- 10
RO-66000-0050-6	25	- 33	- 7,3	RO-66000-0072-3	36	- 46	- 7,3
RO-66000-0050-7	25	- 33	- 5,5	RO-66000-0072-4	36	- 44	- 6
RO-66000-0050-9	25	- 33	- 6,5	RO-66000-0072-5	36	- 46	- 10
RO-66000-0050-10	25	- 35	- 8	RO-66000-0074	37	- 47	- 8
RO-66000-0050-11	25	- 35	- 10	RO-66000-0074-1	37	- 47	- 10
RO-66000-0050-12	25	- 33	- 10	RO-66000-0076	38	- 48	- 9
RO-66000-0050-13	25	- 33	- 5	RO-66000-0076-1	38	- 50	- 6
RO-66000-0056	28	- 38	- 10	RO-66000-0080	40	- 50	- 10

**DTH-RO-66000-PU****Stangendichtung / Rod Seal**

Nummer:	d	D	b	Nummer:	d	D	b
RO-66000-0080-1	40	- 55	- 10	RO-66000-0130-1	65	- 75	- 11,5
RO-66000-0080-2	40	- 50	- 7,3	RO-66000-0130-3	65	- 75	- 13
RO-66000-0080-3	40	- 60	- 11,5	RO-66000-0130-4	65	- 75	- 6
RO-66000-0080-4	40	- 48	- 5,7	RO-66000-0130-5	65	- 80	- 9
RO-66000-0080-5	40	- 50	- 9	RO-66000-0130-6	65	- 78	- 10
RO-66000-0080-6	40	- 50	- 7	RO-66000-0130-7	65	- 80	- 12
RO-66000-0080-7	40	- 55	- 11,5	RO-66000-0140	70	- 80	- 12
RO-66000-0080-8	40	- 50	- 6	RO-66000-0140-1	70	- 78	- 11,5
RO-66000-0080-9	40	- 48	- 6	RO-66000-0140-2	70	- 80	- 11,5
RO-66000-0084	42	- 50	- 5,7	RO-66000-0140-3	70	- 85	- 11,5
RO-66000-0090	45	- 55	- 10	RO-66000-0140-4	70	- 85	- 12
RO-66000-0090-1	45	- 60	- 10	RO-66000-0140-5	70	- 90	- 12
RO-66000-0090-2	45	- 55	- 7	RO-66000-0140-6	70	- 85	- 13
RO-66000-0090-3	45	- 55	- 7,3	RO-66000-0140-7	70	- 80	- 6
RO-66000-0090-4	45	- 60	- 11,5	RO-66000-0140-8	70	- 85	- 9
RO-66000-0090-5	45	- 55	- 6	RO-66000-0140-9	70	- 80	- 10
RO-66000-0090-6	45	- 55	- 8	RO-66000-0140-10	70	- 78	- 8
RO-66000-0090-7	45	- 53	- 5,6	RO-66000-0150	75	- 85	- 12
RO-66000-0100	50	- 60	- 10	RO-66000-0150-1	75	- 83	- 11,5
RO-66000-0100-1	50	- 65	- 10	RO-66000-0150-2	75	- 85	- 11,5
RO-66000-0100-2	50	- 60	- 12	RO-66000-0150-3	75	- 90	- 12
RO-66000-0100-3	50	- 60	- 7,5	RO-66000-0150-4	75	- 90	- 11,5
RO-66000-0100-4	50	- 60	- 7,3	RO-66000-0150-5	75	- 85	- 6
RO-66000-0100-5	50	- 65	- 11,5	RO-66000-0150-6	75	- 90	- 9
RO-66000-0100-6	50	- 60	- 7	RO-66000-0154	77	- 87	- 12
RO-66000-0100-7	50	- 60	- 6	RO-66000-0160	80	- 90	- 12
RO-66000-0100-8	50	- 60	- 8	RO-66000-0160-1	80	- 88	- 11,5
RO-66000-0110	55	- 65	- 10	RO-66000-0160-2	80	- 95	- 11,5
RO-66000-0110-1	55	- 63	- 11,5	RO-66000-0160-5	80	- 95	- 12
RO-66000-0110-2	55	- 70	- 11,5	RO-66000-0160-7	80	- 95	- 10
RO-66000-0110-3	55	- 65	- 6	RO-66000-0160-8	80	- 90	- 6
RO-66000-0110-4	55	- 65	- 8	RO-66000-0160-9	80	- 90	- 9
RO-66000-0110-5	55	- 68	- 10	RO-66000-0170	85	- 95	- 12
RO-66000-0112	56	- 66	- 8	RO-66000-0170-1	85	- 93	- 12
RO-66000-0112-1	56	- 66	- 6,5	RO-66000-0180-1	90	- 98	- 11,5
RO-66000-0112-2	56	- 71	- 11,5	RO-66000-0180-4	90	- 98	- 10,9
RO-66000-0120	60	- 80	- 12	RO-66000-0160-3	80	- 100	- 12
RO-66000-0120-1	60	- 70	- 11,5	RO-66000-0160-4	80	- 100	- 15
RO-66000-0120-2	60	- 75	- 12	RO-66000-0160-6	80	- 100	- 10
RO-66000-0120-3	60	- 70	- 10	RO-66000-0170-2	85	- 100	- 12
RO-66000-0120-4	60	- 70	- 12	RO-66000-0170-3	85	- 105	- 12
RO-66000-0120-5	60	- 75	- 10	RO-66000-0170-4	85	- 100	- 9
RO-66000-0120-6	60	- 70	- 7	RO-66000-0180	90	- 100	- 12
RO-66000-0120-7	60	- 70	- 6	RO-66000-0180-2	90	- 100	- 10
RO-66000-0120-8	60	- 73	- 10	RO-66000-0180-3	90	- 110	- 10
RO-66000-0126	63	- 83	- 12	RO-66000-0180-5	90	- 105	- 12
RO-66000-0126-1	63	- 78	- 11,5	RO-66000-0180-6	90	- 110	- 13
RO-66000-0126-2	63	- 78	- 10	RO-66000-0180-7	90	- 100	- 11,5
RO-66000-0126-5	63	- 73	- 12	RO-66000-0180-8	90	- 100	- 7
RO-66000-0126-6	63	- 73	- 10	RO-66000-0180-9	90	- 110	- 12
RO-66000-0130	65	- 75	- 10	RO-66000-0180-10	90	- 110	- 15



**DTH-RO-66000-PU****Stangendichtung / Rod Seal**

Nummer:	d	D	b	Nummer:	d	D	b
RO-66000-0180-11	90	- 105	- 11,5	RO-66000-0260-1	130	- 138	- 11,5
RO-66000-0180-12	90	- 105	- 9	RO-66000-0260-2	130	- 150	- 15
RO-66000-0180-13	90	- 98	- 8	RO-66000-0260-3	130	- 145	- 13
RO-66000-0190	95	- 105	- 12	RO-66000-0270	135	- 145	- 12
RO-66000-0190-1	95	- 103	- 11,5	RO-66000-0270-1	135	- 150	- 11,5
RO-66000-0190-2	95	- 110	- 10	RO-66000-0280	140	- 160	- 15
RO-66000-0190-3	95	- 115	- 12	RO-66000-0280-1	140	- 160	- 14,5
RO-66000-0190-4	95	- 110	- 9	RO-66000-0280-2	140	- 160	- 12
RO-66000-0190-5	95	- 110	- 12	RO-66000-0280-3	140	- 150	- 11,5
RO-66000-0200	100	- 115	- 12	RO-66000-0280-4	140	- 170	- 18
RO-66000-0200-1	100	- 110	- 11,5	RO-66000-0284	142	- 157	- 12
RO-66000-0200-2	100	- 108	- 11,5	RO-66000-0286	143	- 151	- 11,5
RO-66000-0200-3	100	- 115	- 11	RO-66000-0290	145	- 155	- 12
RO-66000-0200-4	100	- 120	- 12	RO-66000-0300	150	- 170	- 14
RO-66000-0200-5	100	- 130	- 12	RO-66000-0300-1	150	- 180	- 18
RO-66000-0200-6	100	- 125	- 15	RO-66000-0300-2	150	- 170	- 12
RO-66000-0200-7	100	- 120	- 14	RO-66000-0300-3	150	- 170	- 15
RO-66000-0200-8	100	- 115	- 9	RO-66000-0310	155	- 165	- 12
RO-66000-0200-9	100	- 120	- 15	RO-66000-0310-1	155	- 163	- 11,5
RO-66000-0210	105	- 115	- 12	RO-66000-0320	160	- 170	- 12
RO-66000-0210-1	105	- 120	- 10	RO-66000-0320-1	160	- 185	- 15
RO-66000-0210-2	105	- 113	- 11,5	RO-66000-0320-2	160	- 170	- 11,5
RO-66000-0210-3	105	- 115	- 11,5	RO-66000-0320-3	160	- 180	- 15
RO-66000-0210-4	105	- 125	- 12	RO-66000-0330-1	165	- 175	- 12
RO-66000-0212	106	- 120	- 8,4	RO-66000-0340	170	- 200	- 15
RO-66000-0220	110	- 118	- 11,5	RO-66000-0344	172	- 187	- 12
RO-66000-0220-1	110	- 125	- 12	RO-66000-0344-1	172	- 197	- 15
RO-66000-0220-2	110	- 130	- 15	RO-66000-0350	175	- 215	- 20
RO-66000-0220-3	110	- 125	- 11	RO-66000-0350-1	175	- 185	- 12
RO-66000-0220-4	110	- 130	- 12	RO-66000-0360	180	- 200	- 15
RO-66000-0220-5	110	- 125	- 15	RO-66000-0360-1	180	- 195	- 11,5
RO-66000-0220-6	110	- 125	- 9	RO-66000-0370	185	- 195	- 12
RO-66000-0226	113	- 128	- 12	RO-66000-0380	190	- 210	- 15
RO-66000-0230	115	- 125	- 12	RO-66000-0384	192	- 212	- 12
RO-66000-0230-1	115	- 135	- 12	RO-66000-0400	200	- 212	- 15
RO-66000-0234	117	- 133	- 9	RO-66000-0400-1	200	- 220	- 15
RO-66000-0236	118	- 126	- 11,5	RO-66000-0420	210	- 230	- 15
RO-66000-0240	120	- 140	- 15	RO-66000-0424	212	- 222	- 12
RO-66000-0240-1	120	- 135	- 15	RO-66000-0430	215	- 235	- 12
RO-66000-0240-2	120	- 140	- 12	RO-66000-0440	220	- 250	- 18
RO-66000-0240-3	120	- 130	- 11,5	RO-66000-0460	230	- 260	- 18
RO-66000-0240-4	120	- 150	- 15	RO-66000-0470	235	- 255	- 12
RO-66000-0240-5	120	- 140	- 14,6	RO-66000-0480	240	- 260	- 15
RO-66000-0240-6	120	- 135	- 9	RO-66000-0490	245	- 275	- 18
RO-66000-0246	123	- 132	- 12	RO-66000-0504	252	- 273	- 10
RO-66000-0250	125	- 150	- 14	RO-66000-0516	258	- 278	- 15
RO-66000-0250-1	125	- 145	- 15	RO-66000-0560	280	- 310	- 18
RO-66000-0250-2	125	- 133	- 11,5	RO-66000-0560-1	280	- 300	- 15
RO-66000-0250-3	125	- 145	- 12	RO-66000-0600	300	- 330	- 17
RO-66000-0250-4	125	- 135	- 12				
RO-66000-0260	130	- 145	- 9				

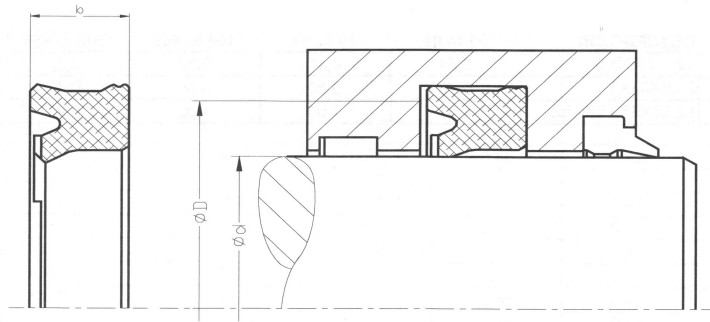

## DTH-RO-192000-NB

## Stangendichtung / Rod Seal

Nummer:	d	D	b	Nummer:	d	D	b
RO-192000- 0080	40	- 50	- 7	RO-192000- 0180	90	- 105	- 10
RO-192000- 0090	45	- 55	- 7	RO-192000- 0190	95	- 110	- 10,5
RO-192000- 0100	50	- 63	- 10	RO-192000- 0200	100	- 115	- 10
RO-192000- 0110	55	- 68	- 10	RO-192000- 0220	110	- 130	- 10
RO-192000- 0130	65	- 78	- 10	RO-192000- 0240	120	- 140	- 10
RO-192000- 0140	70	- 83	- 10	RO-192000- 0280	140	- 160	- 12
RO-192000- 0150	75	- 88	- 10	RO-192000- 0280-1	140	- 160	- 10
RO-192000- 0160	80	- 93	- 10	RO-192000- 0360	180	- 200	- 12
RO-192000- 0170	85	- 100	- 10				

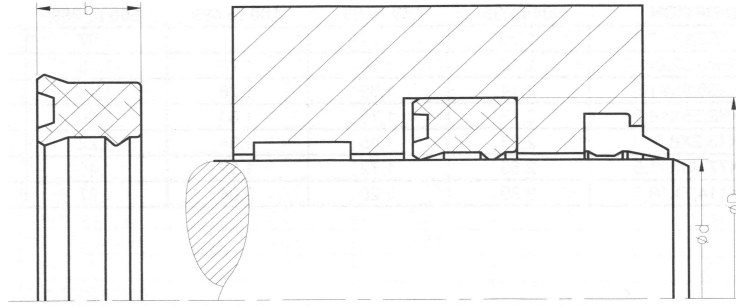

## DTH-RO-76000-PU

## Stangendichtung / Rod Seal

Nummer:	d	D	b	Nummer:	d	D	b
RO-76000-0012	6	- 14	- 5,8	RO-76000-0064-4	32	- 42	- 8
RO-76000-0016	8	- 16	- 5,8	RO-76000-0068	34	- 50	- 10
RO-76000-0020	10	- 18	- 5,8	RO-76000-0070	35	- 43	- 5,8
RO-76000-0024	12	- 19	- 5,7	RO-76000-0070-1	35	- 43	- 8
RO-76000-0024-1	12	- 20	- 5,8	RO-76000-0070-2	35	- 45	- 10
RO-76000-0028	14	- 22	- 5,8	RO-76000-0070-3	35	- 50	- 10
RO-76000-0030	15	- 21,5	- 4,2	RO-76000-0070-4	35	- 45	- 7
RO-76000-0032	16	- 24	- 5,8	RO-76000-0072	36	- 44	- 5,8
RO-76000-0032-1	16	- 22	- 4	RO-76000-0072-1	36	- 44	- 8
RO-76000-0036	18	- 26	- 5,8	RO-76000-0074	37	- 47	- 10
RO-76000-0036-1	18	- 26	- 8	RO-76000-0076	38	- 50	- 8,5
RO-76000-0036-2	18	- 25	- 5	RO-76000-0080	40	- 48	- 5,8
RO-76000-0040	20	- 27	- 5,8	RO-76000-0080-1	40	- 48	- 8
RO-76000-0040-1	20	- 28	- 5,8	RO-76000-0080-2	40	- 50	- 7
RO-76000-0040-2	20	- 30	- 7	RO-76000-0080-3	40	- 50	- 10
RO-76000-0044	22	- 28	- 4,5	RO-76000-0080-4	40	- 55	- 10
RO-76000-0044-1	22	- 30	- 5,8	RO-76000-0080-5	40	- 60	- 10
RO-76000-0044-2	22	- 30	- 7	RO-76000-0080-6	40	- 50	- 8
RO-76000-0044-3	22	- 32	- 8	RO-76000-0080-7	40	- 48	- 6
RO-76000-0048	24,5	- 30	- 4,5	RO-76000-0084	42	- 50	- 6
RO-76000-0050	25	- 33	- 5,8	RO-76000-0084-1	42	- 52	- 8
RO-76000-0050-1	25	- 33	- 7	RO-76000-0090	45	- 53	- 5,8
RO-76000-0050-2	25	- 35	- 7	RO-76000-0090-1	45	- 55	- 5,8
RO-76000-0050-3	25	- 35	- 10	RO-76000-0090-2	45	- 55	- 7
RO-76000-0056	28	- 38	- 5,8	RO-76000-0090-3	45	- 55	- 10
RO-76000-0056-1	28	- 38	- 7	RO-76000-0090-4	45	- 52	- 12
RO-76000-0056-2	28	- 36	- 6,3	RO-76000-0092	46	- 54	- 8
RO-76000-0056-3	28	- 36	- 5,8	RO-76000-0096	48	- 60	- 6
RO-76000-0060	30	- 38	- 5,8	RO-76000-0100	50	- 58	- 8
RO-76000-0060-1	30	- 38	- 8	RO-76000-0100-1	50	- 60	- 7
RO-76000-0060-2	30	- 36	- 6	RO-76000-0100-2	50	- 60	- 9
RO-76000-0060-3	30	- 40	- 6,5	RO-76000-0100-3	50	- 60	- 10
RO-76000-0060-4	30	- 40	- 10	RO-76000-0100-4	50	- 65	- 10
RO-76000-0060-5	30	- 40	- 7	RO-76000-0100-5	50	- 70	- 13,5
RO-76000-0064	32	- 40	- 8	RO-76000-0110	55	- 63	- 8
RO-76000-0064-1	32	- 42	- 7	RO-76000-0110-1	55	- 65	- 10
RO-76000-0064-2	32	- 40	- 7	RO-76000-0110-2	55	- 65	- 12
RO-76000-0064-3	32	- 40	- 6,5	RO-76000-0110-3	55	- 65	- 8

**DTH-RO-76000-PU****Stangendichtung / Rod Seal**

Nummer:	d	D	b	Nummer:	d	D	b
RO-76000-0112	56	- 66	- 6,5	RO-76000-0180-3	90	- 110	- 14
RO-76000-0112-1	56	- 71	- 11,5	RO-76000-0190	95	- 103	- 8
RO-76000-0112-2	56	- 64	- 8	RO-76000-0190-1	95	- 105	- 8
RO-76000-0120	60	- 68	- 8	RO-76000-0194	97	- 105	- 13
RO-76000-0120-1	60	- 70	- 7,5	RO-76000-0194-1	97	- 105	- 12
RO-76000-0120-2	60	- 70	- 10	RO-76000-0200	100	- 108	- 11,5
RO-76000-0120-3	60	- 70	- 11,5	RO-76000-0200-1	100	- 115	- 12
RO-76000-0120-4	60	- 72	- 9	RO-76000-0200-2	100	- 120	- 15
RO-76000-0120-5	60	- 68	- 12	RO-76000-0208	104	- 112	- 8
RO-76000-0120-6	60	- 70	- 7	RO-76000-0210	105	- 113	- 8
RO-76000-0122	61	- 69	- 8	RO-76000-0212	106	- 116	- 8
RO-76000-0126	63	- 71	- 8	RO-76000-0214	107	- 115	- 8
RO-76000-0126-2	63	- 75	- 8,6	RO-76000-0216	108	- 116	- 8
RO-76000-0130	65	- 73	- 8	RO-76000-0220	110	- 130	- 15
RO-76000-0130-1	65	- 75	- 12,5	RO-76000-0220-1	110	- 125	- 9,5
RO-76000-0136	68	- 76	- 8	RO-76000-0224	112	- 127	- 12
RO-76000-0140	70	- 78	- 8	RO-76000-0230	115	- 123	- 8
RO-76000-0140-1	70	- 80	- 12	RO-76000-0230-1	115	- 125	- 8
RO-76000-0140-2	70	- 85	- 11,5	RO-76000-0230-2	115	- 124	- 15
RO-76000-0140-3	70	- 82	- 9	RO-76000-0236	118	- 126	- 13
RO-76000-0140-4	70	- 80	- 6,5	RO-76000-0240	120	- 128	- 11,5
RO-76000-0148	74	- 82	- 8	RO-76000-0240-1	120	- 135	- 15
RO-76000-0150	75	- 83	- 8	RO-76000-0244	122	- 128	- 8
RO-76000-0150-1	75	- 85	- 8	RO-76000-0250	125	- 145	- 15
RO-76000-0152	76	- 84	- 8	RO-76000-0252	126	- 134	- 8
RO-76000-0156	78	- 86	- 12	RO-76000-0270	135	- 143	- 11,5
RO-76000-0160	80	- 88	- 8	RO-76000-0270-1	135	- 145	- 8
RO-76000-0160-1	80	- 90	- 10	RO-76000-0284	142	- 148	- 8
RO-76000-0160-2	80	- 90	- 12	RO-76000-0290	145	- 153	- 8
RO-76000-0160-3	80	- 95	- 11,5	RO-76000-0310	155	- 163	- 11,5
RO-76000-0160-4	80	- 96	- 9,5	RO-76000-0310-1	155	- 170	- 11,5
RO-76000-0160-5	80	- 92	- 9	RO-76000-0320	160	- 170	- 8
RO-76000-0190	85	- 93	- 8	RO-76000-0330	165	- 173	- 8
RO-76000-0190-1	85	- 95	- 12	RO-76000-0332	165	- 176	- 12
RO-76000-0176	88	- 96	- 8	RO-76000-0360	180	- 190	- 11
RO-76000-0180	90	- 98	- 8	RO-76000-0370	185	- 195	- 8
RO-76000-0182	91	- 99	- 8	RO-76000-0416	208	- 218	- 8
RO-76000-0172	86	- 101	- 12	RO-76000-0420	210	- 220	- 11
RO-76000-0180-1	90	- 102	- 9	RO-76000-0424	212	- 223	- 8
RO-76000-0180-2	90	- 105	- 11,5				

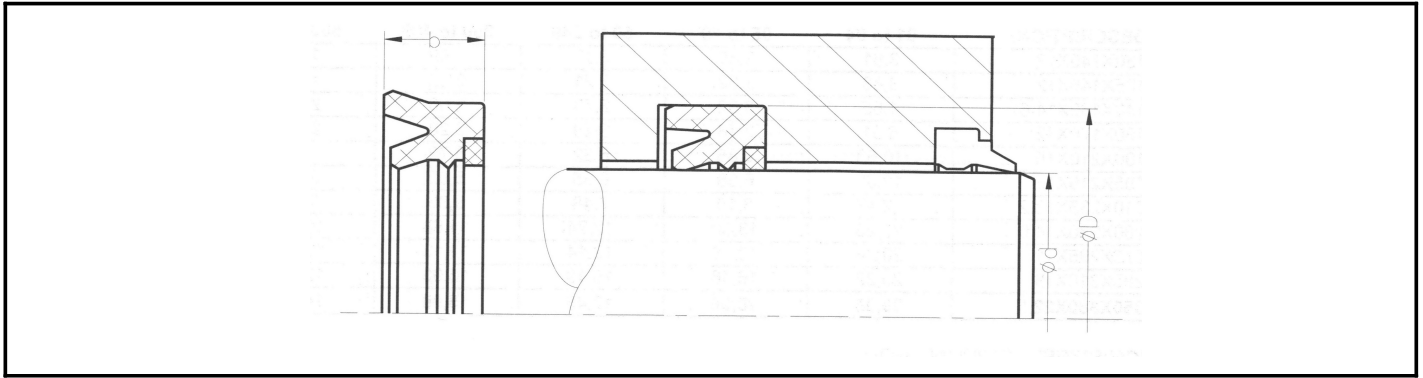

## DTH-RO-64000-PU

## Stangendichtung / Rod Seal

Nummer:	d	D	b	Nummer:	d	D	b
RO-64000-0044	22	- 30	- 6	RO-64000-0150	75	- 85	- 12
RO-64000-0050	25	- 35	- 5	RO-64000-0160	80	- 90	- 12
RO-64000-0056	28	- 38	- 6	RO-64000-0160-1	80	- 92	- 11
RO-64000-0056-1	28	- 35,5	- 5	RO-64000-0170	85	- 100	- 12
RO-64000-0060	30	- 40	- 8	RO-64000-0180	90	- 100	- 12
RO-64000-0064	32	- 45	- 9,5	RO-64000-0190	95	- 105	- 12
RO-64000-0070	35	- 45	- 8	RO-64000-0200	100	- 115	- 12
RO-64000-0070-1	35	- 45	- 7	RO-64000-0200-1	100	- 120	- 12
RO-64000-0072	36	- 46	- 8	RO-64000-0210	105	- 115	- 12
RO-64000-0080	40	- 50	- 10	RO-64000-0220	110	- 125	- 14,6
RO-64000-0080-1	40	- 52	- 12	RO-64000-0220-1	110	- 130	- 15
RO-64000-0080-2	40	- 52	- 10,9	RO-64000-0230	115	- 125	- 12
RO-64000-0080-3	40	- 48	- 8	RO-64000-0240	120	- 140	- 14,6
RO-64000-0090	45	- 55	- 10	RO-64000-0250	125	- 145	- 12
RO-64000-0100	50	- 60	- 10	RO-64000-0260	130	- 140	- 12
RO-64000-0100-1	50	- 62	- 8	RO-64000-0270	135	- 145	- 12
RO-64000-0104	52	- 68	- 10	RO-64000-0280	140	- 160	- 14,6
RO-64000-0110	55	- 65	- 10	RO-64000-0320	160	- 170	- 12
RO-64000-0110-1	55	- 65	- 12	RO-64000-0380	190	- 210	- 15
RO-64000-0112	56	- 71	- 10	RO-64000-0390	195	- 215	- 15
RO-64000-0120	60	- 70	- 10	RO-64000-0420	210	- 235	- 18,2
RO-64000-0126	63	- 75	- 8	RO-64000-0520	260	- 280	- 14,6
RO-64000-0126-1	63	- 78	- 10,8	RO-64000-0550	275	- 295	- 11
RO-64000-0130	65	- 80	- 12	RO-64000-0570	285	- 310	- 19
RO-64000-0140	70	- 80	- 10	RO-64000-0700	350	- 380	- 22,5
RO-64000-0140-1	70	- 82	- 12				

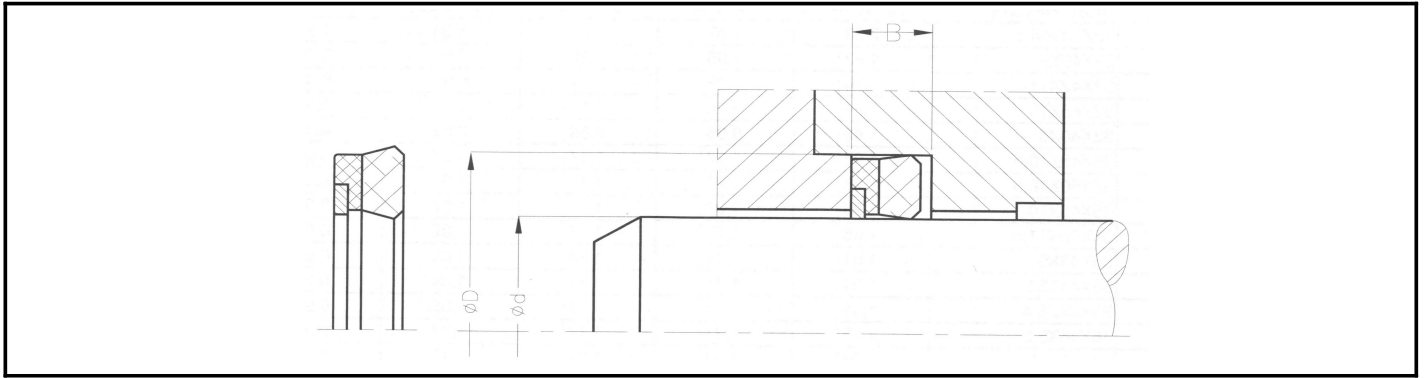

**DTH-RO-74000-NB-FA-POM**

**Stangendichtung / Rod Seal**

Nummer:	d	D	b	Nummer:	d	D	b
RO-74000-0012	6	- 14	- 6,5	RO-74000-0064	32	- 40	- 9
RO-74000-0024	12	- 23	- 7,5	RO-74000-0064-1	32	- 42	- 11
RO-74000-0030	15	- 27	- 7	RO-74000-0064-2	32	- 45	- 10
RO-74000-0032	16	- 28	- 7,5	RO-74000-0064-3	32	- 40	- 5
RO-74000-0032-1	16	- 24	- 7	RO-74000-0070	35	- 45	- 10,5
RO-74000-0036	18	- 26	- 6,4	RO-74000-0070-1	35	- 50	- 10,5
RO-74000-0036-1	18	- 28	- 6,3	RO-74000-0070-2	35	- 45	- 10
RO-74000-0036-2	18	- 30	- 7,5	RO-74000-0070-3	35	- 50	- 11,5
RO-74000-0040	20	- 30	- 8	RO-74000-0070-4	35	- 43	- 6
RO-74000-0040-1	20	- 27	- 6	RO-74000-0072	36	- 43	- 6,5
RO-74000-0040-2	20	- 28	- 6,3	RO-74000-0072-1	36	- 44	- 6,4
RO-74000-0040-3	20	- 28	- 7	RO-74000-0072-2	36	- 46	- 8,5
RO-74000-0040-4	20	- 30	- 8,5	RO-74000-0072-3	36	- 48	- 12
RO-74000-0040-5	20	- 28	- 5,6	RO-74000-0072-4	36	- 48	- 9,5
RO-74000-0044	22	- 32	- 7,5	RO-74000-0076	38	- 55	- 10,5
RO-74000-0044-1	22	- 29	- 5	RO-74000-0080	40	- 50	- 10,5
RO-74000-0044-2	22	- 30	- 7	RO-74000-0080-1	40	- 55	- 10,5
RO-74000-0044-3	22	- 32	- 10	RO-74000-0080-2	40	- 50	- 11
RO-74000-0044-4	22	- 34	- 9,5	RO-74000-0080-3	40	- 48	- 6,5
RO-74000-0044-5	22	- 35	- 10	RO-74000-0080-4	40	- 55	- 11
RO-74000-0050	25	- 38	- 9,5	RO-74000-0080-5	40	- 50	- 10
RO-74000-0050-1	25	- 33	- 6	RO-74000-0080-6	40	- 50	- 8
RO-74000-0050-2	25	- 35	- 8	RO-74000-0080-7	40	- 55	- 8
RO-74000-0050-3	25	- 33	- 6,4	RO-74000-0080-8	40	- 60	- 14,5
RO-74000-0050-4	25	- 35	- 9	RO-74000-0084	42	- 52	- 9
RO-74000-0050-5	25	- 38	- 10	RO-74000-0090	45	- 55	- 10,5
RO-74000-0050-7	25	- 33	- 7	RO-74000-0090-1	45	- 60	- 10,5
RO-74000-0056	28	- 38	- 8	RO-74000-0090-2	45	- 55	- 11
RO-74000-0056-1	28	- 41	- 9,5	RO-74000-0090-3	45	- 55	- 8
RO-74000-0056-2	28	- 36	- 6,4	RO-74000-0090-4	45	- 55	- 7,5
RO-74000-0056-3	28	- 40	- 9,5	RO-74000-0090-5	45	- 57	- 10
RO-74000-0056-4	28	- 41	- 10	RO-74000-0090-6	45	- 65	- 14,5
RO-74000-0060	30	- 40	- 10,5	RO-74000-0100	50	- 65	- 10,5
RO-74000-0060-1	30	- 38	- 6,5	RO-74000-0100-1	50	- 62	- 10
RO-74000-0060-2	30	- 40	- 7	RO-74000-0100-2	50	- 60	- 10,5
RO-74000-0060-3	30	- 40	- 7,5	RO-74000-0100-3	50	- 60	- 10
RO-74000-0060-4	30	- 45	- 9	RO-74000-0100-4	50	- 65	- 11
RO-74000-0060-5	30	- 50	- 14,5	RO-74000-0100-5	50	- 62	- 8

## DTH-RO-74000-NB-FA-POM

## Stangendichtung / Rod Seal

Nummer:	d	D	b	Nummer:	d	D	b
RO-74000-0100-6	50	- 70	- 14	RO-74000-0160	80	- 90	- 12,5
RO-74000-0100-7	50	- 60	- 7,5	RO-74000-0160-3	80	- 95	- 12
RO-74000-0100-8	50	- 60	- 8	RO-74000-0160-4	80	- 93	- 14,5
RO-74000-0100-9	50	- 70	- 14,5	RO-74000-0160-5	80	- 96	- 10,5
RO-74000-0108	54	- 66	- 9,5	RO-74000-0160-8	80	- 95	- 10
RO-74000-0110	55	- 65	- 10,5	RO-74000-0170-1	85	- 95	- 8
RO-74000-0110-1	55	- 65	- 12	RO-74000-0160-1	80	- 100	- 12,5
RO-74000-0110-2	55	- 65	- 11	RO-74000-0160-2	80	- 100	- 14
RO-74000-0110-3	55	- 75	- 14	RO-74000-0160-6	80	- 100	- 12
RO-74000-0110-4	55	- 65	- 8	RO-74000-0160-7	80	- 100	- 14,5
RO-74000-0110-5	55	- 70	- 10,5	RO-74000-0170	85	- 100	- 12,5
RO-74000-0110-6	55	- 75	- 14,5	RO-74000-0170-2	85	- 100	- 12
RO-74000-0112	56	- 66	- 10,5	RO-74000-0170-3	85	- 105	- 14,5
RO-74000-0112-1	56	- 71	- 10,5	RO-74000-0180	90	- 105	- 12,5
RO-74000-0112-2	56	- 76	- 14,5	RO-74000-0180-1	90	- 110	- 12,5
RO-74000-0120	60	- 70	- 10,5	RO-74000-0180-2	90	- 105	- 9,5
RO-74000-0120-1	60	- 70	- 12,5	RO-74000-0180-4	90	- 106,2	- 10,8
RO-74000-0120-2	60	- 80	- 14	RO-74000-0180-5	90	- 110	- 12
RO-74000-0120-3	60	- 75	- 13	RO-74000-0190	95	- 105	- 11
RO-74000-0120-4	60	- 75	- 12,5	RO-74000-0190-1	95	- 112	- 12
RO-74000-0120-5	60	- 69,5	- 7	RO-74000-0190-2	95	- 115	- 14,5
RO-74000-0120-6	60	- 70	- 11	RO-74000-0190-3	95	- 110	- 12
RO-74000-0120-7	60	- 70	- 8	RO-74000-0190-4	95	- 115	- 12
RO-74000-0120-8	60	- 70	- 13	RO-74000-0200	100	- 115	- 12,5
RO-74000-0120-9	60	- 72	- 10	RO-74000-0200-1	100	- 120	- 14
RO-74000-0120-11	60	- 80	- 14,5	RO-74000-0200-2	100	- 125	- 20
RO-74000-0126	63	- 71	- 9	RO-74000-0200-3	100	- 120	- 24,5
RO-74000-0126-1	63	- 75	- 11	RO-74000-0200-4	100	- 115	- 11,5
RO-74000-0126-2	63	- 78	- 12,5	RO-74000-0200-5	100	- 120	- 12
RO-74000-0126-3	63	- 83	- 14,5	RO-74000-0200-6	100	- 120	- 14,5
RO-74000-0130	65	- 80	- 12,5	RO-74000-0210	105	- 115	- 11
RO-74000-0130-1	65	- 75	- 12,5	RO-74000-0210-1	105	- 125	- 12,5
RO-74000-0130-2	65	- 75	- 13,5	RO-74000-0220	110	- 130	- 12,5
RO-74000-0130-3	65	- 77	- 9,6	RO-74000-0220-1	110	- 125	- 12
RO-74000-0130-4	65	- 80	- 11,5	RO-74000-0220-2	110	- 135	- 15,5
RO-74000-0140	70	- 80	- 12,5	RO-74000-0240	120	- 130	- 10,5
RO-74000-0140-1	70	- 85	- 12	RO-74000-0240-1	120	- 132,7	- 10
RO-74000-0140-2	70	- 85	- 12,5	RO-74000-0240-2	120	- 135	- 12,5
RO-74000-0140-3	70	- 90	- 14	RO-74000-0240-3	120	- 140	- 12,5
RO-74000-0140-4	70	- 80	- 8	RO-74000-0240-4	120	- 145	- 18,8
RO-74000-0140-5	70	- 80	- 13	RO-74000-0250	125	- 150	- 14
RO-74000-0140-6	70	- 82	- 10,5	RO-74000-0250-1	125	- 150	- 14,5
RO-74000-0140-7	70	- 84	- 12,5	RO-74000-0260	130	- 145	- 13
RO-74000-0140-8	70	- 90	- 12	RO-74000-0260-1	130	- 145	- 15
RO-74000-0150	75	- 85	- 12,5	RO-74000-0260-2	130	- 150	- 16
RO-74000-0150-1	75	- 90	- 11	RO-74000-0270	135	- 150	- 14
RO-74000-0150-2	75	- 85	- 11	RO-74000-0270-1	135	- 160	- 14
RO-74000-0150-3	75	- 90	- 11,5	RO-74000-0280	140	- 160	- 12
RO-74000-0150-4	75	- 90	- 12,8	RO-74000-0280-1	140	- 155	- 13
RO-74000-0150-5	75	- 95	- 14,5	RO-74000-0280-2	140	- 160	- 14,5

**DTH-RO-74000-NB-FA-POM****Stangendichtung / Rod Seal**

Nummer:	d	D	b	Nummer:	d	D	b
RO-74000-0280-3	140	- 160	- 12,5	RO-74000-0360	180	- 200	- 14,5
RO-74000-0280-4	140	- 170	- 22,8	RO-74000-0360-1	180	- 210	- 20,5
RO-74000-0290	145	- 157,7	- 10	RO-74000-0380	190	- 210	- 14,5
RO-74000-0300	150	- 170	- 14	RO-74000-0396	198	- 208	- 12
RO-74000-0300-1	150	- 170	- 14,5	RO-74000-0400	200	- 220	- 14,5
RO-74000-0320	160	- 175	- 16	RO-74000-0420	210	- 240	- 22,5
RO-74000-0320-1	160	- 180	- 14,5	RO-74000-0440	220	- 250	- 20,5
RO-74000-0350	175	- 200	- 23	RO-74000-0460	230	- 260	- 20,5



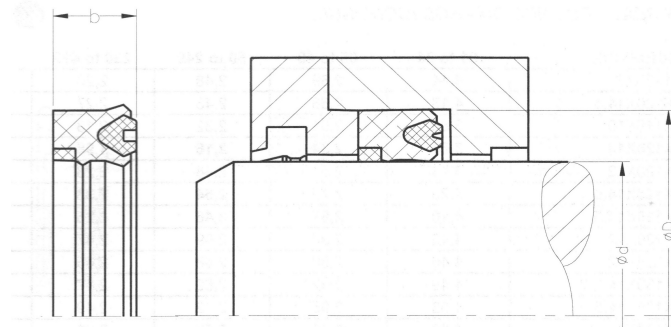

## DTH-RO-62000-PU

## Schwerhydraulik Stangendichtung / Heavy Duty Rod Seal

Nummer:	d	D	b	Nummer:	d	D	b
RO-62000-0050	25	- 35	- 7,3	RO-62000-0170-2	85	- 97	- 8,6
RO-62000-0060	30	- 40	- 10	RO-62000-0180	90	- 105	- 11,4
RO-62000-0060-1	30	- 40	- 7,3	RO-62000-0180-1	90	- 105	- 10
RO-62000-0070	35	- 50	- 9,5	RO-62000-0180-2	90	- 110	- 17
RO-62000-0080	40	- 55	- 9,5	RO-62000-0180-3	90	- 110	- 14,5
RO-62000-0080-1	40	- 50	- 7,3	RO-62000-0180-4	90	- 100	- 12
RO-62000-0080-2	40	- 55	- 11,4	RO-62000-0180-5	90	- 105	- 15
RO-62000-0090	45	- 60	- 11,4	RO-62000-0190	95	- 110	- 10
RO-62000-0100	50	- 65	- 11,4	RO-62000-0190-1	95	- 115	- 15
RO-62000-0100-3	50	- 60	- 7,3	RO-62000-0200	100	- 120	- 14,5
RO-62000-0110	55	- 70	- 11,4	RO-62000-0200-1	100	- 115	- 10
RO-62000-0110-1	55	- 68	- 13	RO-62000-0200-2	100	- 120	- 14
RO-62000-0120	60	- 75	- 11,4	RO-62000-0210	105	- 120	- 12
RO-62000-0120-1	60	- 73	- 13	RO-62000-0210-1	105	- 125	- 14,5
RO-62000-0120-2	60	- 72	- 8,6	RO-62000-0210-2	105	- 120	- 14,5
RO-62000-0126-1	63	- 75	- 8,7	RO-62000-0220	110	- 130	- 12
RO-62000-0130	65	- 78	- 10	RO-62000-0220-1	110	- 125	- 12
RO-62000-0130-1	65	- 80	- 9	RO-62000-0220-2	110	- 130	- 14,5
RO-62000-0140	70	- 85	- 11,4	RO-62000-0230	115	- 135	- 14,5
RO-62000-0140-1	70	- 83	- 10	RO-62000-0230-1	115	- 130	- 15
RO-62000-0140-2	70	- 85	- 9	RO-62000-0240	120	- 140	- 12
RO-62000-0140-3	70	- 80	- 12	RO-62000-0250	125	- 145	- 14,5
RO-62000-0140-4	70	- 85	- 10	RO-62000-0260	130	- 150	- 14,5
RO-62000-0140-5	70	- 82	- 8,6	RO-62000-0280	140	- 160	- 14,5
RO-62000-0150	75	- 88	- 10	RO-62000-0300	150	- 160	- 14,5
RO-62000-0150-1	75	- 90	- 9	RO-62000-0300-1	150	- 170	- 14,5
RO-62000-0160	80	- 95	- 11,4	RO-62000-0460	230	- 250	- 15
RO-62000-0160-1	80	- 93	- 10	RO-62000-0480	240	- 260	- 15
RO-62000-0160-2	80	- 95	- 9	RO-62000-0580	290	- 315	- 19
RO-62000-0170	85	- 100	- 10	RO-62000-0680	340	- 365	- 19
RO-62000-0170-1	85	- 105	- 15				

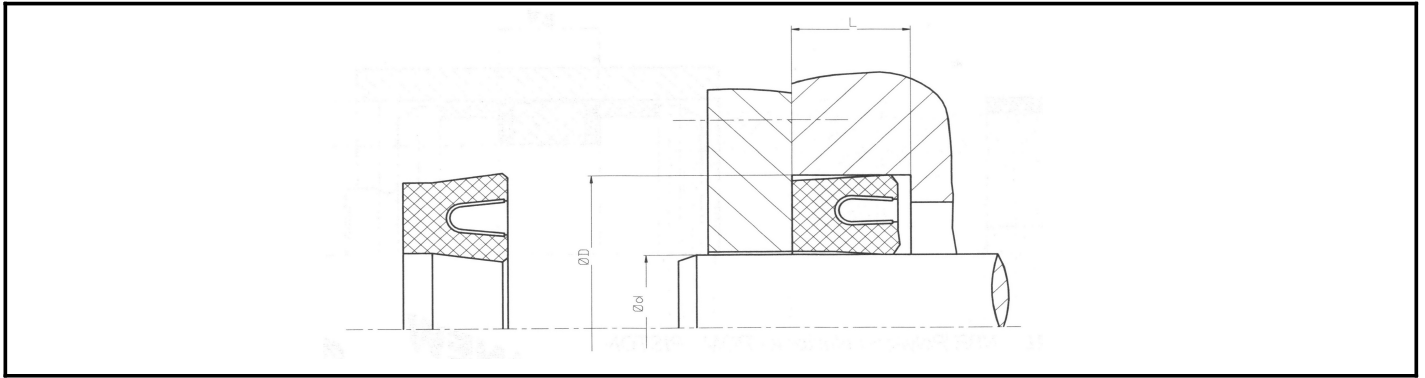

**DTH-RO-1402-PTFE-MET**

**Federvorgespannte Stangendichtung / Spring Loaded Rod Seal**

Nummer:	d	D	b	Nummer:	d	D	b
RO-1402- 0014	7	- 9,9	- 2,4	RO-1402- 0130	65	- 74,4	- 7,1
RO-1402- 0024	12	- 16,5	- 3,6	RO-1402- 0140	70	- 79,4	- 7,1
RO-1402- 0036	18	- 24,2	- 4,8	RO-1402- 0150	75	- 84,4	- 7,1
RO-1402- 0040	20	- 26,2	- 4,8	RO-1402- 0160	80	- 89,4	- 7,1
RO-1402- 0050	25	- 31,2	- 4,8	RO-1402- 0170	85	- 94,4	- 7,1
RO-1402- 0060	30	- 36,2	- 4,8	RO-1402- 0180	90	- 99,4	- 7,1
RO-1402- 0070	35	- 41,2	- 4,8	RO-1402- 0190	95	- 104,4	- 7,1
RO-1402- 0080	40	- 49,4	- 7,1	RO-1402- 0200	100	- 109,4	- 7,1
RO-1402- 0090	45	- 54,4	- 7,1	RO-1402- 0220	110	- 119,4	- 7,1
RO-1402- 0100	50	- 59,4	- 7,1	RO-1402- 0230	115	- 124,4	- 7,1
RO-1402- 0110	55	- 64,4	- 7,1	RO-1402- 0240	120	- 132,2	- 9,5
RO-1402- 0120	60	- 69,4	- 7,1				

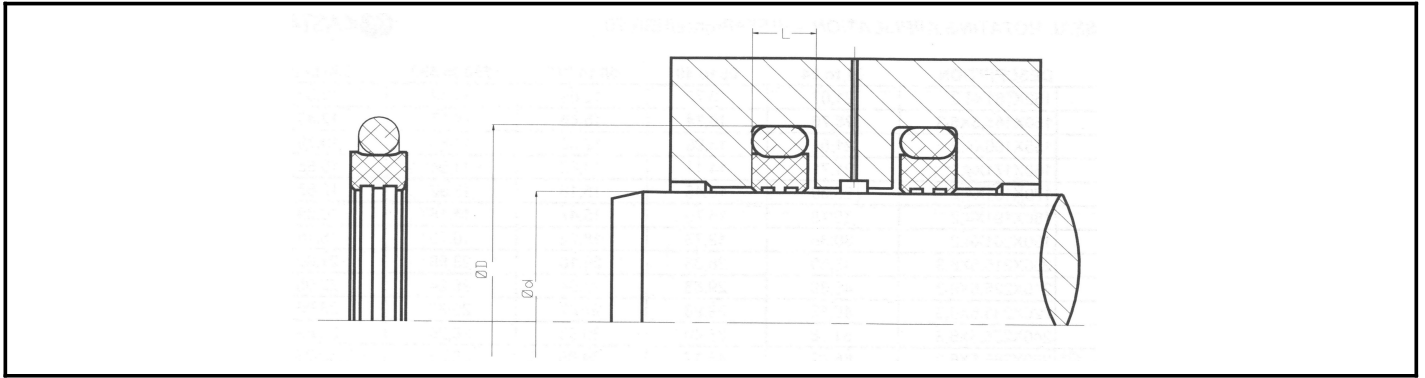

### DTH-RO-1402-PTFE-NB

### Rotor Stangendichtung / Rod Seal for Rotating Applications

Nummer:	d	D	b	Nummer:	d	D	b
RO-1402- 0020	10	- 14,9	- 2,2	RO-1402- 0200	100	- 111	- 4,2
RO-1402- 0024	12	- 16,9	- 2,2	RO-1402- 0200-1	100	- 115,5	- 6,3
RO-1402- 0030	15	- 19,9	- 2,2	RO-1402- 0210	105	- 116	- 4,2
RO-1402- 0040	20	- 27,5	- 3,2	RO-1402- 0220	110	- 121	- 4,2
RO-1402- 0040-1	20	- 24,9	- 2,2	RO-1402- 0230	115	- 126	- 4,2
RO-1402- 0050	25	- 32,5	- 3,2	RO-1402- 0240	120	- 131	- 4,2
RO-1402- 0050-1	25,4	- 32,9	- 3,2	RO-1402- 0250	125	- 136	- 4,2
RO-1402- 0056	28	- 35,5	- 3,2	RO-1402- 0250-1	125	- 140,5	- 6,3
RO-1402- 0060	30	- 37,5	- 3,2	RO-1402- 0260	130	- 141	- 4,2
RO-1402- 0070	35	- 42,5	- 3,2	RO-1402- 0280	140	- 151	- 4,2
RO-1402- 0080	40	- 51	- 4,2	RO-1402- 0280-1	140	- 155,5	- 6,3
RO-1402- 0080-1	40	- 55,5	- 6,3	RO-1402- 0290	145	- 156	- 4,2
RO-1402- 0090	45	- 56	- 4,2	RO-1402- 0300	150	- 161	- 4,2
RO-1402- 0100	50	- 61	- 4,2	RO-1402- 0300-1	150	- 165,5	- 6,3
RO-1402- 0110	55	- 66	- 4,2	RO-1402- 0310	155	- 166	- 4,2
RO-1402- 0112	56	- 67	- 4,2	RO-1402- 0320	160	- 171	- 4,2
RO-1402- 0120	60	- 71	- 4,2	RO-1402- 0340	170	- 181	- 4,2
RO-1402- 0120-1	60	- 75,5	- 6,3	RO-1402- 0360	180	- 191	- 4,2
RO-1402- 0130	65	- 76	- 4,2	RO-1402- 0380	190	- 201	- 4,2
RO-1402- 0140	70	- 81	- 4,2	RO-1402- 0400	200	- 215,5	- 6,3
RO-1402- 0150	75	- 86	- 4,2	RO-1402- 0420	210	- 225,5	- 6,3
RO-1402- 0160	80	- 91	- 4,2	RO-1402- 0440	220	- 235,5	- 6,3
RO-1402- 0160-1	80	- 95,5	- 6,3	RO-1402- 0480	240	- 255,5	- 6,3
RO-1402- 0170	85	- 96	- 4,2	RO-1402- 0500	250	- 265,5	- 6,3
RO-1402- 0180	90	- 101	- 4,2	RO-1402- 0560	280	- 301	- 8,1
RO-1402- 0190	95	- 106	- 4,2	RO-1402- 0600	300	- 321	- 8,1

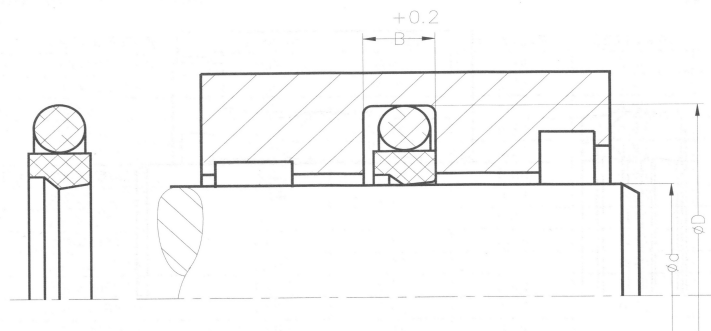

## DTH-RO-7000-PTFE-NB

## Stangendichtung / Rod Seal

Nummer:	d	D	b	Nummer:	d	D	b
RO-70000-0005	2,5	- 6,9	- 2,2	RO-70000-0084-1	42	- 57,1	- 6,3
RO-70000-0008	4	- 8,9	- 2,2	RO-70000-0090	45	- 60,1	- 6,3
RO-70000-0010	5	- 9,9	- 2,2	RO-70000-0090-1	45	- 55,7	- 4,2
RO-70000-0016	8	- 12,9	- 2,2	RO-70000-0094	47	- 57,7	- 4,2
RO-70000-0020	10	- 14,9	- 2,2	RO-70000-0096	48	- 63,1	- 6,3
RO-70000-0020-1	10	- 17,3	- 3,2	RO-70000-0096-1	48	- 58,7	- 4,2
RO-70000-0024	12	- 19,3	- 3,2	RO-70000-0100	50	- 65,1	- 6,3
RO-70000-0028	14	- 21,3	- 3,2	RO-70000-0100-1	50	- 60,7	- 4,2
RO-70000-0030	15	- 19,9	- 2,2	RO-70000-0104	52	- 62,7	- 4,2
RO-70000-0032	16	- 23,3	- 3,2	RO-70000-0104-1	52	- 67,1	- 6,3
RO-70000-0032-1	16	- 20,9	- 2,2	RO-70000-0110	55	- 70,1	- 6,3
RO-70000-0036	18	- 25,3	- 3,2	RO-70000-0110-1	55	- 65,7	- 4,2
RO-70000-0036-1	18	- 22,9	- 2,2	RO-70000-0112	56	- 71,1	- 6,3
RO-70000-0038	19	- 29,7	- 4,2	RO-70000-0112-1	56	- 66,7	- 4,2
RO-70000-0040	20	- 30,7	- 4,2	RO-70000-0120	60	- 75,1	- 6,3
RO-70000-0040-1	20	- 27,3	- 3,2	RO-70000-0120-1	60	- 70,7	- 4,2
RO-70000-0044	22	- 32,7	- 4,2	RO-70000-0126	63	- 78,1	- 6,3
RO-70000-0044-1	22	- 29,5	- 3,2	RO-70000-0126-1	63	- 73,7	- 4,2
RO-70000-0044-2	22	- 29,3	- 3,2	RO-70000-0130	65	- 80,1	- 6,3
RO-70000-0050	25	- 35,7	- 4,2	RO-70000-0130-1	65	- 75,7	- 4,2
RO-70000-0050-1	25	- 32,3	- 3,2	RO-70000-0134	67	- 82,1	- 6,3
RO-70000-0052	26	- 36,7	- 4,2	RO-70000-0136	68	- 83,1	- 6,3
RO-70000-0056	28	- 38,7	- 4,2	RO-70000-0136-1	68	- 78,7	- 4,2
RO-70000-0056-1	28	- 35,3	- 3,2	RO-70000-0140	70	- 85,1	- 6,3
RO-70000-0060	30	- 40,7	- 4,2	RO-70000-0140-1	70	- 80,7	- 4,2
RO-70000-0060-1	30	- 37,3	- 3,2	RO-70000-0146	73	- 88,1	- 6,3
RO-70000-0064	32	- 42,7	- 4,2	RO-70000-0150	75	- 90,1	- 6,3
RO-70000-0064-1	32	- 39,3	- 3,2	RO-70000-0150-1	75	- 85,7	- 4,2
RO-70000-0070	35	- 45,7	- 4,2	RO-70000-0156	78	- 93,1	- 6,3
RO-70000-0070-1	35	- 42,3	- 3,2	RO-70000-0160	80	- 95,1	- 6,3
RO-70000-0072	36	- 46,7	- 4,2	RO-70000-0160-1	80	- 90,1	- 4,2
RO-70000-0072-1	36	- 43,3	- 3,2	RO-70000-0170	85	- 100,1	- 6,3
RO-70000-0076	38	- 48,7	- 4,2	RO-70000-0180	90	- 105,1	- 6,3
RO-70000-0076-1	38	- 53,1	- 6,3	RO-70000-0184	92	- 107,1	- 6,3
RO-70000-0080	40	- 55,1	- 6,3	RO-70000-0190	95	- 110,1	- 6,3
RO-70000-0080-1	40	- 50,7	- 4,2	RO-70000-0190-1	95	- 115,1	- 8,1
RO-70000-0082	41	- 51,7	- 4,2	RO-70000-0200	100	- 115,1	- 6,3
RO-70000-0084	42	- 52,7	- 4,2	RO-70000-0200-1	100	- 110,7	- 4,2

**DTH-RO-70000-PTFE-NB****Stangendichtung / Rod Seal**

Nummer:	d	D	b	Nummer:	d	D	b
RO-70000-0210	105	- 125,5	- 8,1	RO-70000-0430	215	- 235,5	- 8,1
RO-70000-0210-1	105	- 120,1	- 6,3	RO-70000-0440	220	- 240,5	- 8,1
RO-70000-0216	108	- 123,1	- 6,3	RO-70000-0450	225	- 245,5	- 8,1
RO-70000-0220	110	- 125,1	- 6,3	RO-70000-0460	230	- 250,5	- 8,1
RO-70000-0220-1	110	- 130,5	- 8,1	RO-70000-0470	235	- 255,5	- 8,1
RO-70000-0220-2	110	- 120,7	- 4,2	RO-70000-0480	240	- 260,5	- 8,1
RO-70000-0226	113	- 128,1	- 6,3	RO-70000-0490	245	- 265,5	- 8,1
RO-70000-0230	115	- 130,1	- 6,3	RO-70000-0500	250	- 270,5	- 8,1
RO-70000-0240	120	- 135,1	- 6,3	RO-70000-0520	260	- 284	- 8,1
RO-70000-0250	125	- 140,1	- 6,3	RO-70000-0520-1	260	- 280,5	- 8,1
RO-70000-0250-1	125	- 145,5	- 8,1	RO-70000-0540	270	- 294	- 8,1
RO-70000-0254	127	- 142,1	- 6,3	RO-70000-0550	275	- 299	- 8,1
RO-70000-0260	130	- 145,1	- 6,3	RO-70000-0560	280	- 304	- 8,1
RO-70000-0260-1	130	- 150,5	- 8,1	RO-70000-0570	285	- 309	- 8,1
RO-70000-0264	132	- 147,1	- 6,3	RO-70000-0580	290	- 314	- 8,1
RO-70000-0270	135	- 150,1	- 6,3	RO-70000-0590	295	- 319	- 8,1
RO-70000-0274	137	- 152,1	- 6,3	RO-70000-0600	300	- 324	- 8,1
RO-70000-0276	138	- 153,1	- 6,3	RO-70000-0600-1	300	- 320,5	- 8,1
RO-70000-0280	140	- 155,1	- 6,3	RO-70000-0620	310	- 334	- 8,1
RO-70000-0284	142	- 157,1	- 6,3	RO-70000-0640	320	- 344	- 8,1
RO-70000-0290	145	- 160,1	- 6,3	RO-70000-0660	330	- 354	- 8,1
RO-70000-0290-1	145	- 165,5	- 8,1	RO-70000-0680	340	- 364	- 8,1
RO-70000-0294	147	- 162,1	- 6,3	RO-70000-0690	345	- 369	- 8,1
RO-70000-0300	150	- 165,1	- 6,3	RO-70000-0700	350	- 374	- 8,1
RO-70000-0300-1	150	- 170,5	- 8,1	RO-70000-0720	360	- 384	- 8,1
RO-70000-0306	153	- 168,1	- 6,3	RO-70000-0740	370	- 394	- 8,1
RO-70000-0310	155	- 170,1	- 6,3	RO-70000-0760	380	- 404	- 8,1
RO-70000-0314	157	- 172,1	- 6,3	RO-70000-0780	390	- 414	- 8,1
RO-70000-0320	160	- 175,1	- 6,3	RO-70000-0800	400	- 424	- 8,1
RO-70000-0320-1	160	- 180,5	- 8,1	RO-70000-0810	405	- 429	- 8,1
RO-70000-0330	165	- 180,1	- 6,3	RO-70000-0840	420	- 444	- 8,1
RO-70000-0340	170	- 185,1	- 6,3	RO-70000-0860	430	- 454	- 8,1
RO-70000-0340-1	170	- 190,5	- 8,1	RO-70000-0880	440	- 464	- 8,1
RO-70000-0344	172	- 187,1	- 6,3	RO-70000-0900	450	- 474	- 8,1
RO-70000-0344-1	172	- 192,5	- 8,1	RO-70000-0920	460	- 484	- 8,1
RO-70000-0350	175	- 190,1	- 6,3	RO-70000-0940	470	- 494	- 8,1
RO-70000-0354	177	- 192,1	- 6,3	RO-70000-0960	480	- 504	- 8,1
RO-70000-0360	180	- 195,1	- 6,3	RO-70000-0980	490	- 514	- 8,1
RO-70000-0360-1	180	- 200,5	- 8,1	RO-70000-1000	500	- 524	- 8,1
RO-70000-0370	185	- 200,1	- 6,3	RO-70000-1020	510	- 534	- 8,1
RO-70000-0380	190	- 205,1	- 6,3	RO-70000-1040	520	- 544	- 8,1
RO-70000-0384	192	- 207,1	- 6,3	RO-70000-1060	530	- 554	- 8,1
RO-70000-0390	195	- 210,1	- 6,3	RO-70000-1080	540	- 564	- 8,1
RO-70000-0400	200	- 220,5	- 8,1	RO-70000-1100	550	- 574	- 8,1
RO-70000-0220	210	- 230,5	- 8,1	RO-70000-1140	570	- 594	- 8,1
RO-70000-0424	212	- 232,5	- 8,1				

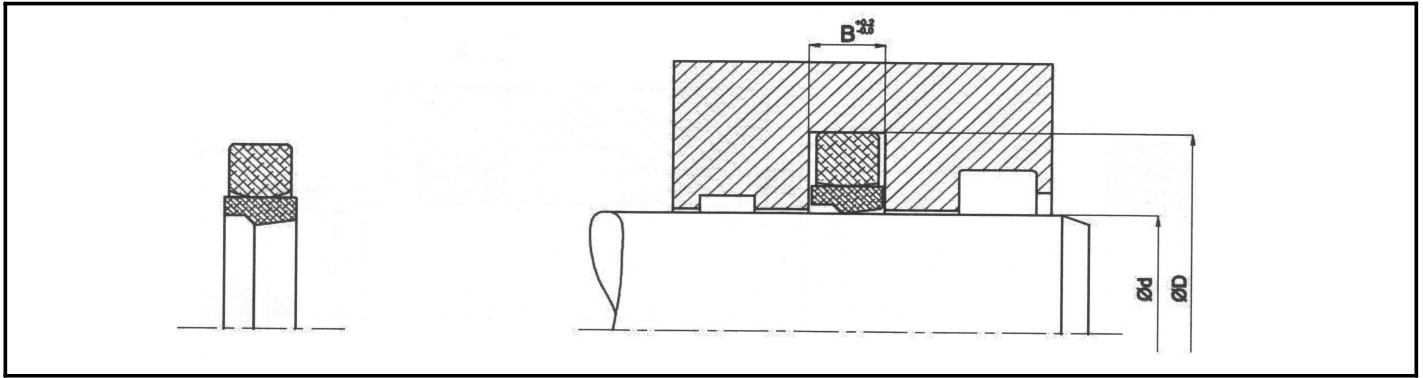

### DTH-RO-1408-PTFE-NB

### Stangendichtung / Rod Seal

Nummer:	d	D	b	Nummer:	d	D	b
RO-1408- 0310	155	- 175	- 10	RO-1408- 0830	415	- 445	- 15
RO-1408- 0560	280	- 305	- 12,5	RO-1408- 0950	475	- 505	- 15
RO-1408- 0600	300	- 325	- 12,5	RO-1408- 1040	570	- 605	- 17,5
RO-1408- 0660	330	- 360	- 15				

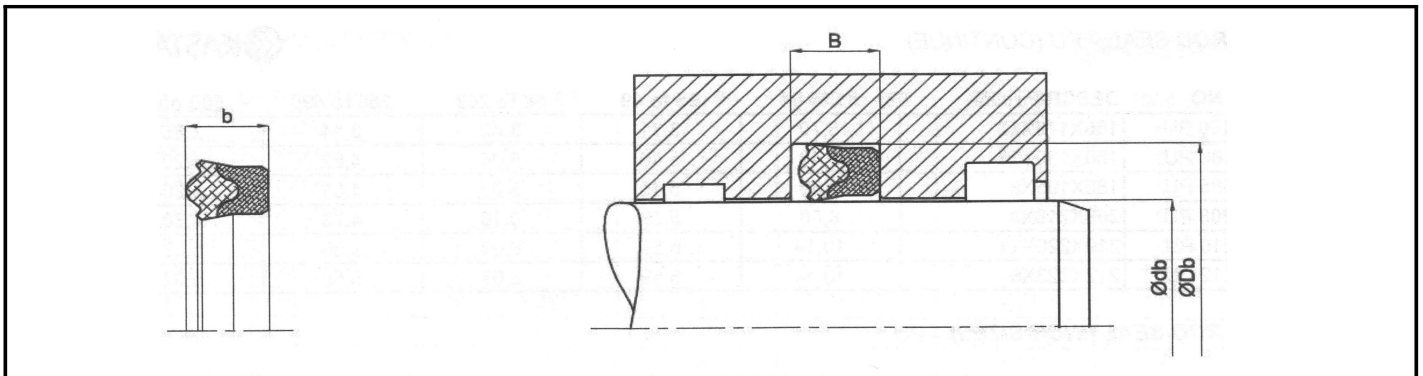

### DTH-RO-78000-NB-FA

### Stangendichtung / Rod Seal

Nummer:	d	D	b	Nummer:	d	D	b
RO-78000-0050	25	- 33	- 6,3	RO-78000-0090	45	- 55	- 8
RO-78000-0056	28	- 36	- 6,3	RO-78000-0100	50	- 60	- 8
RO-78000-0060	30	- 38	- 6,3	RO-78000-0110	55	- 65	- 8
RO-78000-0070	35	- 43	- 6,3	RO-78000-0120	60	- 70	- 8
RO-78000-0080	40	- 48	- 6,3	RO-78000-0130	65	- 77	- 9,5

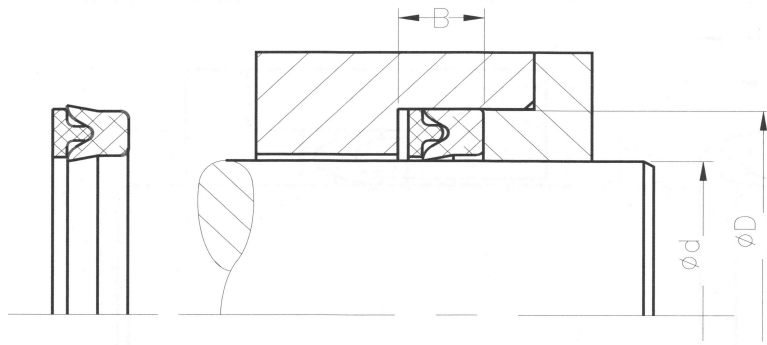

**DTH-RO-302000-NB-FAB-POM-PTFE**

**Hochdruck Nutringsatz / High Pressure Chevron Seal**

Nummer:	d	D	b	Nummer:	d	D	b
RO-302000- 0028	14	- 24	- 7	RO-302000- 0040-2	20	- 32	- 8
RO-302000- 0030	15	- 24	- 7	RO-302000- 0044	22	- 32	- 8
RO-302000- 0032	16	- 26	- 7	RO-302000- 0044-1	22,2	- 32	- 8
RO-302000- 0036	18	- 28	- 8	RO-302000- 0048	24	- 34	- 8
RO-302000- 0036-1	18	- 28	- 6,2	RO-302000- 0050	25	- 35	- 8
RO-302000- 0040	20	- 30	- 8	RO-302000- 0056	28	- 38	- 8
RO-302000- 0040-1	20	- 35	- 7				

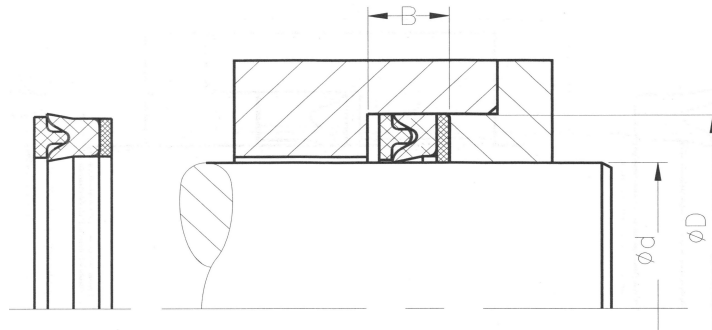

**DTH-RO-302000B-NB-FAB-POM-PTFE**

**Hochdruck Nutringsatz / High Pressure Chevron Seal**

Nummer:	d	D	b	Nummer:	d	D	b
RO-302000B- 0028	14	- 24	- 9	RO-302000B- 0044	22	- 32	- 10
RO-302000B- 0030	15	- 24	- 8,5	RO-302000B- 0048	24	- 34	- 10
RO-302000B- 0032	16	- 26	- 9	RO-302000B- 0050	25	- 35	- 10
RO-302000B- 0036	18	- 28	- 10	RO-302000B- 0056	28	- 38	- 10
RO-302000B- 0040	20	- 30	- 10				

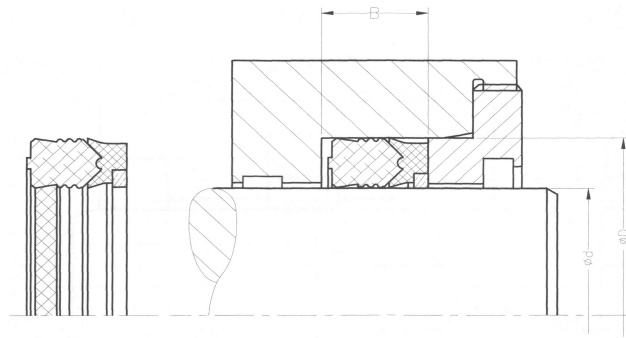

**DTH-RO-68000-NB-FA-TP-PO**

**Stangendichtungssatz / Rod Seal**

Nummer:	d	D	b	Nummer:	d	D	b
RO-68000-0060	30	- 43	- 20	RO-68000-0180	90	- 110	- 30
RO-68000-0064	32	- 47	- 22,5	RO-68000-0200	100	- 120	- 30
RO-68000-0070	35	- 47	- 22,5	RO-68000-0220	110	- 130	- 32,5
RO-68000-0080	40	- 55	- 22,5	RO-68000-0228	114	- 130	- 19
RO-68000-0090	45	- 60	- 22,5	RO-68000-0230	115	- 130	- 30
RO-68000-0100	50	- 65	- 22,5	RO-68000-0230-1	115	- 125	- 22,5
RO-68000-0100-1	50	- 65	- 24,5	RO-68000-0240	120	- 140	- 30
RO-68000-0110	55	- 70	- 22,5	RO-68000-0250	125	- 145	- 29,6
RO-68000-0120	60	- 75	- 22,5	RO-68000-0280	140	- 155	- 22,5
RO-68000-0140	70	- 85	- 22,5	RO-68000-0280-1	140	- 160	- 30
RO-68000-0140-1	70	- 90	- 30	RO-68000-0320	160	- 180	- 28
RO-68000-0160	80	- 95	- 22,5	RO-68000-0360	180	- 205	- 35
RO-68000-0170	85	- 95	- 22,5	RO-68000-0440	220	- 240	- 22,5
RO-68000-0160	80	- 100	- 30	RO-68000-0440-1	220	- 245	- 35



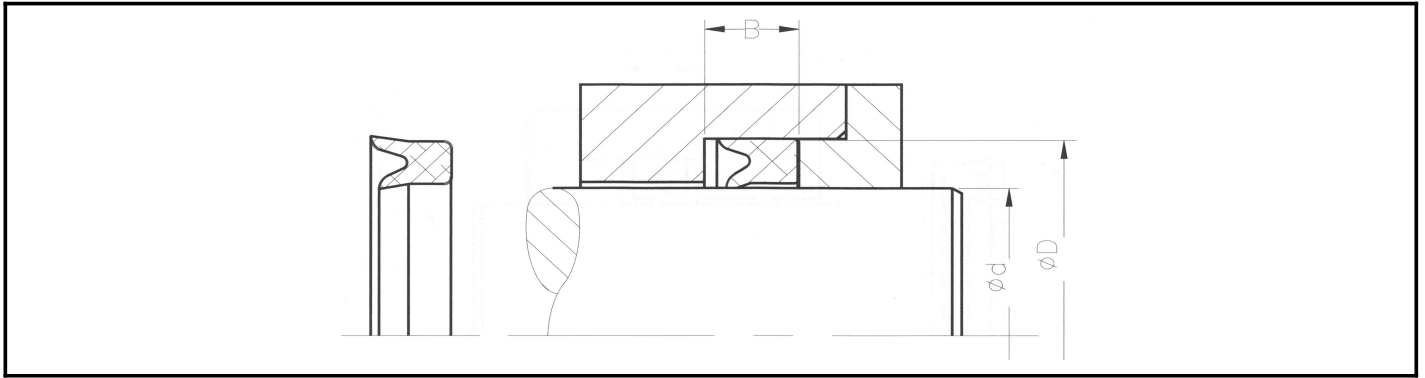

### DTH-RO-304000-NB-FAB

### Niederdruck Nutring / Low Pressure Chevron Seal

Nummer:	d	D	b	Nummer:	d	D	b
RO-304000- 0024	12	- 20	- 5,8	RO-304000- 0036-3	18	- 26	- 4,5
RO-304000- 0024-1	12	- 20	- 5,6	RO-304000- 0040	20	- 28	- 6
RO-304000- 0026	13	- 20	- 4,5	RO-304000- 0044	22	- 30	- 6
RO-304000- 0028	14	- 22	- 6	RO-304000- 0044-1	22	- 30	- 5
RO-304000- 0028-1	14	- 22	- 5,3	RO-304000- 0048	24	- 32	- 5,8
RO-304000- 0032	16	- 24	- 6	RO-304000- 0048-1	24	- 34	- 5,3
RO-304000- 0032-1	16	- 24	- 5,8	RO-304000- 0050	25	- 33	- 4,5
RO-304000- 0032-2	16	- 24	- 5,2	RO-304000- 0052	26	- 32	- 6,7
RO-304000- 0036	18	- 26	- 6	RO-304000- 0052-1	26	- 33	- 4,3
RO-304000- 0036-1	18	- 26	- 5,4	RO-304000- 0084	42	- 50	- 6
RO-304000- 0036-2	18	- 25	- 4,5				

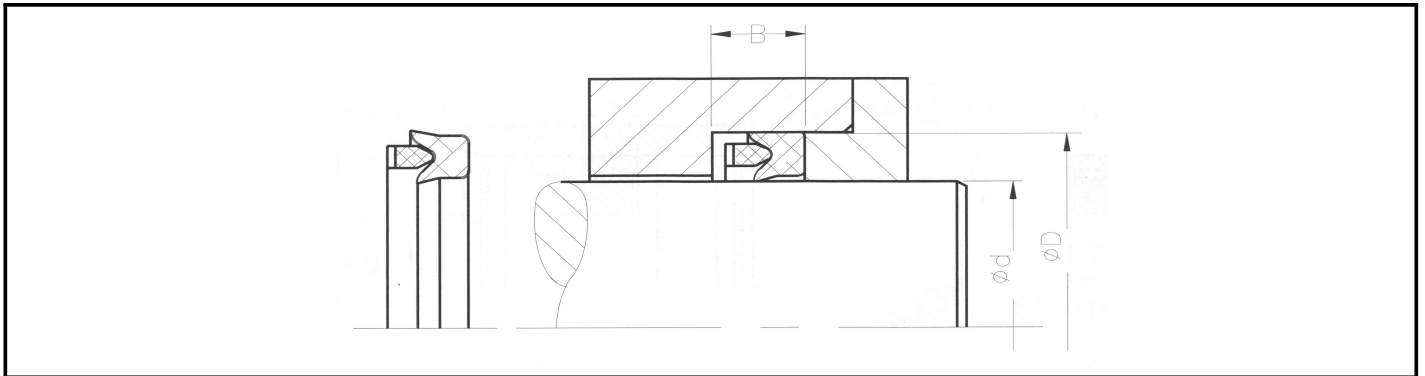

### DTH-RO-306000-NB-FAB-POM

### Niederdruck Nutring / Low Pressure Chevron Seal

Nummer:	d	D	b	Nummer:	d	D	b
RO-306000- 0024	12	- 20	- 6	RO-306000- 0044	22	- 30	- 7
RO-306000- 0028	14	- 22	- 7	RO-306000- 0048	24	- 32	- 6,3

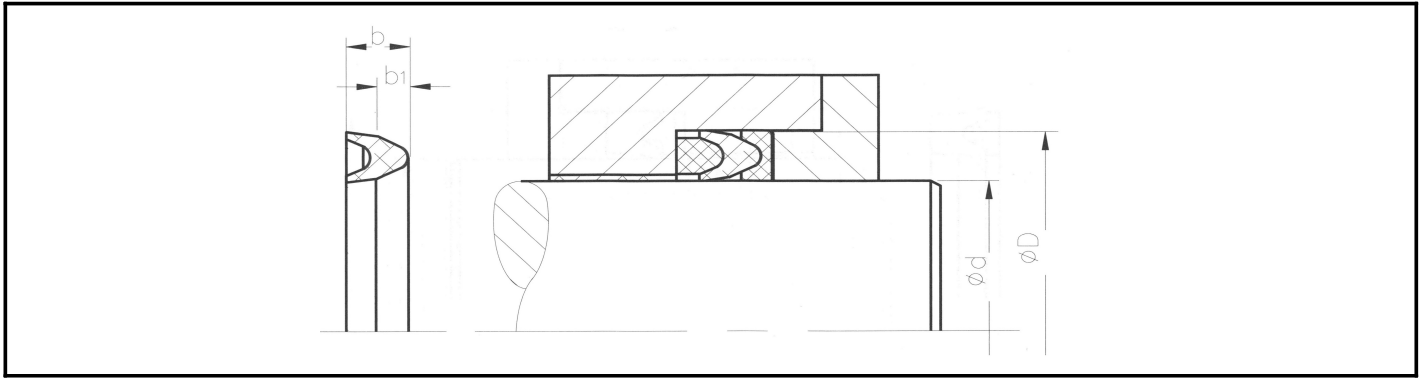

**DTH-RO-300000-NB-FAB**

**Dachmanschette / Chevron Ring**

Nummer:	d	D	b	Nummer:	d	D	b
RO-300000- 0050	25	- 15	- 5/3	RO-300000- 0074	37	- 25	- 6,7/3,6
RO-300000- 0052	26	- 18	- 5/3	RO-300000- 0076	38	- 22	- 8,5/3,5
RO-300000- 0056	28	- 15	- 6,5/4	RO-300000- 0076-1	38	- 25	- 7/4,6
RO-300000- 0056-1	28	- 18	- 5,5/3,5	RO-300000- 0076-2	38	- 28	- 6,1/4,1
RO-300000- 0056-2	28	- 18	- 6/4	RO-300000- 0090	45	- 30	- 7,5/4,5
RO-300000- 0060	30	- 15	- 7,5/4,5	RO-300000- 0096	48	- 36	- 6/3,5
RO-300000- 0060-1	30	- 16	- 7/4	RO-300000- 0096-1	48	- 38	- 6/3,5
RO-300000- 0060-2	30	- 18	- 6/3,5	RO-300000- 0112	56	- 36	- 10/6
RO-300000- 0060-3	30	- 20	- 5,5/3,3	RO-300000- 0120	60	- 45	- 7,5/4,5
RO-300000- 0064	32	- 18	- 7,1/4,6	RO-300000- 0120-1	60	- 50	- 5,5/3,5
RO-300000- 0064-1	32	- 20	- 6,7/4,5	RO-300000- 0130	65	- 50	- 7,5/4,5
RO-300000- 0064-2	32	- 22	- 5,7/3,3	RO-300000- 0130-1	65	- 55	- 5,5/3,5
RO-300000- 0070	35	- 20	- 7,5/4,5	RO-300000- 0140	70	- 55	- 7,5/4,5
RO-300000- 0070-1	35	- 22	- 7/4,5	RO-300000- 0152	76	- 60	- 8/5
RO-300000- 0070-2	35	- 24	- 6/4	RO-300000- 0160	80	- 65	- 7,5/4,5
RO-300000- 0070-3	35	- 25	- 5,5/3,3				

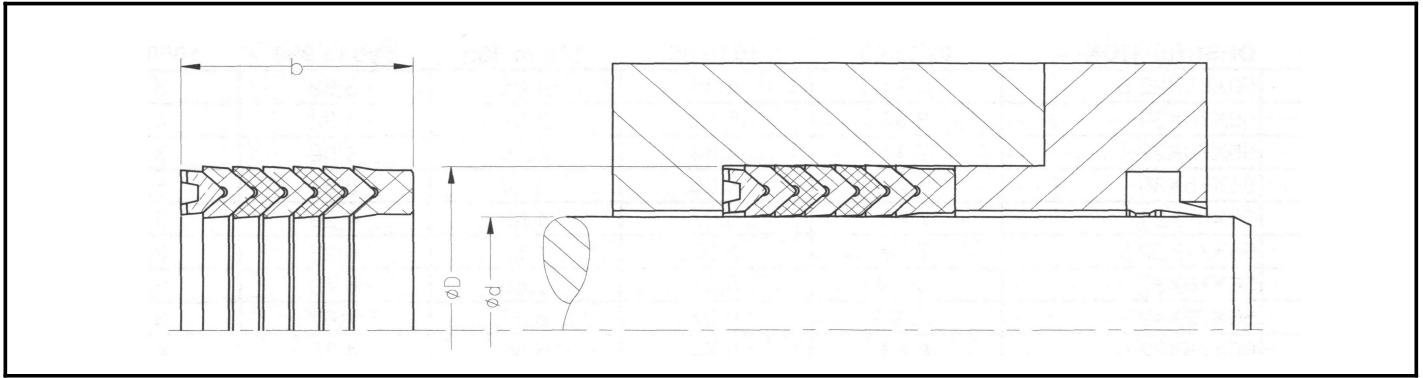

**DTH-RO-2000-NB-FA-POM**

**Stangen-Dachmanschettensatz / Rod Packing**

Nummer:	d	D	b	Nummer:	d	D	b
R0-2000 - 0016	8	- 18	- 18,5	R0-2000 - 0096	48	- 63	- 22,5
R0-2000 - 0020	10	- 20	- 18,5	R0-2000 - 0100	50	- 65	- 22,5
R0-2000 - 0024	12	- 22	- 18,5	R0-2000 - 0100-1	50	- 70	- 30
R0-2000 - 0026	13,5	- 25	- 16,5	R0-2000 - 0110	55	- 70	- 22,5
R0-2000 - 0028	14	- 24	- 18,5	R0-2000 - 0110-1	55	- 75	- 30
R0-2000 - 0030	15	- 25	- 18,5	R0-2000 - 0110-2	55	- 67	- 24
R0-2000 - 0030-1	15	- 32	- 25	R0-2000 - 0112	56	- 71	- 22,5
R0-2000 - 0032	16	- 26	- 18,5	R0-2000 - 0112-1	56	- 76	- 37
R0-2000 - 0036	18	- 28	- 18,5	R0-2000 - 0112-2	56	- 72	- 49
R0-2000 - 0036-1	18	- 32	- 23,5	R0-2000 - 0120	60	- 75	- 22,5
R0-2000 - 0040	20	- 30	- 18,5	R0-2000 - 0120-1	60	- 80	- 37
R0-2000 - 0040-1	20	- 32	- 22,5	R0-2000 - 0120-3	60	- 85	- 37
R0-2000 - 0044	22	- 32	- 18,5	R0-2000 - 0126	63	- 78	- 22,5
R0-2000 - 0044-1	22	- 34	- 22,5	R0-2000 - 0126-1	63	- 83	- 37
R0-2000 - 0050	25	- 37	- 22,5	R0-2000 - 0126-2	63,5	- 78	- 40
R0-2000 - 0050-1	25	- 40	- 22,5	R0-2000 - 0130	65	- 80	- 22,5
R0-2000 - 0056	28	- 40	- 22,5	R0-2000 - 0130-1	65	- 85	- 40
R0-2000 - 0056-1	28	- 43	- 22,5	R0-2000 - 0140	70	- 85	- 22,5
R0-2000 - 0060	30	- 42	- 22,5	R0-2000 - 0140-1	70	- 90	- 40
R0-2000 - 0060-1	30	- 45	- 22,5	R0-2000 - 0150	75	- 90	- 22,5
R0-2000 - 0030-2	30	- 50	- 37	R0-2000 - 0150-1	75	- 95	- 40
R0-2000 - 0064	32	- 44	- 22,5	R0-2000 - 0150-2	75	- 87	- 25
R0-2000 - 0064-1	32	- 47	- 22,5	R0-2000 - 0170-2	85	- 95	- 22,5
R0-2000 - 0070	35	- 47	- 22,5	R0-2000 - 0150-3	75	- 100	- 34
R0-2000 - 0070-1	35	- 50	- 22,5	R0-2000 - 0156	78	- 100	- 35
R0-2000 - 0072	36	- 48	- 22,5	R0-2000 - 0160	80	- 95	- 22,5
R0-2000 - 0072-1	36	- 51	- 22,5	R0-2000 - 0160-1	80	- 100	- 40
R0-2000 - 0080	40	- 52	- 22,5	R0-2000 - 0170	85	- 100	- 22,5
R0-2000 - 0080-1	40	- 55	- 22,5	R0-2000 - 0170-1	85	- 105	- 40
R0-2000 - 0040-3	40	- 56	- 22,5	R0-2000 - 0180	90	- 105	- 22,5
R0-2000 - 0040-2	40	- 55	- 25	R0-2000 - 0180-3	90	- 110	- 22,5
R0-2000 - 0084	42	- 54	- 22,5	R0-2000 - 0180-1	90	- 110	- 40
R0-2000 - 0084-1	42	- 57	- 22,5	R0-2000 - 0180-2	90	- 110	- 26
R0-2000 - 0090	45	- 60	- 22,5	R0-2000 - 0190	95	- 120	- 50
R0-2000 - 0090-1	45	- 65	- 22,5	R0-2000 - 0200	100	- 115	- 30
R0-2000 - 0090-2	45	- 55	- 22	R0-2000 - 0200-1	100	- 120	- 40
R0-2000 - 0090-3	45	- 62	- 26	R0-2000 - 0210	105	- 120	- 30
R0-2000 - 0094	47	- 65	- 33	R0-2000 - 0210-1	105	- 125	- 40

**DTH-R0-2000-NB-FA-POM****Stangen-Dachmanschettensatz / Rod Packing**

Nummer:	d	D	b	Nummer:	d	D	b
R0-2000 - 0210-2	105	- 130	- 40	R0-2000 - 400	200	- 220	- 40
R0-2000 - 0220	110	- 125	- 30	R0-2000 - 400-1	200	- 230	- 60
R0-2000 - 230-1	115	- 140	- 46	R0-2000 - 410	210	- 240	- 50
R0-2000 - 230-2	115	- 135	- 30	R0-2000 - 430	215	- 245	- 41
R0-2000 - 240	120	- 140	- 49	R0-2000 - 460	230	- 260	- 58
R0-2000 - 204-1	120	- 145	- 46	R0-2000 - 480	240	- 270	- 60
R0-2000 - 250	125	- 140	- 34	R0-2000 - 480-1	240	- 260	- 46
R0-2000 - 250-1	125	- 150	- 46	R0-2000 - 500	250	- 270	- 42
R0-2000 - 260	130	- 155	- 42,5	R0-2000 - 520	260	- 290	- 60
R0-2000 - 270	135	- 160	- 55	R0-2000 - 580	290	- 320	- 35
R0-2000 - 270-1	135	- 160	- 40	R0-2000 - 600	300	- 330	- 60
R0-2000 - 280	140	- 155	- 34	R0-2000 - 620	310	- 340	- 60
R0-2000 - 280-1	140	- 165	- 46	R0-2000 - 640	320	- 350	- 60
R0-2000 - 280-2	140	- 160	- 32	R0-2000 - 640-1	320	- 360	- 46
R0-2000 - 300	150	- 170	- 40	R0-2000 - 660	330	- 360	- 60
R0-2000 - 300-1	150	- 180	- 60	R0-2000 - 720	360	- 390	- 60
R0-2000 - 320	160	- 180	- 40	R0-2000 - 720-1	360	- 400	- 55
R0-2000 - 320-1	160	- 190	- 60	R0-2000 - 740	370	- 400	- 55
R0-2000 - 320-2	160	- 175	- 34	R0-2000 - 800	400	- 440	- 65
R0-2000 - 330	165	- 195	- 50,5	R0-2000 - 800-1	400	- 430	- 46
R0-2000 - 340	170	- 190	- 40	R0-2000 - 820	420	- 460	- 80
R0-2000 - 360	180	- 200	- 40	R0-2000 - 880	440	- 480	- 68
R0-2000 - 360-1	180	- 210	- 60	R0-2000 - 900	450	- 490	- 65
R0-2000 - 380	190	- 220	- 42				

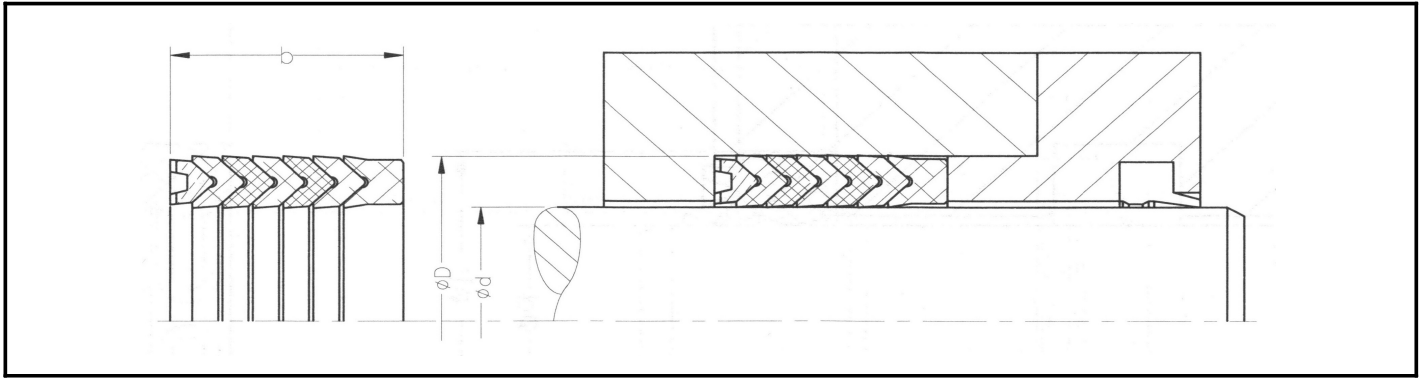

**DTH-RO-8000-NB-FA-POM**

**Stangen-Dachmanschettensatz / Rod Packing**

Nummer:	d	D	b	Nummer:	d	D	b
R0-8000 - 0024	12,7	- 25,4	- 19,05	R0-8000 - 0126-2	63,5	- 79,37	- 28,5
R0-8000 - 0038	19,05	- 28,5	- 17,46	R0-8000 - 0126-3	63,5	- 82,55	- 28,5
R0-8000 - 0040	20,62	- 33,32	- 33,32	R0-8000 - 0138	69,85	- 88,9	- 31,75
R0-8000 - 0044	22,22	- 34,92	- 19,05	R0-8000 - 0152	76,2	- 88,9	- 25,4
R0-8000 - 0062	31,75	- 44,45	- 25,4	R0-8000 - 0152-1	76,2	- 95,25	- 31,75
R0-8000 - 0076	38,1	- 50,8	- 25,4	R0-8000 - 0152-2	76,2	- 101,6	- 38,1
R0-8000 - 0076-1	38,1	- 53,98	- 25,4	R0-8000 - 0164	82,55	- 101,6	- 31,75
R0-8000 - 0088	44,45	- 57,15	- 25,4	R0-8000 - 0176	88,9	- 104,8	- 28,5
R0-8000 - 0088-1	44,45	- 63,5	- 38,1	R0-8000 - 0176-1	88,9	- 107,95	- 30,16
R0-8000 - 0088-2	44,45	- 69,85	- 50,8	R0-8000 - 0176-2	88,9	- 114,3	- 38,1
R0-8000 - 0100	50,8	- 63,5	- 25,4	R0-8000 - 0190	95,25	- 114,3	- 30,16
R0-8000 - 0100-1	50,8	- 65	- 25,4	R0-8000 - 0202	101,6	- 127	- 38,1
R0-8000 - 0100-2	50,8	- 66,67	- 25,4	R0-8000 - 0217	107,95	- 127	- 31,75
R0-8000 - 0100-3	50,8	- 69,85	- 25,4	R0-8000 - 0214-1	107,95	- 130,18	- 38,1
R0-8000 - 0106	53,98	- 69,85	- 28,5	R0-8000 - 0228	114,3	- 133,36	- 31,75
R0-8000 - 0114	57,16	- 76,2	- 25,4	R0-8000 - 0228-1	114,3	- 139,7	- 38,1
R0-8000 - 0126	63,5	- 76,2	- 28,5	R0-8000 - 0154	127	- 158,75	- 60
R0-8000 - 0126-1	63,5	- 78	- 41	R0-8000 - 0418	209,55	- 228,6	- 38,1

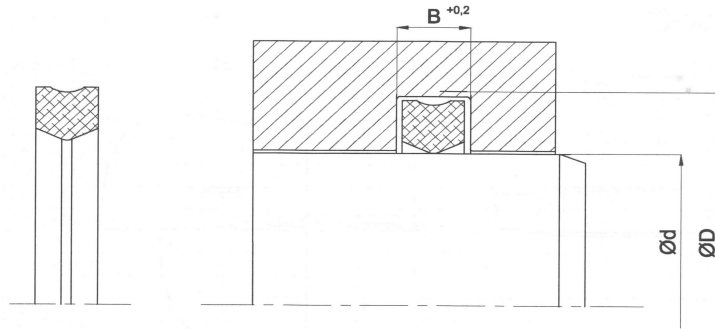

## DTH-COV-166000-PU

## Cover Dichtung / Cover Seal

Nummer:	d	D	b	Nummer:	d	D	b
COV-166000- 0040	20	- 24	- 4,8	COV-166000- 0160	80	- 90	- 10,5
COV-166000- 0040-1	20,5	- 25	- 4	COV-166000- 0180	90	- 110	- 12,3
COV-166000- 0040-2	20	- 25	- 5,3	COV-166000- 0200	100	- 105,6	- 6,2
COV-166000- 0050	25	- 29,2	- 5	COV-166000- 0210	105	- 112,8	- 5,8
COV-166000- 0060	30	- 34	- 4,8	COV-166000- 0218	109	- 114,6	- 6,2
COV-166000- 0070	35	- 39,5	- 4,5	COV-166000- 0220	110	- 117	- 4,7
COV-166000- 0080	40	- 46	- 3	COV-166000- 0234	117	- 122,6	- 6,2
COV-166000- 0100	50	- 58	- 6,4	COV-166000- 0240	120	- 140	- 12,3
COV-166000- 0110	55	- 60,4	- 6,2	COV-166000- 0244	122	- 127,6	- 6,2
COV-166000- 0120	60	- 65,5	- 5,2	COV-166000- 0294	147	- 152,6	- 6,2
COV-166000- 0140	70	- 75,6	- 6,2	COV-166000- 0324	162	- 167,6	- 6,2

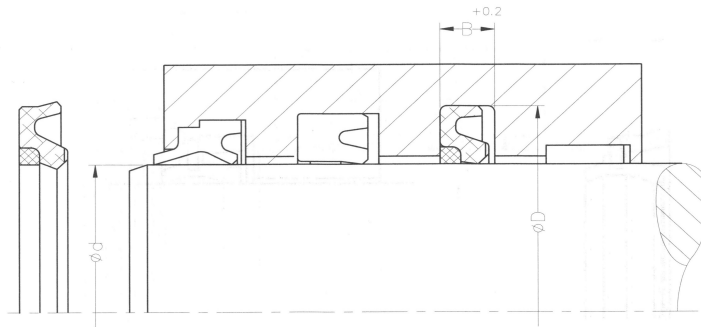

## DTH-RO-58000-PU

## Pufferdichtung / Buffer Seal

Nummer:	d	D	b	Nummer:	d	D	b
RO-580000072	36	- 46,7	- 4,2	RO-580000170	85	- 100,5	- 6,3
RO-580000076	38	- 48,7	- 4,2	RO-580000180	90	- 105,5	- 6,3
RO-580000080	40	- 55,5	- 6,3	RO-580000190	95	- 110,5	- 6,3
RO-580000090	45	- 60,5	- 6,3	RO-580000200	100	- 115,5	- 6,3
RO-580000100	50	- 65,5	- 6,3	RO-580000210	105	- 120,5	- 6,3
RO-580000110	55	- 70,5	- 6,3	RO-580000220	110	- 125,5	- 6,3
RO-580000112	56	- 71,1	- 6,3	RO-580000230	115	- 130,5	- 6,3
RO-580000120	60	- 75,5	- 6,3	RO-580000240	120	- 135,5	- 6,3
RO-580000130	65	- 80,5	- 6,3	RO-580000250	125	- 140,5	- 6,3
RO-580000140	70	- 85,5	- 6,3	RO-580000260	130	- 145,5	- 6,3
RO-580000150	75	- 90,5	- 6,3	RO-580000280	140	- 155,5	- 6,3
RO-580000160	80	- 95,5	- 6,3	RO-580000300	150	- 165,5	- 6,3

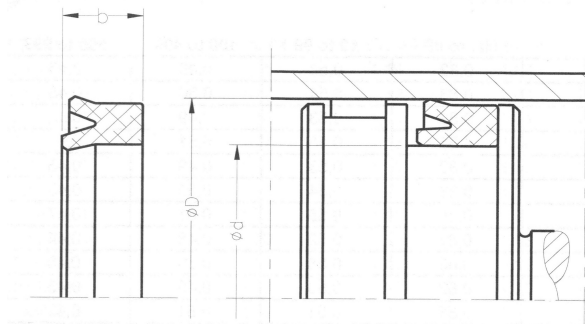

## DTH-PI-46000-NB

## Kolbendichtung / Piston Seal

Nummer:	d	D	b	Nummer:	d	D	b
PI-46000-NB 0012-1	6	- 2,5	- 4,5	PI-46000-NB 0064-2	32	- 22	- 5
PI-46000-NB 0014	7,5	- 4	- 2	PI-46000-NB 0070	35	- 25	- 6,5
PI-46000-NB 0018	9	- 4	- 3,5	PI-46000-NB 0070-1	35	- 25	- 7
PI-46000-NB 0018-1	9	- 4	- 6	PI-46000-NB 0070-2	35	- 27	- 10
PI-46000-NB 0024	12	- 7	- 2,55	PI-46000-NB 0070-3	35	- 25	- 8
PI-46000-NB 0024-1	12,5	- 4,5	- 4	PI-46000-NB 0070-4	35	- 20	- 10
PI-46000-NB 0024-3	12	- 5	- 7	PI-46000-NB 0072	36	- 28	- 7
PI-46000-NB 0028	14	- 6	- 8	PI-46000-NB 0072-2	36	- 24	- 6
PI-46000-NB 0028-1	14	- 8	- 4,5	PI-46000-NB 0076-1	38	- 28	- 7
PI-46000-NB 0028-3	14	- 6	- 6	PI-46000-NB 0078	39	- 32	- 5
PI-46000-NB 0030	15	- 9	- 8	PI-46000-NB 0080-2	40	- 30	- 7
PI-46000-NB 0032	16	- 6	- 10	PI-46000-NB 0080-3	40	- 30	- 6
PI-46000-NB 0032-1	16	- 10	- 4	PI-46000-NB 0080-4	40	- 28	- 10
PI-46000-NB 0032-2	16	- 10	- 5,5	PI-46000-NB 0080-5	40	- 28	- 9
PI-46000-NB 0032-3	16	- 9	- 5,5	PI-46000-NB 0080-6	40	- 30	- 5
PI-46000-NB 0032-4	16	- 10	- 8	PI-46000-NB 0080-7	40	- 32	- 5,5
PI-46000-NB 0032-5	16	- 8	- 5,5	PI-46000-NB 0080-8	40	- 32	- 3,25
PI-46000-NB 0032-6	16	- 10	- 2,55	PI-46000-NB 0086	43	- 35	- 9
PI-46000-NB 0040	20	- 14	- 5,5	PI-46000-NB 0086-1	43	- 38	- 3,8
PI-46000-NB 0040-1	20	- 14	- 4,2	PI-46000-NB 0090	45	- 38	- 6
PI-46000-NB 0040-2	20	- 14	- 2,7	PI-46000-NB 0090-1	45	- 37	- 7
PI-46000-NB 0040-3	20	- 12	- 5,5	PI-46000-NB 0090-2	45	- 35	- 6
PI-46000-NB 0044-1	22	- 10	- 8	PI-46000-NB 0100-3	50	- 40	- 7
PI-46000-NB 0044-3	22	- 16	- 5,5	PI-46000-NB 0100-4	50	- 40	- 5
PI-46000-NB 0044-4	22	- 16	- 4	PI-46000-NB 0100-5	50	- 38	- 6
PI-46000-NB 0050-1	25	- 18	- 5	PI-46000-NB 0100-6	50	- 42	- 10
PI-46000-NB 0050-2	25	- 19	- 3	PI-46000-NB 0100-8	50	- 40	- 6
PI-46000-NB 0050-3	25	- 19	- 6	PI-46000-NB 0104	52	- 42	- 5
PI-46000-NB 0050-5	25	- 15	- 5	PI-46000-NB 0110	55	- 45	- 7
PI-46000-NB 0050-6	25	- 17	- 5,5	PI-46000-NB 0110-1	55	- 45	- 10
PI-46000-NB 0052	26	- 18	- 7	PI-46000-NB 0110-2	55	- 45	- 7,5
PI-46000-NB 0052-2	26	- 18	- 5,5	PI-46000-NB 0112	56	- 46	- 7
PI-46000-NB 0056	28	- 16	- 9	PI-46000-NB 0120-1	60	- 44	- 12
PI-46000-NB 0060	30	- 22	- 6	PI-46000-NB 0120-2	60	- 50	- 10
PI-46000-NB 0060-1	30	- 20	- 7	PI-46000-NB 0120-3	60	- 50	- 7
PI-46000-NB 0060-2	30	- 15	- 10	PI-46000-NB 0120-4	60	- 50	- 7,3
PI-46000-NB 0064	32	- 24	- 5,5	PI-46000-NB 0124-1	62	- 52	- 7
PI-46000-NB 0064-1	32	- 22	- 7	PI-46000-NB 0126	63	- 53	- 6



**DTH-PI-46000-NB****Kolbendichtung / Piston Seal**

Nummer:	d	D	b	Nummer:	d	D	b
PI-46000-NB 0126-1	63	- 53	- 4,25	PI-46000-NB 0220-1	110	- 90	- 15
PI-46000-NB 0126-2	63	- 50	- 10	PI-46000-NB 0240	120	- 105	- 10
PI-46000-NB 0126-3	63	- 53	- 7	PI-46000-NB 0250	125	- 105	- 12
PI-46000-NB 0126-8	63	- 48	- 12	PI-46000-NB 0250-1	125	- 105	- 16
PI-46000-NB 0130	65	- 55	- 7	PI-46000-NB 0250-3	125	- 110	- 10
PI-46000-NB 0140-1	70	- 50	- 14	PI-46000-NB 0250-5	125	- 115	- 7,2
PI-46000-NB 0140-2	70	- 60	- 10	PI-46000-NB 0250-6	125	- 105	- 15
PI-46000-NB 0170-3	70	- 58	- 8,5	PI-46000-NB 0260	130	- 110	- 12
PI-46000-NB 0140-4	70	- 62	- 8	PI-46000-NB 0280	140	- 120	- 16
PI-46000-NB 0140-5	70	- 60	- 7	PI-46000-NB 0280-4	140	- 125	- 10
PI-46000-NB 0150	75	- 65	- 7,5	PI-46000-NB 0280-5	140	- 120	- 14
PI-46000-NB 0150-1	75	- 63	- 8,5	PI-46000-NB 0290	145	- 130	- 10
PI-46000-NB 0160-10	80	- 65	- 10	PI-46000-NB 0300	150	- 135	- 8
PI-46000-NB 0160-3	80	- 68	- 8,5	PI-46000-NB 0320	160	- 140	- 14
PI-46000-NB 0160-6	80	- 72	- 12	PI-46000-NB 0320-1	160	- 145	- 14
PI-46000-NB 0160-7	80	- 64	- 8	PI-46000-NB 0320-3	160	- 145	- 10
PI-46000-NB 0166	83	- 71,9	- 7,5	PI-46000-NB 0340	170	- 148	- 15
PI-46000-NB 0170	85	- 73	- 8,5	PI-46000-NB 0350	175	- 155	- 14
PI-46000-NB 0180	90	- 78	- 8,5	PI-46000-NB 0360	180	- 160	- 9
PI-46000-NB 0200	100	- 85	- 9	PI-46000-NB 0360-1	180	- 160	- 14
PI-46000-NB 0200-1	100	- 90	- 8,5	PI-46000-NB 0380-1	190	- 170	- 14
PI-46000-NB 0200-3	100	- 88	- 8,5	PI-46000-NB 0400	200	- 175	- 16
PI-46000-NB 0200-4	100	- 84	- 8	PI-46000-NB 0400-1	200	- 180	- 14
PI-46000-NB 0200-6	100	- 90	- 7,2	PI-46000-NB 0400-2	200	- 180	- 13,6
PI-46000-NB 0200-7	100	- 85	- 12	PI-46000-NB 0440-1	220	- 200	- 14
PI-46000-NB 0200-8	100	- 90	- 6,5	PI-46000-NB 0500	250	- 230	- 14
PI-46000-NB 0200-9	100	- 90	- 4,3	PI-46000-NB 0600	300	- 270	- 12
PI-46000-NB 0210	105	- 94	- 8	PI-46000-NB 0660	330	- 310	- 12
PI-46000-NB 0220	110	- 95	- 10	PI-46000-NB 0720	360	- 330	- 20

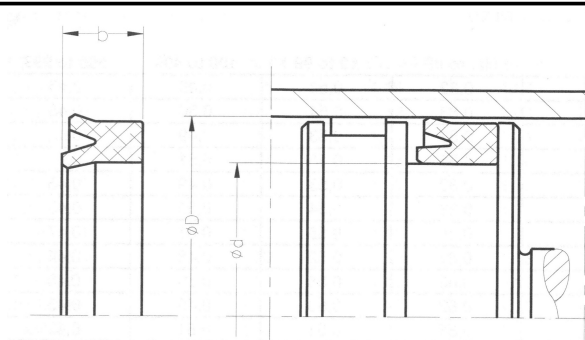

## DTH-PI-46000-PU

## Kolbendichtung / Piston Seal

Nummer:	d	D	b	Nummer:	d	D	b
PI-46000-PU 0024-1	12,5	- 4,5	- 4	PI-46000-PU 0076-1	38	- 28	- 7
PI-46000-PU 0028	14	- 6	- 8	PI-46000-PU 0078	39	- 32	- 5
PI-46000-PU 0028-1	14	- 8	- 4,5	PI-46000-PU 0080-2	40	- 30	- 7
PI-46000-PU 0028-3	14	- 6	- 6	PI-46000-PU 0080-3	40	- 30	- 6
PI-46000-PU 0030	15	- 9	- 8	PI-46000-PU 0080-4	40	- 28	- 10
PI-46000-PU 0032	16	- 6	- 10	PI-46000-PU 0080-5	40	- 28	- 9
PI-46000-PU 0032-1	16	- 10	- 4	PI-46000-PU 0080-6	40	- 30	- 5
PI-46000-PU 0032-2	16	- 10	- 5,5	PI-46000-PU 0080-7	40	- 32	- 5,5
PI-46000-PU 0032-3	16	- 9	- 5,5	PI-46000-PU 0080-8	40	- 32	- 3,25
PI-46000-PU 0032-4	16	- 10	- 8	PI-46000-PU 0086	43	- 35	- 9
PI-46000-PU 0032-5	16	- 8	- 5,5	PI-46000-PU 0086-1	43	- 38	- 3,8
PI-46000-PU 0040	20	- 14	- 5,5	PI-46000-PU 0090	45	- 38	- 6
PI-46000-PU 0040-1	20	- 14	- 4,2	PI-46000-PU 0090-1	45	- 37	- 7
PI-46000-PU 0040-3	20	- 12	- 5,5	PI-46000-PU 0090-2	45	- 35	- 6
PI-46000-PU 0044	22	- 13	- 7	PI-46000-PU 0100-3	50	- 40	- 7
PI-46000-PU 0044-1	22	- 10	- 8	PI-46000-PU 0100-4	50	- 40	- 5
PI-46000-PU 0044-3	22	- 16	- 5,5	PI-46000-PU 0100-5	50	- 38	- 6
PI-46000-PU 0044-4	22	- 16	- 4	PI-46000-PU 0100-6	50	- 42	- 10
PI-46000-PU 0050-2	25	- 19	- 3	PI-46000-PU 0100-8	50	- 40	- 6
PI-46000-PU 0050-3	25	- 19	- 6	PI-46000-PU 0104	52	- 42	- 5
PI-46000-PU 0050-5	25	- 15	- 5	PI-46000-PU 0110	55	- 45	- 7
PI-46000-PU 0050-6	25	- 17	- 5,5	PI-46000-PU 0110-1	55	- 45	- 10
PI-46000-PU 0052	26	- 18	- 7	PI-46000-PU 0110-2	55	- 45	- 7,5
PI-46000-PU 0052-2	26	- 18	- 5,5	PI-46000-PU 0112	56	- 46	- 7
PI-46000-PU 0056	28	- 16	- 9	PI-46000-PU 0120-1	60	- 44	- 12
PI-46000-PU 0060	30	- 22	- 6	PI-46000-PU 0120-2	60	- 50	- 10
PI-46000-PU 0060-1	30	- 20	- 7	PI-46000-PU 0120-3	60	- 50	- 7
PI-46000-PU 0060-2	30	- 15	- 10	PI-46000-PU 0120-4	60	- 50	- 7,3
PI-46000-PU 0064	32	- 24	- 5,5	PI-46000-PU 0124-1	62	- 52	- 7
PI-46000-PU 0064-1	32	- 22	- 7	PI-46000-PU 0126	63	- 53	- 6
PI-46000-PU 0064-2	32	- 22	- 5	PI-46000-PU 0126-1	63	- 53	- 4,3
PI-46000-PU 0070	35	- 25	- 6,5	PI-46000-PU 0126-3	63	- 53	- 7
PI-46000-PU 0070-1	35	- 25	- 7	PI-46000-PU 0126-4	63	- 50	- 9
PI-46000-PU 0070-2	35	- 27	- 10	PI-46000-PU 0126-8	63	- 48	- 12
PI-46000-PU 0070-3	35	- 25	- 8	PI-46000-PU 0130	65	- 55	- 7
PI-46000-PU 0070-4	35	- 20	- 10	PI-46000-PU 0140-1	70	- 50	- 14
PI-46000-PU 0072	36	- 28	- 7	PI-46000-PU 0140-2	70	- 60	- 10
PI-46000-PU 0072-2	36	- 24	- 6	PI-46000-PU 0140-4	70	- 62	- 8

**DTH-PI-46000-PU****Kolbendichtung / Piston Seal**

Nummer:	d	D	b	Nummer:	d	D	b
PI-46000-PU 0150	75	- 65	- 7,5	PI-46000-PU 0320-1	160	- 145	- 14
PI-46000-PU 0150-1	75	- 63	- 8,5	PI-46000-PU 0320-2	160	- 145	- 9
PI-46000-PU 0160-3	80	- 68	- 8,5	PI-46000-PU 0340	170	- 148	- 15
PI-46000-PU 0160-5	80	- 71	- 6,5	PI-46000-PU 0340-1	170	- 145	- 19
PI-46000-PU 0160-6	80	- 72	- 12	PI-46000-PU 0340-2	170	- 150	- 15
PI-46000-PU 0160-9	80	- 70	- 12	PI-46000-PU 0350	175	- 155	- 14
PI-46000-PU 0160-10	80	- 65	- 10	PI-46000-PU 0360	180	- 160	- 9
PI-46000-PU 0164	82	- 70	- 8	PI-46000-PU 0360-1	180	- 160	- 14
PI-46000-PU 0190-2	95	- 80	- 9	PI-46000-PU 0360-2	180	- 165	- 9
PI-46000-PU 0200	100	- 85	- 9	PI-46000-PU 0360-3	180	- 160	- 12
PI-46000-PU 0200-1	100	- 90	- 8,5	PI-46000-PU 0360-4	180	- 160	- 16
PI-46000-PU 0200-3	100	- 88	- 8,5	PI-46000-PU 0380-2	190	- 170	- 16
PI-46000-PU 0200-5	100	- 90	- 10,5	PI-46000-PU 0400	200	- 175	- 16
PI-46000-PU 0200-6	100	- 90	- 7,2	PI-46000-PU 0400-1	200	- 180	- 14
PI-46000-PU 0200-7	100	- 85	- 12	PI-46000-PU 0400-3	200	- 170	- 18
PI-46000-PU 0200-8	100	- 90	- 6,5	PI-46000-PU 0406	203	- 184	- 15
PI-46000-PU 0200-10	100	- 85	- 11,4	PI-46000-PU 0440	220	- 195	- 16
PI-46000-PU 0220	110	- 95	- 10	PI-46000-PU 0440-1	220	- 200	- 15
PI-46000-PU 0224	112	- 98	- 9	PI-46000-PU 0500	250	- 230	- 14
PI-46000-PU 0230	115	- 100	- 6	PI-46000-PU 0500-1	250	- 238	- 14
PI-46000-PU 0240-1	120	- 110	- 12	PI-46000-PU 0500-2	250	- 230	- 15
PI-46000-PU 0250	125	- 105	- 12	PI-46000-PU 0520	260	- 240	- 16
PI-46000-PU 0250-3	125	- 110	- 10	PI-46000-PU 0560	280	- 250	- 18
PI-46000-PU 0250-6	125	- 105	- 15	PI-46000-PU 0560-1	280	- 245	- 19
PI-46000-PU 0254	127	- 113	- 10	PI-46000-PU 0600	300	- 270	- 12
PI-46000-PU 0260	130	- 110	- 12	PI-46000-PU 0600-1	300	- 288	- 14
PI-46000-PU 0280	140	- 120	- 16	PI-46000-PU 0620	310	- 278	- 18
PI-46000-PU 0280-1	140	- 125	- 15	PI-46000-PU 0640	320	- 290	- 20
PI-46000-PU 0280-2	140	- 120	- 15	PI-46000-PU 0640-1	320	- 295	- 18
PI-46000-PU 0280-3	140	- 125	- 9	PI-46000-PU 0720	360	- 330	- 20
PI-46000-PU 0290	145	- 130	- 10	PI-46000-PU 0720-1	360	- 320	- 23
PI-46000-PU 0300	150	- 135	- 8	PI-46000-PU 0760	380	- 345	- 20
PI-46000-PU 0304	152	- 130	- 15	PI-46000-PU 0760-1	380	- 350	- 26
PI-46000-PU 0304-1	152	- 130	- 10	PI-46000-PU 0860	430	- 400	- 26
PI-46000-PU 0308	154	- 138	- 8	PI-46000-PU 0900	450	- 420	- 22
PI-46000-PU 0320	160	- 140	- 14				

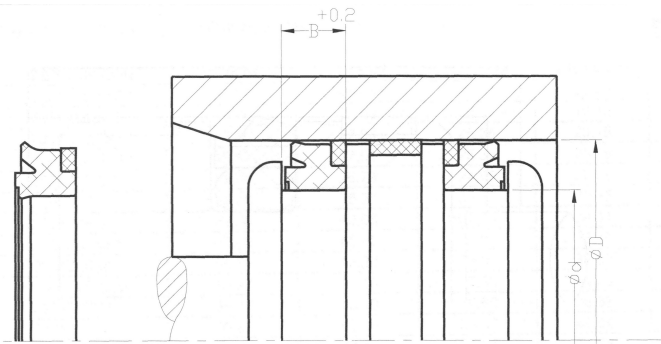

## DTH-PI-80000-PU

## Kolbendichtung / Piston Seal

Nummer:	d	D	b	Nummer:	d	D	b
PI-80000- 0028	14	- 8	- 6	PI-80000- 0140-2	70	- 55	- 10
PI-80000- 0072	36	- 27	- 6	PI-80000- 0140-3	70	- 50	- 16,5
PI-80000- 0080	40	- 25	- 11	PI-80000- 0150	75	- 55	- 13
PI-80000- 0090	45	- 30	- 11	PI-80000- 0160	80	- 60	- 13
PI-80000- 0090-1	45	- 30	- 9,5	PI-80000- 0160-1	80	- 60	- 12,5
PI-80000- 0100	50	- 35	- 11	PI-80000- 0180	90	- 70	- 13
PI-80000- 0100-1	50	- 35	- 9,5	PI-80000- 0200	100	- 80	- 13
PI-80000- 0110	55	- 40	- 11	PI-80000- 0200-1	100	- 88	- 8,5
PI-80000- 0110-1	55	- 40	- 9,5	PI-80000- 0220	110	- 90	- 13
PI-80000- 0120	60	- 45	- 11	PI-80000- 0250	125	- 100	- 16,2
PI-80000- 0120-1	60	- 45	- 9,5	PI-80000- 0280	140	- 115	- 15
PI-80000- 0126	63	- 48	- 10	PI-80000- 0300	150	- 120	- 19
PI-80000- 0126-1	63	- 50	- 10	PI-80000- 0340	170	- 150	- 12,5
PI-80000- 0130	65	- 50	- 11	PI-80000- 0360	180	- 150	- 19
PI-80000- 0140	70	- 50	- 13	PI-80000- 0440	220	- 190	- 17

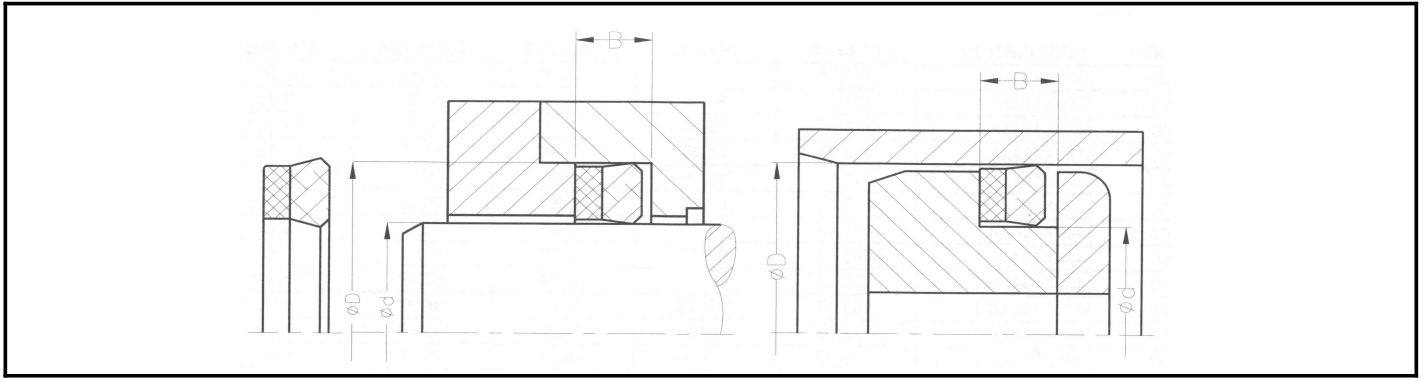

## DTH-PIRO-72000-NB-FA

## Stangen-Kolbendichtung / Piston Rod Seal

Nummer:	d	D	b	Nummer:	d	D	b
PIRO-72000- 0020	10	- 17	- 6,3	PIRO-72000- 0060-1	30	- 38	- 6
PIRO-72000- 0020-1	10	- 19	- 6,3	PIRO-72000- 0060-2	30	- 40	- 6,3
PIRO-72000- 0024	12	- 20	- 6,3	PIRO-72000- 0060-3	30	- 40	- 7,5
PIRO-72000- 0028	14	- 22	- 6,3	PIRO-72000- 0060-4	30	- 40	- 7
PIRO-72000- 0028-1	14	- 22	- 7	PIRO-72000- 0060-5	30	- 50	- 14,5
PIRO-72000- 0028-2	14	- 22	- 8,5	PIRO-72000- 0060-6	30	- 38	- 6,4
PIRO-72000- 0030	15	- 23	- 6,3	PIRO-72000- 0060-7	30	- 37,5	- 6,5
PIRO-72000- 0032	16	- 24	- 6,3	PIRO-72000- 0060-8	30	- 40	- 6
PIRO-72000- 0032-1	16	- 24	- 6,5	PIRO-72000- 0064	32	- 40	- 6,3
PIRO-72000- 0032-2	16	- 24	- 7	PIRO-72000- 0064-1	32	- 44	- 12,5
PIRO-72000- 0036	18	- 26	- 6,3	PIRO-72000- 0070	35	- 43	- 6,3
PIRO-72000- 0036-1	18	- 24	- 5,2	PIRO-72000- 0070-1	35	- 45	- 8
PIRO-72000- 0040	20	- 28	- 6,3	PIRO-72000- 0070-2	35	- 43	- 6
PIRO-72000- 0040-1	20	- 26	- 5,5	PIRO-72000- 0070-3	35	- 50	- 11,5
PIRO-72000- 0040-2	20	- 27	- 6,5	PIRO-72000- 0070-4	35	- 43	- 6,5
PIRO-72000- 0040-3	20	- 28	- 7	PIRO-72000- 0070-5	35	- 43	- 7,3
PIRO-72000- 0040-4	20	- 30	- 8,5	PIRO-72000- 0070-6	35	- 45	- 7,5
PIRO-72000- 0040-5	20	- 28	- 6	PIRO-72000- 0070-7	35	- 43	- 7
PIRO-72000- 0040-6	20	- 30	- 8	PIRO-72000- 0072	36	- 44	- 6,3
PIRO-72000- 0044	22	- 30	- 6,3	PIRO-72000- 0072-1	36	- 51	- 11
PIRO-72000- 0044-1	22	- 30	- 6,5	PIRO-72000- 0076	38	- 50	- 9,5
PIRO-72000- 0044-2	22	- 30	- 7	PIRO-72000- 0080	40	- 48	- 6,3
PIRO-72000- 0044-3	22	- 32	- 7,3	PIRO-72000- 0080-1	40	- 50	- 8
PIRO-72000- 0044-4	22	- 32	- 7	PIRO-72000- 0080-2	40	- 48	- 8
PIRO-72000- 0044-5	22	- 28	- 5,3	PIRO-72000- 0080-3	40	- 50	- 7
PIRO-72000- 0050	25	- 32	- 6,3	PIRO-72000- 0080-4	40	- 48	- 6,5
PIRO-72000- 0050-1	25	- 33	- 6,3	PIRO-72000- 0080-5	40	- 60	- 14,5
PIRO-72000- 0050-2	25	- 33	- 6	PIRO-72000- 0080-6	40	- 50	- 11
PIRO-72000- 0050-3	25	- 35	- 8,3	PIRO-72000- 0080-7	40	- 48	- 7,3
PIRO-72000- 0050-4	25	- 33	- 6,4	PIRO-72000- 0080-8	40	- 48	- 7
PIRO-72000- 0050-5	25	- 35	- 9	PIRO-72000- 0084	42	- 50	- 6,3
PIRO-72000- 0050-6	25	- 35	- 6	PIRO-72000- 0090	45	- 53	- 8,5
PIRO-72000- 0056	28	- 36	- 6,3	PIRO-72000- 0090-1	45	- 55	- 8
PIRO-72000- 0056-1	28	- 43	- 11	PIRO-72000- 0090-2	45	- 55	- 10,5
PIRO-72000- 0056-2	28	- 35	- 4,5	PIRO-72000- 0090-3	45	- 60	- 11
PIRO-72000- 0056-3	28	- 36	- 6,4	PIRO-72000- 0090-4	45	- 57	- 9,5
PIRO-72000- 0056-5	28	- 36	- 6	PIRO-72000- 0090-5	45	- 65	- 14,5
PIRO-72000- 0060	30	- 38	- 6,3	PIRO-72000- 0090-6	45	- 53	- 6,3

**DTH-PIRO-72000-NB-FA****Stangen-Kolbendichtung / Piston Rod Seal**

Nummer:	d	D	b	Nummer:	d	D	b
PIRO-72000- 0090-7	45	- 53	- 6	PIRO-72000- 0130-2	65	- 85	- 14,5
PIRO-72000- 0090-8	45	- 60	- 12	PIRO-72000- 0140	70	- 80	- 7,5
PIRO-72000- 0092	46	- 56	- 8	PIRO-72000- 0140-1	70	- 82	- 9,6
PIRO-72000- 0096	48	- 60	- 10	PIRO-72000- 0140-2	70	- 82	- 9
PIRO-72000- 0100	50	- 62	- 9,5	PIRO-72000- 0140-3	70	- 90	- 14
PIRO-72000- 0100-1	50	- 60	- 7,5	PIRO-72000- 0140-4	70	- 85	- 8
PIRO-72000- 0100-2	50	- 60	- 8	PIRO-72000- 0140-5	70	- 80	- 8
PIRO-72000- 0100-3	50	- 60	- 10	PIRO-72000- 0140-6	70	- 85	- 12
PIRO-72000- 0100-4	50	- 70	- 14,5	PIRO-72000- 0150	75	- 87	- 9,3
PIRO-72000- 0110	55	- 65	- 8	PIRO-72000- 0150-1	75	- 85	- 8
PIRO-72000- 0110-1	55	- 67	- 10,5	PIRO-72000- 0160	80	- 92	- 9,6
PIRO-72000- 0110-2	55	- 70	- 10,5	PIRO-72000- 0160-1	80	- 96	- 10
PIRO-72000- 0110-3	55	- 63	- 8,3	PIRO-72000- 0160-2	80	- 92	- 9
PIRO-72000- 0112	56	- 66	- 8	PIRO-72000- 0160-3	80	- 90	- 8
PIRO-72000- 0112-1	56	- 76	- 14	PIRO-72000- 0170	85	- 97	- 9,6
PIRO-72000- 0120	60	- 70	- 8	PIRO-72000- 0160-4	80	- 100	- 14
PIRO-72000- 0120-1	60	- 70	- 7,5	PIRO-72000- 0170-1	85	- 110	- 13,5
PIRO-72000- 0120-2	60	- 72	- 9,5	PIRO-72000- 0180	90	- 102	- 9,6
PIRO-72000- 0120-3	60	- 80	- 12,5	PIRO-72000- 0180-1	90	- 110	- 12,5
PIRO-72000- 0120-4	60	- 72	- 10	PIRO-72000- 0200	100	- 115	- 12
PIRO-72000- 0120-5	60	- 75	- 13	PIRO-72000- 0200-1	100	- 120	- 14
PIRO-72000- 0120-6	60	- 80	- 14,5	PIRO-72000- 0220	110	- 125	- 12
PIRO-72000- 0130	65	- 73	- 9,6	PIRO-72000- 0220-1	110	- 130	- 12
PIRO-72000- 0130-1	65	- 77	- 9,6	PIRO-72000- 0280	140	- 155	- 14

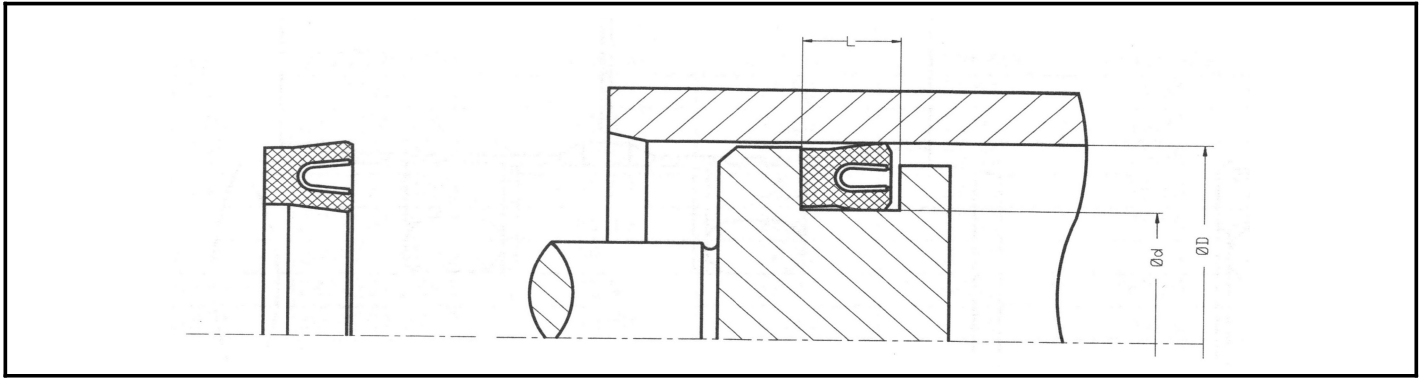

**DTH-PI-1502-PTFE-MET**

**Federvorgespannte Kolbendichtung / Spring Loaded Piston Seal**

Nummer:	d	D	b	Nummer:	d	D	b
PI-1502- 0012	6	- 3,1	- 2,4	PI-1502- 0180	90	- 80,6	- 7,1
PI-1502- 0020	10	- 7,1	- 2,4	PI-1502- 0200	100	- 90,6	- 7,1
PI-1502- 0040	20	- 15,5	- 3,6	PI-1502- 0220	110	- 100,6	- 7,1
PI-1502- 0050	25	- 18,8	- 4,8	PI-1502- 0230	115	- 124,4	- 7,1
PI-1502- 0060	30	- 23,8	- 4,8	PI-1502- 0240	120	- 110,6	- 7,1
PI-1502- 0080	40	- 33,8	- 4,8	PI-1502- 0250	125	- 112,8	- 9,5
PI-1502- 0100	50	- 40,6	- 7,1	PI-1502- 0260	130	- 117,8	- 9,5
PI-1502- 0120	60	- 50,6	- 7,1	PI-1502- 0280	140	- 127,8	- 9,5
PI-1502- 0126	63	- 53,6	- 7,1	PI-1502- 0300	150	- 137,8	- 9,5
PI-1502- 0140	70	- 60,6	- 7,1	PI-1502- 0320	160	- 147,8	- 9,5
PI-1502- 0150	75	- 65,6	- 7,1	PI-1502- 0340	170	- 157,8	- 9,5
PI-1502- 0160	80	- 70,6	- 7,1	PI-1502- 0400	200	- 187,8	- 9,5
PI-1502- 0170	85	- 75,6	- 7,1				

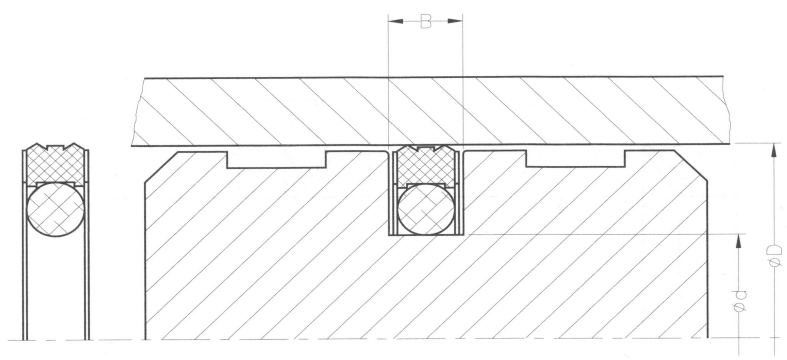

**DTH-PI-30000-NB-PU**

**Kolbendichtung / Piston Seal**

Nummer:	d	D	b	Nummer:	d	D	b
PI-30000- 0030	15	- 7,5	- 3,2	PI-30000- 0126-2	63	- 47,5	- 6,3
PI-30000- 0032	16	- 8,5	- 3,2	PI-30000- 0130-2	65	- 54	- 4,2
PI-30000- 0040	20	- 12,5	- 3,2	PI-30000- 0140-1	70	- 54,5	- 6,3
PI-30000- 0044	22	- 14,5	- 3,2	PI-30000- 0140-2	70	- 59	- 4,2
PI-30000- 0050-1	25	- 14	- 4,2	PI-30000- 0150-1	75	- 59,5	- 6,3
PI-30000- 0050-2	25	- 17,5	- 3,2	PI-30000- 0150-2	75	- 64	- 4,2
PI-30000- 0060	30	- 22,5	- 3,2	PI-30000- 0160-1	80	- 64,5	- 6,3
PI-30000- 0064-1	32	- 21	- 4,2	PI-30000- 0160-2	80	- 69	- 4,2
PI-30000- 0064-2	32	- 24,5	- 3,2	PI-30000- 0170	85	- 69,5	- 6,3
PI-30000- 0070	35	- 27,5	- 3,2	PI-30000- 180	90	- 74,5	- 6,3
PI-30000- 0076	38	- 30,5	- 3,2	PI-30000- 0190	95	- 79,5	- 6,3
PI-30000- 0080-1	40	- 24,5	- 6,3	PI-30000- 0200-1	100	- 84,5	- 6,3
PI-30000- 0080-2	40	- 29	- 4,2	PI-30000- 0200-2	100	- 89	- 4,2
PI-30000- 0080-3	40	- 32,5	- 3,2	PI-30000- 210	105	- 89,5	- 6,3
PI-30000- 0090-1	45	- 29,5	- 6,3	PI-30000- 220	110	- 94,5	- 6,3
PI-30000- 0090-2	45	- 34	- 4,2	PI-30000- 0230-1	115	- 94	- 8,1
PI-30000- 0096	48	- 37	- 4,2	PI-30000- 0230-2	115	- 99,5	- 6,3
PI-30000- 0098	49	- 38	- 4,2	PI-30000- 0240	120	- 104,5	- 6,3
PI-30000- 0100-1	50	- 34,5	- 6,3	PI-30000- 0250-1	125	- 104	- 8,1
PI-30000- 0100-2	50	- 39	- 4,2	PI-30000- 0250-2	125	- 109,5	- 6,3
PI-30000- 0104	52	- 36,5	- 6,3	PI-30000- 260	130	- 114,5	- 6,3
PI-30000- 0108	54	- 43	- 4,2	PI-30000- 0270	135	- 114	- 8,1
PI-30000- 0110-1	55	- 39,5	- 6,3	PI-30000- 0280	140	- 119	- 8,1
PI-30000- 0110-2	55	- 44	- 4,2	PI-30000- 0300	150	- 129	- 8,1
PI-30000- 0114	57,15	- 46,15	- 4,2	PI-30000- 0320	160	- 139	- 8,1
PI-30000- 0120-1	60	- 44,5	- 6,3	PI-30000- 340	170	- 149	- 8,1
PI-30000- 0120-2	60	- 49	- 4,2	PI-30000- 360	180	- 159	- 8,1
PI-30000- 0126-1	63	- 52	- 4,2	PI-30000- 0400	200	- 179	- 8,1
PI-30000- 0126,5	63,5	- 52,5	- 4,2	PI-30000- 0500	250	- 229	- 8,1
PI-30000- 0130-1	65	- 49,5	- 6,3				



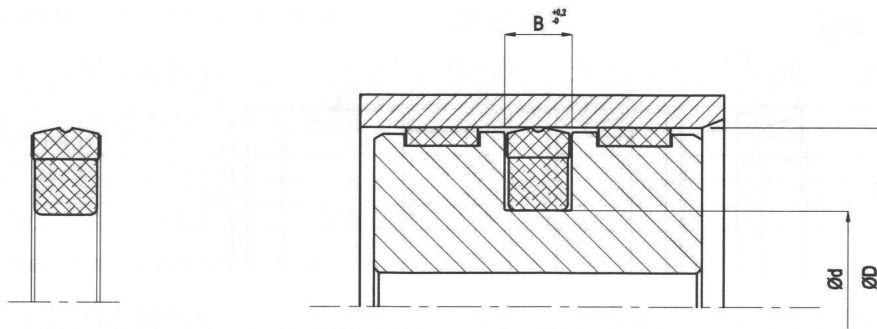

**DTH-PI-98000-PU-NB**

**Kolbendichtung / Piston Seal**

Nummer:	d	D	b	Nummer:	d	D	b
PI-98000- 0050	25	- 17,5	- 3,2	PI-98000- 0180	90	- 74,5	- 6,3
PI-98000- 0064	32	- 24,5	- 3,2	PI-98000- 0190	95	- 79,5	- 6,3
PI-98000- 0080	40	- 29	- 4,2	PI-98000- 0200	100	- 79	- 8,1
PI-98000- 0100	50	- 39	- 4,2	PI-98000- 0200-1	100	- 84,5	- 6,3
PI-98000- 0110	55	- 44	- 4,2	PI-98000- 0220	110	- 89	- 8,1
PI-98000- 0120	60	- 44,5	- 6,3	PI-98000- 0220-1	110	- 94,5	- 6,3
PI-98000- 0120-1	60	- 49	- 4,2	PI-98000- 0230	115	- 94	- 8,1
PI-98000- 0126	63	- 47,5	- 6,3	PI-98000- 0240	120	- 99	- 8,1
PI-98000- 0126-1	63	- 52	- 4,2	PI-98000- 0250	125	- 104	- 8,1
PI-98000- 0130	65	- 49,5	- 6,3	PI-98000- 0260	130	- 109	- 8,1
PI-98000- 0130-1	65	- 54	- 4,2	PI-98000- 0280	140	- 119	- 8,1
PI-98000- 0140	70	- 54,5	- 6,3	PI-98000- 0300	150	- 129	- 8,1
PI-98000- 0140-1	70	- 59	- 4,2	PI-98000- 0320	160	- 139	- 8,1
PI-98000- 0150	75	- 59,5	- 6,3	PI-98000- 0360	180	- 159	- 8,1
PI-98000- 0160	80	- 64,5	- 6,3	PI-98000- 0400	200	- 179	- 8,1
PI-98000- 0170	85	- 69,5	- 6,3				

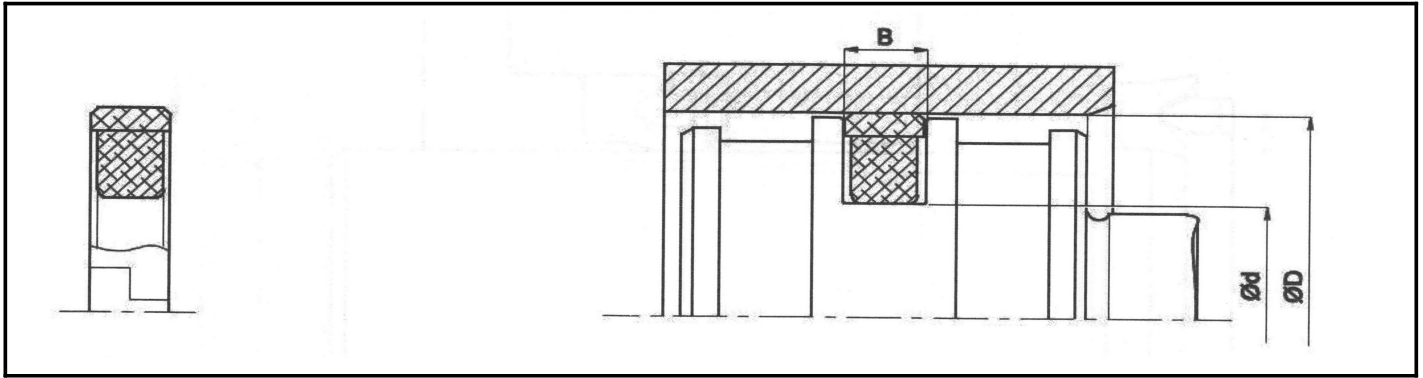

### DTH-PI-1002-PA-NB

### Kolbendichtung / Piston Seal

Nummer:	d	D	b	Nummer:	d	D	b
PI-1002- 0100	50	- 39	- 4,2	PI-1002- 0320	160	- 139	- 8,1
PI-1002- 0160	80	- 64,5	- 6,3	PI-1002- 0330	165	- 144	- 8,1
PI-1002- 0180	90	- 74,5	- 6,3	PI-1002- 0340	170	- 149	- 8,1
PI-1002- 0180-1	90	- 69	- 8,1	PI-1002- 0350	175	- 154	- 8,1
PI-1002- 0200	100	- 84,5	- 5,3	PI-1002- 0360	180	- 159	- 8,1
PI-1002- 0200-1	100	- 79	- 8,1	PI-1002- 0370	185	- 164	- 8,1
PI-1002- 0220	110	- 94,5	- 6,3	PI-1002- 0380	190	- 169	- 8,1
PI-1002- 0240	120	- 99	- 8,1	PI-1002- 0400	200	- 179	- 8,1
PI-1002- 0250	125	- 104	- 8,1	PI-1002- 0420	210	- 189	- 8,1
PI-1002- 0260	130	- 109	- 8,1	PI-1002- 0430	215	- 194	- 8,1
PI-1002- 0280	140	- 119	- 8,1	PI-1002- 0440	220	- 199	- 8,1
PI-1002- 0290	145	- 124	- 8,1	PI-1002- 0450	225	- 204	- 8,1
PI-1002- 0300	150	- 129	- 8,1	PI-1002- 0500	250	- 229	- 8,1

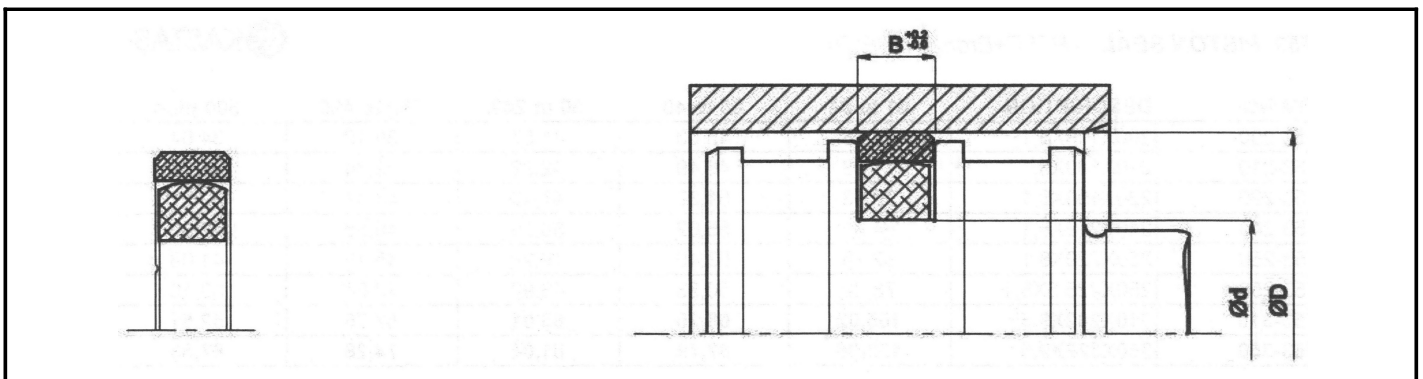

### DTH-PI-1510-PTFE-NBR

### Kolbendichtung / Piston Seal

Nummer:	d	D	b	Nummer:	d	D	b
PI-1510- 0440	220	- 195	- 12,5	PI-1510- 0720	360	- 330	- 15
PI-1510- 0450	225	- 200	- 12,5	PI-1510- 0860	430	- 400	- 15
PI-1510- 0520	260	- 230	- 15	PI-1510- 0980	490	- 460	- 15
PI-1510- 0640	320	- 290	- 15	PI-1510- 1180	590	- 555	- 17,5
PI-1510- 0680	340	- 310	- 15				

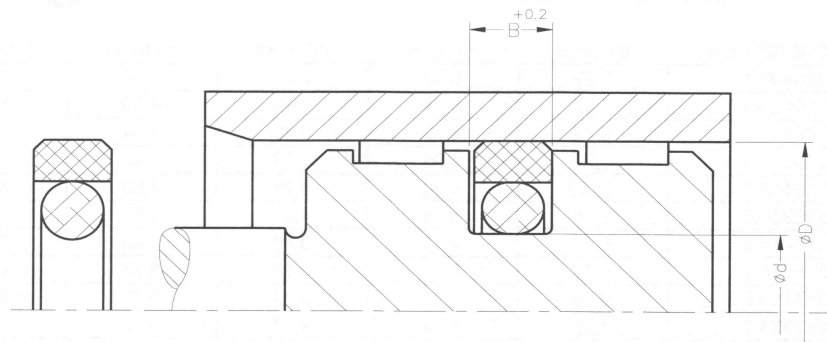

**DTH-PI-34000-PTFE-NB**

**Kolbendichtung / Piston Seal**

Nummer:	d	D	b	Nummer:	d	D	b
PI-34000- 0016	8	- 3,1	- 2,2	PI-34000- 0150-2	75	- 64	- 4,2
PI-34000- 0020	10	- 5,1	- 2,2	PI-34000- 0160-1	80	- 59	- 8,1
PI-34000- 0024	12	- 7,1	- 2,2	PI-34000- 0160-2	80	- 64,5	- 6,3
PI-34000- 0030	15	- 7,5	- 3,2	PI-34000- 0160-3	80	- 69	- 4,2
PI-34000- 0032	16	- 8,5	- 3,2	PI-34000- 0164	82,5	- 67	- 6,3
PI-34000- 0040	20	- 12,5	- 3,2	PI-34000- 0170-1	85	- 64	- 8,1
PI-34000- 0044-1	22	- 14,5	- 3,2	PI-34000- 0170-2	85	- 69,5	- 6,3
PI-34000- 0044-2	22,15	- 14,65	- 3,2	PI-34000- 0170-3	85	- 74	- 4,2
PI-34000- 0050-1	25	- 14	- 4,2	PI-34000- 0180-1	90	- 69	- 8,1
PI-34000- 0050-2	25	- 17,5	- 3,2	PI-34000- 0180-2	90	- 74,5	- 6,3
PI-34000- 0064-1	32	- 21	- 4,2	PI-34000- 0180-3	90	- 79	- 4,2
PI-34000- 0064-2	32	- 24,5	- 3,2	PI-34000- 0190-1	95	- 74	- 8,1
PI-34000- 0068	34	- 26,5	- 3,2	PI-34000- 0190-2	95	- 79,5	- 6,3
PI-34000- 0070-1	35	- 27,5	- 3,2	PI-34000- 0200-1	100	- 79	- 8,1
PI-34000- 0070-2	35	- 30,1	- 2,2	PI-34000- 0200-2	100	- 84,5	- 6,3
PI-34000- 0072	36	- 28,5	- 3,2	PI-34000- 0200-3	100	- 89	- 4,2
PI-34000- 0076	38	- 30,5	- 3,2	PI-34000- 0210	105	- 89,5	- 6,3
PI-34000- 0080-1	40	- 24,5	- 6,3	PI-34000- 0216	108	- 92,5	- 6,3
PI-34000- 0080-2	40	- 29	- 4,2	PI-34000- 0220-1	110	- 89	- 8,1
PI-34000- 0080-3	40	- 32,5	- 3,2	PI-34000- 0220-2	110	- 94,5	- 6,3
PI-34000- 0090	45	- 34	- 4,2	PI-34000- 0220-3	110	- 99	- 4,2
PI-34000- 0096	48	- 37	- 4,2	PI-34000- 0230-1	115	- 94	- 8,1
PI-34000- 0100-1	50	- 34,5	- 5,5	PI-34000- 0230-2	115	- 99,5	- 6,3
PI-34000- 0100-2	50	- 39	- 4,2	PI-34000- 0240-1	120	- 99	- 8,1
PI-34000- 0104	52	- 41	- 4,2	PI-34000- 0240-2	120	- 104,5	- 6,3
PI-34000- 0110	55	- 44	- 4,2	PI-34000- 0240-3	120	- 109	- 4,2
PI-34000- 0120-1	60	- 44,5	- 6,3	PI-34000- 0250-1	125	- 104	- 8,1
PI-34000- 0120-2	60	- 49	- 4,2	PI-34000- 0250-2	125	- 109,5	- 6,3
PI-34000- 0126-1	63	- 47,5	- 6,3	PI-34000- 0250-3	125	- 114	- 4,2
PI-34000- 0126-2	63	- 52	- 4,2	PI-34000- 0254	127	- 111,5	- 6,3
PI-34000- 0126-3	63	- 55,5	- 3,2	PI-34000- 0260-1	130	- 109	- 8,1
PI-34000- 0126-4	63,5	- 56	- 3,2	PI-34000- 0260-2	130	- 114,5	- 6,3
PI-34000- 0130-1	65	- 49,5	- 6,3	PI-34000- 0280-1	140	- 119	- 8,1
PI-34000- 0130-2	65	- 54	- 4,2	PI-34000- 0280-2	140	- 124,5	- 6,3
PI-34000- 0136	68	- 57	- 4,2	PI-34000- 0280-3	140	- 129	- 4,2
PI-34000- 0140-1	70	- 54,5	- 6,3	PI-34000- 0284	142	- 121	- 8,1
PI-34000- 0140-2	70	- 59	- 4,2	PI-34000- 0290	145	- 124	- 8,1
PI-34000- 0150-1	75	- 59,5	- 6,3	PI-34000- 0300-1	150	- 129	- 8,1

**DTH-PI-34000-PTFE-NB****Kolbendichtung / Piston Seal**

Nummer:	d	D	b	Nummer:	d	D	b
PI-34000- 0300-2	150	- 134,5	- 6,3	PI-34000- 0610	305	- 284	- 8,1
PI-34000- 0310	155	- 134	- 8,1	PI-34000- 0620	310	- 289	- 8,1
PI-34000- 0320	160	- 139	- 8,1	PI-34000- 0630	315	- 294	- 8,1
PI-34000- 0330	165	- 144	- 8,1	PI-34000- 0640-1	320	- 295,5	- 8,1
PI-34000- 0340	170	- 149	- 8,1	PI-34000- 0640-2	320	- 299	- 8,1
PI-34000- 0350	175	- 154	- 8,1	PI-34000- 0650-1	325	- 300,5	- 8,1
PI-34000- 0360	180	- 159	- 8,1	PI-34000- 0650-2	325	- 304	- 8,1
PI-34000- 0370-1	185	- 164	- 8,1	PI-34000- 0660	330	- 305,5	- 8,1
PI-34000- 0370-2	185	- 169,5	- 6,3	PI-34000- 0680	340	- 315,5	- 8,1
PI-34000- 0380	190	- 169	- 8,1	PI-34000- 0700	350	- 325,5	- 8,1
PI-34000- 0390	195	- 174	- 8,1	PI-34000- 0720	360	- 335,5	- 8,1
PI-34000- 0400-1	200	- 179	- 8,1	PI-34000- 0740	370	- 345,5	- 8,1
PI-34000- 0400-2	200	- 184,5	- 6,3	PI-34000- 0760	380	- 355,5	- 8,1
PI-34000- 0410	205	- 184	- 8,1	PI-34000- 0780	390	- 365,5	- 8,1
PI-34000- 0420	210	- 189	- 8,1	PI-34000- 0800	400	- 375,5	- 8,1
PI-34000- 0430	215	- 194	- 8,1	PI-34000- 0840	420	- 395,5	- 8,1
PI-34000- 0440	220	- 199	- 8,1	PI-34000- 0860	430	- 405,5	- 8,1
PI-34000- 0450	225	- 204	- 8,1	PI-34000- 0880	440	- 415,5	- 8,1
PI-34000- 0460	230	- 209	- 8,1	PI-34000- 0900	450	- 425,5	- 8,1
PI-34000- 0480	240	- 219	- 8,1	PI-34000- 0920	460	- 435,5	- 8,1
PI-34000- 0490	245	- 224	- 8,1	PI-34000- 0940	470	- 445,5	- 8,1
PI-34000- 0500	250	- 229	- 8,1	PI-34000- 0960	480	- 455,5	- 8,1
PI-34000- 0508	254	- 233	- 8,1	PI-34000- 1000	500	- 475,5	- 8,1
PI-34000- 0510	255	- 234	- 8,1	PI-34000- 1040	520	- 495,5	- 8,1
PI-34000- 0520	260	- 239	- 8,1	PI-34000- 1060	530	- 505,5	- 8,1
PI-34000- 0530	265	- 244	- 8,1	PI-34000- 1080	540	- 515,5	- 8,1
PI-34000- 0540	270	- 249	- 8,1	PI-34000- 1100	550	- 525,5	- 8,1
PI-34000- 0550	275	- 254	- 8,1	PI-34000- 1120	560	- 535,5	- 8,1
PI-34000- 0560	280	- 259	- 8,1	PI-34000- 1130	565	- 540,5	- 8,1
PI-34000- 0580	290	- 269	- 8,1	PI-34000- 1160	580	- 555,5	- 8,1
PI-34000- 0600-1	300	- 275,5	- 8,1	PI-34000- 1200	600	- 575,5	- 8,1
PI-34000- 0600-2	300	- 279	- 8,1	PI-34000- 1220	610	- 585,5	- 8,1

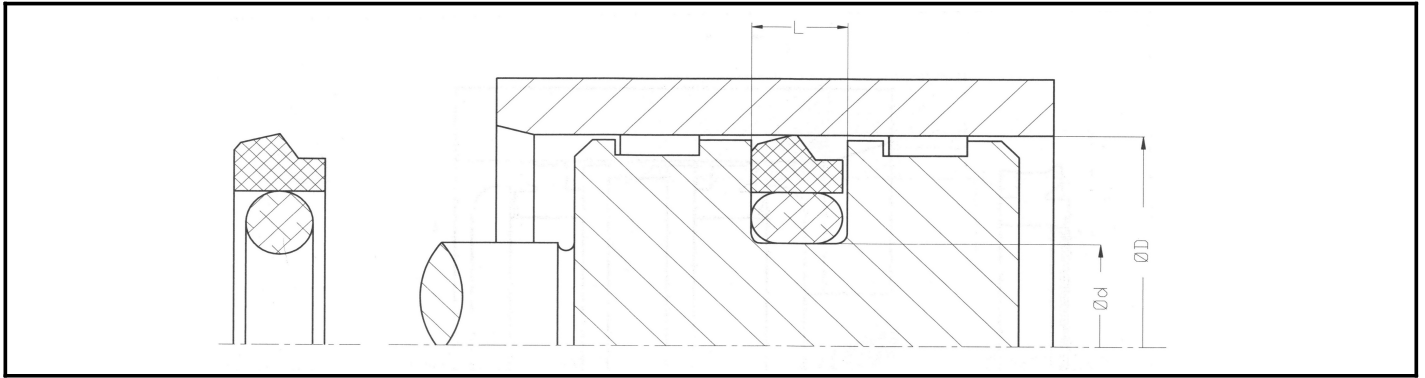

**DTH-PI-82000-PTFE-NB**

**Kolbendichtung / Piston Seal**

Nummer:	d	D	b	Nummer:	d	D	b
PI-82000- 0036	18	- 10,7	- 3,2	PI-82000- 0300	150	- 134,9	- 6,3
PI-82000- 0050	25	- 17,7	- 3,2	PI-82000- 0320	160	- 144,9	- 6,3
PI-82000- 0060	30	- 19,3	- 4,2	PI-82000- 0320-1	160	- 139,5	- 8,1
PI-82000- 0060-1	30	- 22,7	- 3,2	PI-82000- 0340	170	- 154,9	- 6,3
PI-82000- 0064	32	- 21,3	- 4,2	PI-82000- 0360	180	- 164,9	- 6,3
PI-82000- 0080	40	- 29,3	- 4,2	PI-82000- 0360-1	180	- 159,5	- 8,1
PI-82000- 0090	45	- 34,3	- 4,2	PI-82000- 0380	190	- 174,9	- 6,3
PI-82000- 0100	50	- 39,3	- 4,2	PI-82000- 0400	200	- 179,5	- 8,1
PI-82000- 0110	55	- 44,3	- 4,2	PI-82000- 0420	210	- 189,5	- 8,1
PI-82000- 0120	60	- 44,9	- 6,3	PI-82000- 0430	215	- 194,5	- 8,1
PI-82000- 0120-1	60	- 49,3	- 4,2	PI-82000- 0440	220	- 199,5	- 8,1
PI-82000- 0126	63	- 47,9	- 6,3	PI-82000- 0450	225	- 204,5	- 8,1
PI-82000- 0130	49,9	- 65	- 6,3	PI-82000- 0460	230	- 209,5	- 8,1
PI-82000- 0140	70	- 59,3	- 4,2	PI-82000- 0480	240	- 219,5	- 8,1
PI-82000- 0140-1	70	- 54,9	- 6,3	PI-82000- 0500	250	- 229,5	- 8,1
PI-82000- 0150	75	- 59,9	- 6,3	PI-82000- 0520	260	- 236	- 8,1
PI-82000- 0160	80	- 64,9	- 6,3	PI-82000- 0540	270	- 246	- 8,1
PI-82000- 0170	85	- 69,9	- 6,3	PI-82000- 0560	280	- 256	- 8,1
PI-82000- 0180	90	- 74,9	- 6,3	PI-82000- 0580	290	- 266	- 8,1
PI-82000- 0190	95	- 79,9	- 6,3	PI-82000- 0600	300	- 276	- 8,1
PI-82000- 0200	100	- 84,9	- 6,3	PI-82000- 0640	320	- 296	- 8,1
PI-82000- 0220	110	- 94,9	- 6,3	PI-82000- 0680	340	- 316	- 8,1
PI-82000- 0230	115	- 99,9	- 6,3	PI-82000- 0800	400	- 376	- 8,1
PI-82000- 0240	120	- 104,9	- 6,3	PI-82000- 0900	450	- 426	- 8,1
PI-82000- 0250	125	- 109,9	- 6,3	PI-82000- 0920	460	- 436	- 8,1
PI-82000- 0260	130	- 109,5	- 8,1	PI-82000- 0960	480	- 456	- 8,1
PI-82000- 0260-1	130	- 114,9	- 6,3	PI-82000- 1000	500	- 476	- 8,1
PI-82000- 0280	140	- 124,9	- 6,3				

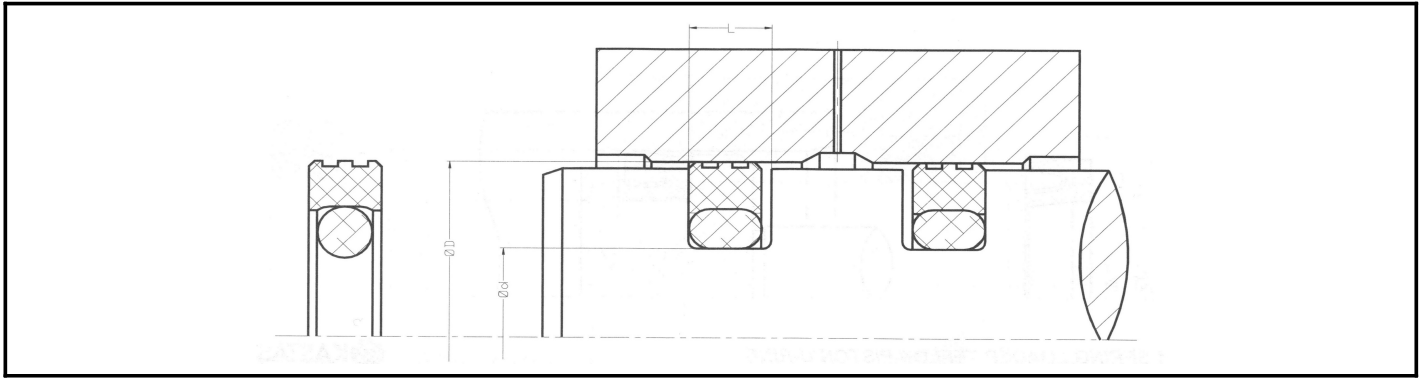

**DTH-PI-1504-PTFE-NB**

**Rotations Kolbendichtung / Piston Seal for Rotating Application**

Nummer:	d	D	b	Nummer:	d	D	b
PI-1504- 0030	15	- 10,1	- 2,2	PI-1504- 0220	110	- 99	- 4,2
PI-1504- 0040	20	- 15,1	- 2,2	PI-1504- 0230	115	- 104	- 4,2
PI-1504- 0050	25	- 20,1	- 2,2	PI-1504- 0240	120	- 109	- 4,2
PI-1504- 0060	30	- 25,1	- 2,2	PI-1504- 0250	125	- 114	- 4,2
PI-1504- 0064	32	- 27,1	- 2,2	PI-1504- 0260	130	- 119	- 4,2
PI-1504- 0070	35	- 30,1	- 2,2	PI-1504- 0270	135	- 119,5	- 6,3
PI-1504- 0080	40	- 32,5	- 3,2	PI-1504- 0270-1	135	- 124	- 4,2
PI-1504- 0080-1	40	- 29	- 4,2	PI-1504- 0280	140	- 124,5	- 6,3
PI-1504- 0090	45	- 37,5	- 3,2	PI-1504- 0290	145	- 134	- 4,2
PI-1504- 0100	50	- 42,5	- 3,2	PI-1504- 0300	150	- 134,5	- 6,3
PI-1504- 0104	52	- 44,5	- 3,2	PI-1504- 0320	160	- 144,5	- 6,3
PI-1504- 0110	55	- 47,5	- 3,2	PI-1504- 0340	170	- 154,5	- 6,3
PI-1504- 0120	60	- 52,5	- 3,2	PI-1504- 0360	180	- 164,5	- 6,3
PI-1504- 0126	63	- 55,5	- 3,2	PI-1504- 0380	190	- 174,5	- 6,3
PI-1504- 0130	65	- 57,5	- 3,2	PI-1504- 0400	200	- 184,5	- 6,3
PI-1504- 0140	70	- 62,5	- 3,2	PI-1504- 0420	210	- 194,5	- 6,3
PI-1504- 0150	75	- 67,5	- 3,2	PI-1504- 0440	220	- 204,5	- 6,3
PI-1504- 0160	80	- 69	- 4,2	PI-1504- 0460	230	- 214,5	- 6,3
PI-1504- 0160-1	80	- 64,5	- 6,3	PI-1504- 0480	240	- 224,5	- 6,3
PI-1504- 0170	85	- 74	- 4,2	PI-1504- 0500	250	- 234,5	- 6,3
PI-1504- 0180	90	- 79	- 4,2	PI-1504- 0520	260	- 244,5	- 6,3
PI-1504- 0190	95	- 84	- 4,2	PI-1504- 0560	280	- 264,5	- 6,3
PI-1504- 0200	100	- 89	- 4,2	PI-1504- 0600	300	- 284,5	- 6,3
PI-1504- 0210	105	- 94	- 4,2				

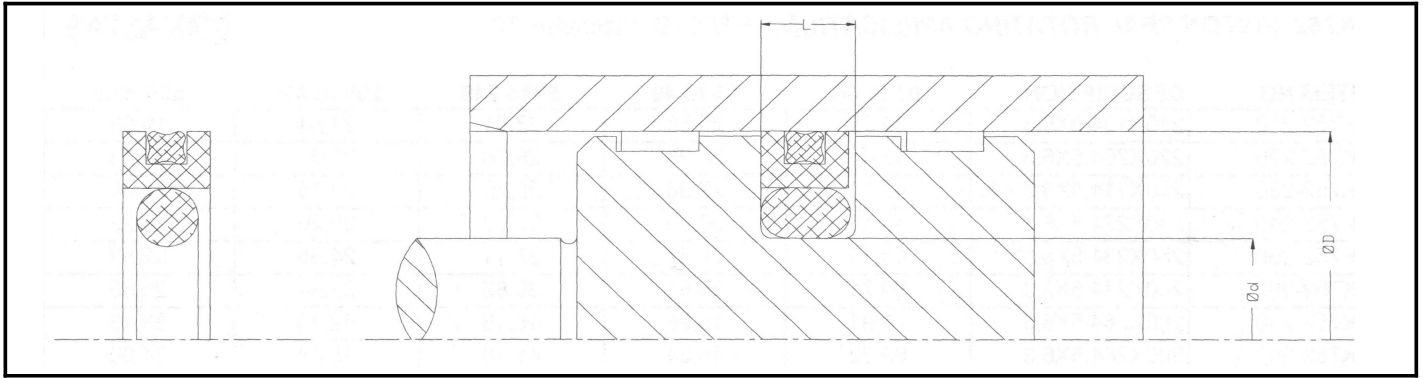

**DTH-PI-1506-PTFE-NBR**

**Kolbendichtung / Piston Seal**

Nummer:	d	D	b	Nummer:	d	D	b
PI-1506- 0032	16	- 5	- 4,2	PI-1506- 0190	95	- 79,5	- 6,3
PI-1506- 0044	22	- 11	- 4,2	PI-1506- 0200	100	- 84,5	- 6,3
PI-1506- 0050	25	- 14	- 4,2	PI-1506- 0200-1	100	- 79	- 8,1
PI-1506- 0056	28	- 17	- 4,2	PI-1506- 0210	105	- 89,5	- 6,3
PI-1506- 0060	30	- 19	- 4,2	PI-1506- 0220	110	- 94,5	- 6,3
PI-1506- 0064	32	- 21	- 4,2	PI-1506- 0230	115	- 99,5	- 6,3
PI-1506- 0070	35	- 24	- 4,2	PI-1506- 0240	120	- 104,5	- 6,3
PI-1506- 0080	40	- 29	- 4,2	PI-1506- 0250	125	- 109,5	- 6,3
PI-1506- 0084	42	- 31	- 4,2	PI-1506- 0260	130	- 114,5	- 6,3
PI-1506- 0090	45	- 34	- 4,2	PI-1506- 0270	135	- 114	- 8,1
PI-1506- 0100	50	- 39	- 4,2	PI-1506- 0280	140	- 119	- 8,1
PI-1506- 0100-1	50	- 34,5	- 6,3	PI-1506- 0300	150	- 129	- 8,1
PI-1506- 0104	52	- 41	- 4,2	PI-1506- 0320	160	- 139	- 8,1
PI-1506- 0110	55	- 44	- 4,2	PI-1506- 0340	170	- 149	- 8,1
PI-1506- 0120	60	- 49	- 4,2	PI-1506- 0360	180	- 159	- 8,1
PI-1506- 0126	63	- 52	- 4,2	PI-1506- 0380	190	- 169	- 8,1
PI-1506- 0126-1	63	- 47,5	- 6,3	PI-1506- 0400	200	- 179	- 8,1
PI-1506- 0130	65	- 54	- 4,2	PI-1506- 0420	210	- 189	- 8,1
PI-1506- 0140	70	- 59	- 4,2	PI-1506- 0440	220	- 199	- 8,1
PI-1506- 0140-1	70	- 54,5	- 6,3	PI-1506- 0480	240	- 219	- 8,1
PI-1506- 0150	75	- 64	- 4,2	PI-1506- 0500	250	- 229	- 8,1
PI-1506- 0160	80	- 64,5	- 6,3	PI-1506- 0500-1	250	- 225,5	- 8,1
PI-1506- 0160-1	80	- 59	- 8,1	PI-1506- 0620	310	- 282	- 9,5
PI-1506- 0170	85	- 69,5	- 6,3	PI-1506- 0700	350	- 322	- 9,5
PI-1506- 0180	90	- 74,5	- 6,3				

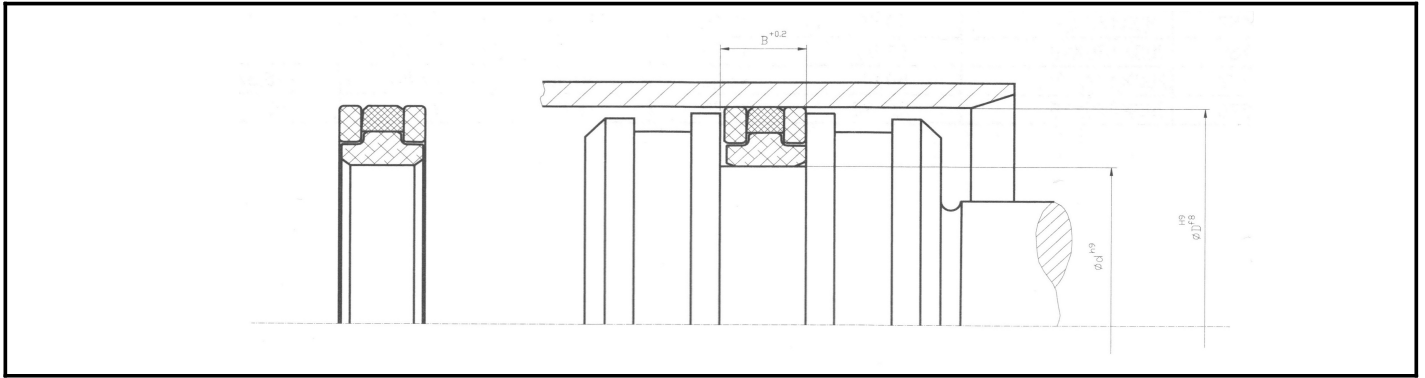

**DTH-PI-38000-PTFE-NB-POM**

**Schwerhydraulik Kolbendichtung / Heavy Duty Piston Seal**

Nummer:	d	D	b	Nummer:	d	D	b
PI-38000- 0100	50	- 36	- 9	PI-38000- 0240	120	- 105	- 12,5
PI-38000- 0110	55	- 41	- 9	PI-38000- 0250	125	- 102	- 16
PI-38000- 0120	60	- 46	- 9	PI-38000- 0260	130	- 107	- 16
PI-38000- 0120-1	60	- 50	- 8	PI-38000- 0270	135	- 112	- 16
PI-38000- 0126	63	- 48	- 11	PI-38000- 0280	140	- 117	- 16
PI-38000- 0130	65	- 50	- 11	PI-38000- 0290	1450	- 122	- 16
PI-38000- 0140	70	- 55	- 11	PI-38000- 0300	150	- 127	- 16
PI-38000- 0150	75	- 60	- 11	PI-38000- 0300-1	150	- 130	- 18
PI-38000- 0160	80	- 65	- 11	PI-38000- 0300-2	150	- 135	- 12,5
PI-38000- 0170	85	- 70	- 11	PI-38000- 0320	160	- 137	- 16
PI-38000- 0180	90	- 75	- 11	PI-38000- 0320-1	160	- 145	- 12,5
PI-38000- 0190	95	- 80	- 11	PI-38000- 0330	165	- 142	- 15,5
PI-38000- 0200	100	- 85	- 12,5	PI-38000- 0330-1	165	- 145	- 17
PI-38000- 0210	105	- 88	- 14	PI-38000- 0340	170	- 147	- 16
PI-38000- 0210-1	105	- 90	- 12,5	PI-38000- 0340-1	170	- 155	- 16
PI-38000- 0210-2	105	- 90	- 13,5	PI-38000- 0360	180	- 157	- 16
PI-38000- 0210-3	105	- 90	- 14	PI-38000- 0360-1	180	- 160	- 18
PI-38000- 0220	110	- 95	- 12,5	PI-38000- 0400	200	- 177	- 16
PI-38000- 0230	115	- 100	- 12,5	PI-38000- 0580	290	- 270	- 16



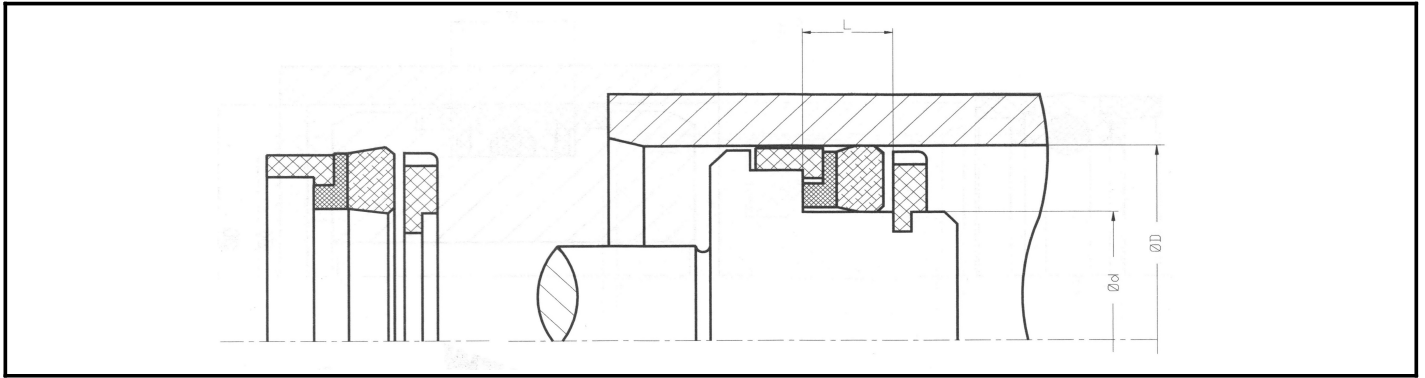

**DTH-PI-86000-NB-FA-POM**

**Kolbendichtung / Piston Seal**

Nummer:	d	D	b	Nummer:	d	D	b
PI-86000- 0064	32	- 20	- 10	PI-86000- 0160	80	- 60	- 14,5
PI-86000- 0070	35	- 22	- 10	PI-86000- 0170	85	- 70	- 12
PI-86000- 0076	38	- 25	- 10	PI-86000- 0180	90	- 70	- 14,5
PI-86000- 0080	40	- 26	- 9,4	PI-86000- 0190	95	- 75	- 14,5
PI-86000- 0090	45	- 30	- 9,5	PI-86000- 0200	100	- 80	- 14,5
PI-86000- 0090-1	45	- 35	- 8,5	PI-86000- 0208	104,5	- 85	- 13
PI-86000- 0100	50	- 30	- 14,5	PI-86000- 0210	105	- 85	- 14
PI-86000- 0110	55	- 40	- 11	PI-86000- 0220	110	- 90	- 13
PI-86000- 0120	60	- 40	- 14,5	PI-86000- 0230	115	- 95	- 14,5
PI-86000- 0126	63	- 45	- 11	PI-86000- 0240	120	- 100	- 12,5
PI-86000- 0126-1	63,5	- 47,62	- 9,52	PI-86000- 0250	125	- 105	- 12,5
PI-86000- 0130	65	- 45	- 14	PI-86000- 0260	130	- 110	- 12
PI-86000- 0130-1	65	- 50	- 10,5	PI-86000- 0300	150	- 125	- 14
PI-86000- 0140	70	- 50	- 14,5	PI-86000- 0320	160	- 140	- 14
PI-86000- 0150	75	- 55	- 14,5	PI-86000- 0400	200	- 180	- 14

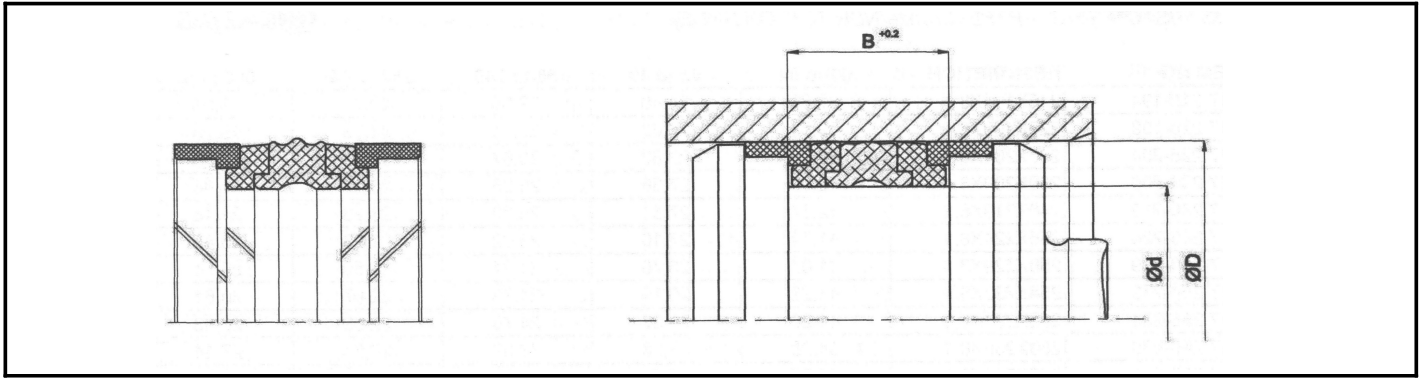

### DTH-PI-36000-NB-TPE-POM

### Kompaktkolbendichtung / Compact Piston Seal

Nummer:	d	D	b	Nummer:	d	D	b
PI-36000- 0040	20	- 11	- 13,5	PI-36000- 0110-2	55	- 39	- 18,4
PI-36000- 0044	22	- 13	- 13,5	PI-36000- 0110-3	55	- 45	- 12,5
PI-36000- 0050-1	25	- 15	- 16,4	PI-36000- 0112	56	- 40	- 20,5
PI-36000- 0050-2	25	- 15	- 12	PI-36000- 0120-1	60	- 44	- 20,5
PI-36000- 0050-3	25	- 15	- 12,5	PI-36000- 0120-2	60	- 44	- 18,4
PI-36000- 0050-4	25	- 16	- 13,5	PI-36000- 0120-3	60	- 48	- 20,5
PI-36000- 0050-5	25	- 17	- 13,5	PI-36000- 0126-1	63	- 47	- 20,5
PI-36000- 0050-6	25	- 17	- 10	PI-36000- 0126-2	63	- 47	- 18,4
PI-36000- 0056	28	- 19	- 13,5	PI-36000- 0126-3	63	- 47	- 19,4
PI-36000- 0060-1	30	- 17	- 15,4	PI-36000- 0126-4	63	- 48	- 20
PI-36000- 0060-2	30	- 21	- 13,5	PI-36000- 0126-5	63	- 51	- 20,5
PI-36000- 0060-3	30	- 22	- 13,5	PI-36000- 0126-6	63	- 53	- 12,5
PI-36000- 0064-1	32	- 19	- 15	PI-36000- 0130-1	65	- 49	- 20,5
PI-36000- 0064-2	32	- 22	- 16,4	PI-36000- 0130-2	65	- 50	- 18,4
PI-36000- 0064-3	32	- 22	- 15,5	PI-36000- 0134	67	- 51	- 18,4
PI-36000- 0064-4	32	- 22	- 12,5	PI-36000- 0140-1	70	- 50	- 22,4
PI-36000- 0064-5	32	- 24	- 15,5	PI-36000- 0140-2	70	- 54	- 20,5
PI-36000- 0064-6	32	- 24	- 10	PI-36000- 0140-3	70	- 58	- 20,5
PI-36000- 0070-1	35	- 25	- 16,4	PI-36000- 0140-4	70	- 55	- 20
PI-36000- 0070-2	35	- 27	- 15,5	PI-36000- 0150-1	75	- 55	- 22,4
PI-36000- 0080-1	40	- 24	- 18,4	PI-36000- 0150-2	75	- 59	- 20,5
PI-36000- 0080-2	40	- 26	- 15,5	PI-36000- 0160-1	80	- 60	- 22,4
PI-36000- 0080-3	40	- 30	- 16,4	PI-36000- 0160-2	80	- 60	- 35/9,5
PI-36000- 0080-4	40	- 30	- 12,5	PI-36000- 0160-3	80	- 60	- 25
PI-36000- 0080-5	40	- 30	- 12,4	PI-36000- 0160-4	80	- 62	- 22,5
PI-36000- 0080-6	40	- 32	- 15,5	PI-36000- 0160-5	80	- 65	- 20
PI-36000- 0080-7	40	- 32	- 10	PI-36000- 0160-6	80	- 66	- 22,4
PI-36000- 0084	42	- 28	- 15,5	PI-36000- 0170-1	85	- 65	- 22,4
PI-36000- 0090-1	45	- 29	- 18,4	PI-36000- 0170-2	85	- 65	- 21,4
PI-36000- 0090-2	45	- 31	- 15,5	PI-36000- 0170-3	85	- 75	- 20
PI-36000- 0090-3	45	- 35	- 16,4	PI-36000- 0180-1	90	- 70	- 22,4
PI-36000- 0090-4	45	- 37	- 15,5	PI-36000- 0180-2	90	- 72	- 22,5
PI-36000- 0100-1	50	- 34	- 20,5	PI-36000- 0180-3	90	- 72	- 22,5/3,6
PI-36000- 0100-2	50	- 34	- 18,4	PI-36000- 0180-4	90	- 75	- 20
PI-36000- 0100-3	50	- 35	- 20	PI-36000- 0180-5	90	- 76	- 22,4
PI-36000- 0100-4	50	- 38	- 20,5	PI-36000- 0190-1	95	- 75	- 22,4
PI-36000- 0100-5	50	- 40	- 12,5	PI-36000- 0190-2	95	- 81	- 22,4
PI-36000- 0110-1	55	- 39	- 20,5	PI-36000- 0200-1	100	- 75	- 22,4

**DTH-PI-36000-NB-TPE-POM**

**Kompaktkolbendichtung / Compact Piston Seal**

Nummer:	d	D	b	Nummer:	d	D	b
PI-36000- 0200-2	100	- 80	- 25,4	PI-36000- 0300-5	150	- 133	- 26,5
PI-36000- 0200-3	100	- 80	- 35	PI-36000- 0310-1	155	- 130	- 25,4/6,35
PI-36000- 0200-4	100	- 80	- 25	PI-36000- 0310-2	155	- 130	- 25,4/9,52
PI-36000- 0200-5	100	- 82	- 22,5	PI-36000- 0320-1	160	- 130	- 25,4/6,35
PI-36000- 0200-6	100	- 85	- 20	PI-36000- 0320-2	160	- 130	- 25,4/9,52
PI-36000- 0200-7	100	- 86	- 22,4	PI-36000- 0320-3	160	- 130	- 25,4/9,52
PI-36000- 0210-1	105	- 80	- 22,4	PI-36000- 0320-4	160	- 135	- 25,4
PI-36000- 0210-2	105	- 80	- 22,4/6,35	PI-36000- 0320-5	160	- 135	- 45
PI-36000- 0220-1	110	- 85	- 22,4	PI-36000- 0320-6	160	- 135	- 32
PI-36000- 0220-2	110	- 85	- 25,4	PI-36000- 0320-7	160	- 138	- 26,5/5,10
PI-36000- 0220-3	110	- 90	- 35	PI-36000- 0320-8	160	- 140	- 25
PI-36000- 0220-4	110	- 90	- 25,3	PI-36000- 0320-9	160	- 143	- 26,5
PI-36000- 0220-5	110	- 92	- 22,5	PI-36000- 0330-1	165	- 140	- 25,4
PI-36000- 0220-6	110	- 95	- 20	PI-36000- 0330-2	165	- 143	- 26,5
PI-36000- 0220-7	110	- 96	- 22,4	PI-36000- 0340-1	170	- 140	- 25,4
PI-36000- 0230-1	115	- 90	- 22,4	PI-36000- 0340-2	170	- 145	- 25,4
PI-36000- 0230-2	115	- 97	- 22,4	PI-36000- 0340-3	170	- 148	- 26,5
PI-36000- 0230-3	115	- 97	- 22,4/3,6	PI-36000- 0360-1	180	- 150	- 35,4
PI-36000- 0230-4	115	- 101	- 22,4	PI-36000- 0360-2	180	- 150	- 36
PI-36000- 0240-1	120	- 95	- 22,4	PI-36000- 0360-3	180	- 155	- 25,4
PI-36000- 0240-2	120	- 100	- 35/9,5	PI-36000- 0360-4	180	- 158	- 26,5
PI-36000- 0240-3	120	- 106	- 22,4	PI-36000- 0360-5	180	- 163	- 26,5
PI-36000- 0250-1	125	- 100	- 25,4	PI-36000- 0370	185	- 160	- 25,4
PI-36000- 0250-2	125	- 100	- 45	PI-36000- 0380	190	- 165	- 25,4
PI-36000- 0250-3	125	- 100	- 32	PI-36000- 0390	195	- 170	- 25,4
PI-36000- 0250-4	125	- 103	- 26,5	PI-36000- 0400-1	200	- 170	- 35,4
PI-36000- 0250-5	125	- 105	- 25,4	PI-36000- 0400-2	200	- 170	- 36
PI-36000- 0250-6	125	- 105	- 25	PI-36000- 0400-3	200	- 175	- 31,5
PI-36000- 0250-7	125	- 108	- 26,5	PI-36000- 0400-4	200	- 175	- 25,4
PI-36000- 0260-1	130	- 105	- 25,4/6,35	PI-36000- 0400-5	200	- 180	- 31,5
PI-36000- 0260-2	130	- 105	- 25,4/9,52	PI-36000- 0420	210	- 185	- 25,4
PI-36000- 0260-3	130	- 105	- 25,4/9,52	PI-36000- 0440-1	220	- 190	- 35,4
PI-36000- 0270-1	135	- 110	- 25,4/9,52	PI-36000- 0440-2	220	- 190	- 35,4
PI-36000- 0270-2	135	- 110	- 25,4/6,35	PI-36000- 0440-3	220	- 195	- 25,4
PI-36000- 0280-1	140	- 115	- 25,4/6,35	PI-36000- 0440-4	220	- 200	- 31,5
PI-36000- 0280-2	140	- 115	- 25,4/9,52	PI-36000- 0450-1	225	- 195	- 35,5
PI-36000- 0280-3	140	- 115	- 25,4/6,35	PI-36000- 0450-2	225	- 200	- 31,5
PI-36000- 0280-4	140	- 115	- 45	PI-36000- 0460	230	- 205	- 25,4
PI-36000- 0280-5	140	- 118	- 26,5	PI-36000- 0480	240	- 215	- 25,4
PI-36000- 0280-6	140	- 120	- 25	PI-36000- 0500-1	250	- 220	- 35,4
PI-36000- 0280-7	140	- 123	- 26,5	PI-36000- 0500-2	250	- 225	- 25,4
PI-36000- 0290	145	- 120	- 25,4	PI-36000- 0500-3	250	- 230	- 31,5
PI-36000- 0300-1	150	- 125	- 25,4	PI-36000- 0520	260	- 235	- 35,4
PI-36000- 0300-2	150	- 125	- 25,4/6,35	PI-36000- 0560-1	280	- 250	- 36,4
PI-36000- 0300-3	150	- 128	- 26,5	PI-36000- 0560-2	280	- 250	- 35,4
PI-36000- 0300-4	150	- 130	- 25,4				

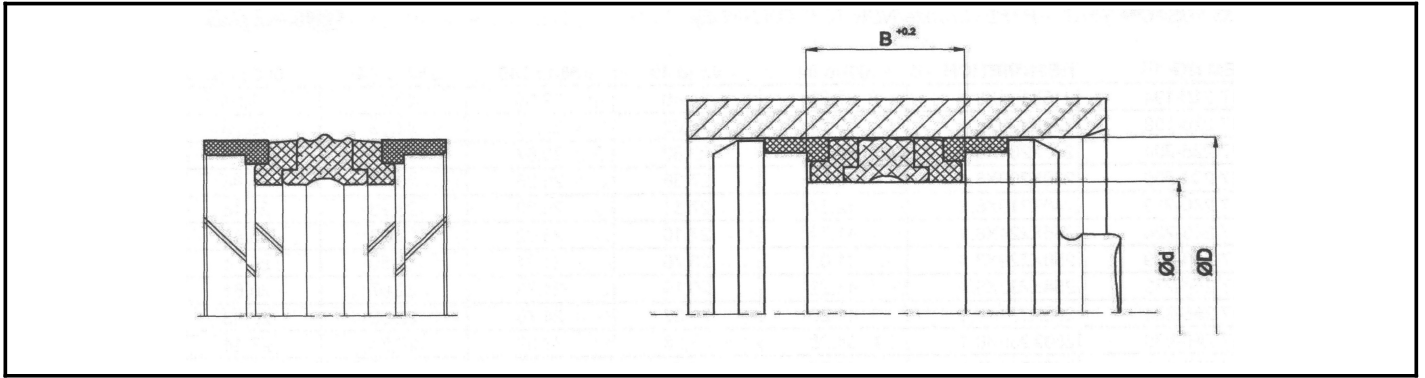

**DTH-PI-1036000-NB-TPP**

**Kompaktkolbendichtung / Compact Piston Seal**

Nummer:	d	D	b	Nummer:	d	D	b
PI-1036000- 0050	25	- 16	- 13,5	PI-1036000- 0180	90	- 70	- 22,4
PI-1036000- 0032	32	- 22	- 16,4	PI-1036000- 0190	95	- 75	- 22,4
PI-1036000- 0070	35	- 25	- 16,4	PI-1036000- 0200	100	- 75	- 22,4
PI-1036000- 0080	40	- 30	- 16,4	PI-1036000- 0220	110	- 85	- 22,4
PI-1036000- 0080-1	40	- 30	- 12,5	PI-1036000- 0240	120	- 95	- 22,4
PI-1036000- 0088	44,45	- 28,57	- 19,05	PI-1036000- 0250	125	- 100	- 25,4
PI-1036000- 0090	45	- 29	- 18,4	PI-1036000- 0260	130	- 105	- 25,4
PI-1036000- 0090-1	45	- 35	- 16,4	PI-1036000- 0260-1	130	- 105	- 25,4/9,52
PI-1036000- 0100	50	- 34	- 20,5	PI-1036000- 0280	140	- 115	- 25,4/9,52
PI-1036000- 0100-1	50	- 34	- 18,4	PI-1036000- 0280-1	140	- 118	- 26,5
PI-1036000- 0100-2	50	- 38	- 20,5	PI-1036000- 0300	150	- 125	- 25,4
PI-1036000- 0110	55	- 39	- 18,4	PI-1036000- 0300-1	150	- 128	- 26,5
PI-1036000- 0120	60	- 44	- 18,4	PI-1036000- 0320	160	- 143	- 26,5
PI-1036000- 0120-1	60	- 48	- 20,5	PI-1036000- 0360	180	- 158	- 26,5
PI-1036000- 0126	63	- 47	- 18,4	PI-1036000- 0360-1	180	- 163	- 26,5
PI-1036000- 0130	65	- 49	- 20,5	PI-1036000- 0400	200	- 175	- 31,5
PI-1036000- 0130-1	65	- 50	- 18,4	PI-1036000- 0400-1	200	- 180	- 31,5
PI-1036000- 0140	70	- 50	- 22,4	PI-1036000- 0420	210	- 185	- 25,4
PI-1036000- 0150	75	- 55	- 22,4	PI-1036000- 0440	220	- 200	- 31,5
PI-1036000- 0160	80	- 60	- 22,4	PI-1036000- 0500	250	- 230	- 31,5
PI-1036000- 0170	85	- 65	- 22,4				

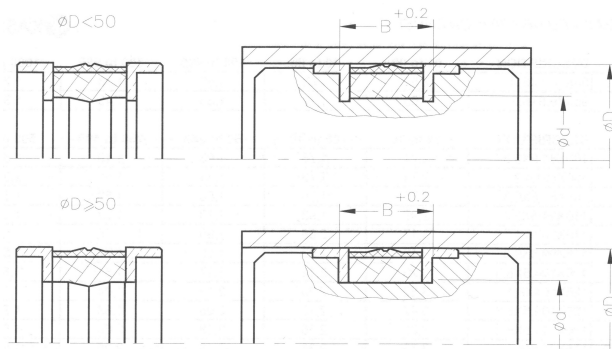

## DTH-PI-32000-NBFP

## Kompaktkolbendichtung / Compact Piston Seal

Nummer:	d	D	b	Nummer:	d	D	b
PI-32000- 0050	25	- 17	- 13,5	PI-32000- 0180	90	- 76	- 22,5
PI-32000- 0060-1	30	- 21	- 13,5	PI-32000- 0200	100	- 86	- 22,5
PI-32000- 0060-2	30	- 22	- 13,5	PI-32000- 0220	110	- 96	- 22,5
PI-32000- 0064	32	- 24	- 15,5	PI-32000- 0230	115	- 101	- 22,5
PI-32000- 0070	35	- 27	- 15,5	PI-32000- 0240	120	- 106	- 22,5
PI-32000- 0080	40	- 32	- 15,5	PI-32000- 0250-1	125	- 103	- 26,5
PI-32000- 0090	45	- 37	- 15,5	PI-32000- 0250-2	125	- 108	- 26,5
PI-32000- 0100	50	- 38	- 20,5	PI-32000- 0280	140	- 123	- 26,5
PI-32000- 0120	60	- 48	- 20,5	PI-32000- 0300	150	- 133	- 26,5
PI-32000- 0126	63	- 51	- 20,5	PI-32000- 0320-1	160	- 140	- 25
PI-32000- 0130	65	- 53	- 20,5	PI-32000- 0320-2	160	- 143	- 26,5
PI-32000- 0140	70	- 58	- 20,5	PI-32000- 0360	180	- 163	- 26,5
PI-32000- 0150	75	- 63	- 20,5	PI-32000- 0400	200	- 180	- 31,5
PI-32000- 0160	80	- 65	- 20	PI-32000- 0440	220	- 200	- 31,5
PI-32000- 0160	80	- 66	- 22,5	PI-32000- 0500-1	250	- 225	- 31,5
PI-32000- 0170	85	- 71	- 22,5	PI-32000- 0500-2	250	- 230	- 31,5

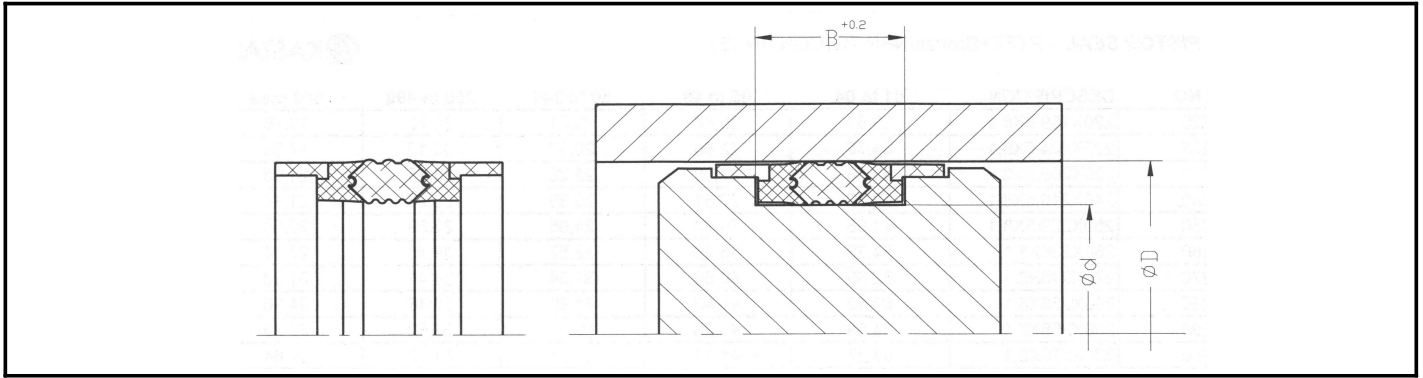

### DTH-PI-84000-NB-TP-POM

### Kompakt Kolbendichtung / Compact Piston Seal

Nummer:	d	D	b	Nummer:	d	D	b
PI-84000- 0100	50	- 34	- 32	PI-84000- 0280	140	- 120	- 35
PI-84000- 0120	60	- 44	- 32	PI-84000- 0300	150	- 120	- 44
PI-84000- 0126	63	- 47	- 32	PI-84000- 0300-1	150	- 125	- 45
PI-84000- 0140	70	- 50	- 35	PI-84000- 0320	160	- 135	- 45
PI-84000- 0160	80	- 60	- 35	PI-84000- 0340	170	- 140	- 45
PI-84000- 0170	85	- 65	- 35	PI-84000- 0360	180	- 155	- 45
PI-84000- 0180	90	- 70	- 35	PI-84000- 0380	190	- 165	- 45
PI-84000- 0190	95	- 75	- 35	PI-84000- 0400	200	- 175	- 45
PI-84000- 0200	100	- 80	- 35	PI-84000- 0420	210	- 185	- 45
PI-84000- 0220	110	- 90	- 35	PI-84000- 0500	250	- 225	- 45
PI-84000- 0240	120	- 100	- 35	PI-84000- 0560	280	- 255	- 45
PI-84000- 0250	125	- 100	- 45	PI-84000- 0600	300	- 275	- 45
PI-84000- 0260	130	- 110	- 35				

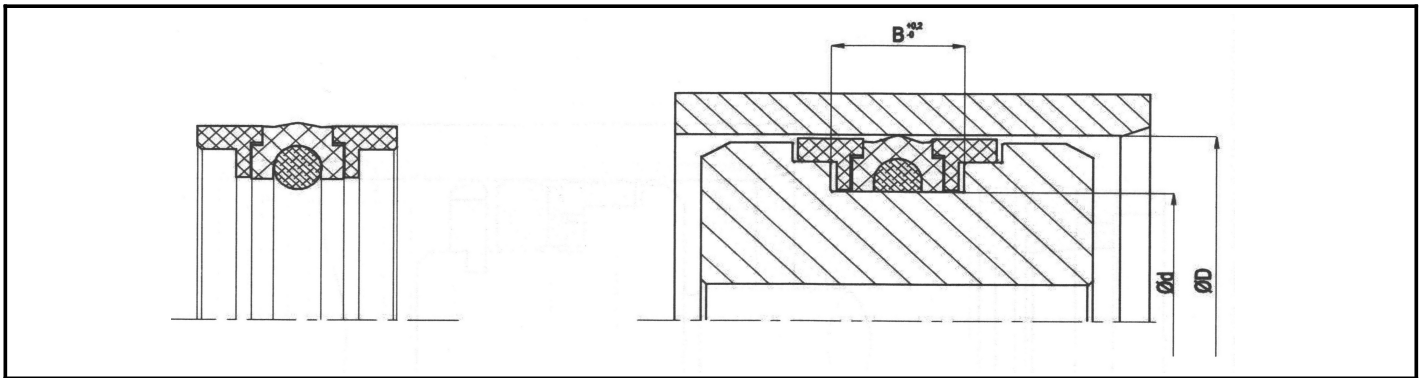

### DTH-PI-92000-PU-POM-NB

### Kompakt Kolbendichtung / Compact Piston Seal

Nummer:	d	D	b	Nummer:	d	D	b
PI-92000- 0050	25	- 17	- 10/4	PI-92000- 0140	70	- 60	- 12,5/4
PI-92000- 0064	32	- 24	- 10/4	PI-92000- 0160	80	- 70	- 11 /4
PI-92000- 0080	40	- 30	- 11/4	PI-92000- 0160-1	80	- 70	- 12,5/4
PI-92000- 0080-1	40	- 30	- 10/5	PI-92000- 0180	90	- 80	- 12,5/4
PI-92000- 0100	50	- 40	- 11/4	PI-92000- 0200	100	- 90	- 12,5/4
PI-92000- 0126	63	- 53	- 11/4	PI-92000- 0202	101,6	- 88,9	- 14,47/5,43

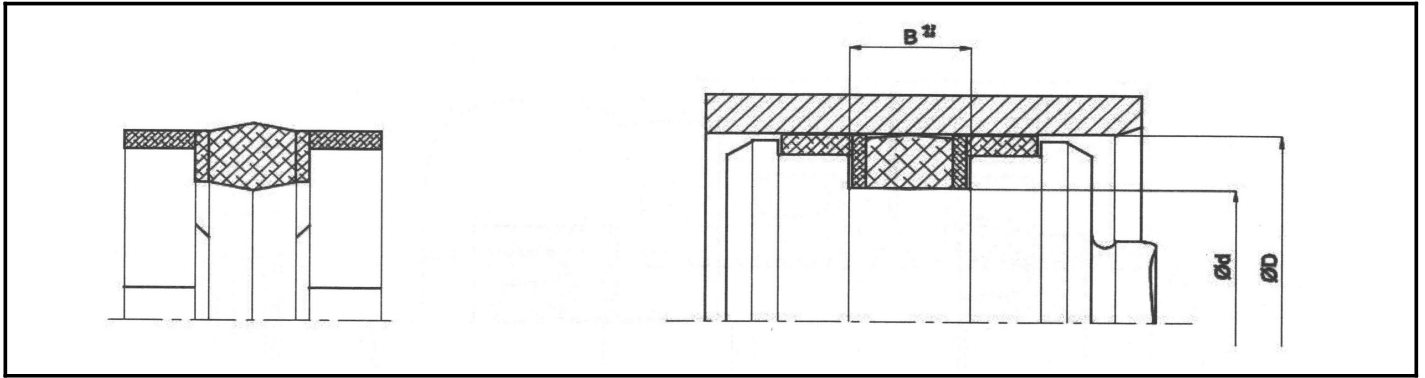

**DTH-PI-1006-NB-TPE-POM**

**Kompakt Kolbendichtung / Compact Piston Seal**

Nummer:	d	D	b	Nummer:	d	D	b
PI-1006-0056	28,57	- 19,05	- 11,1	PI-1006-0152-1	76,1	- 63,5	- 14,53
PI-1006-0062	31,75	- 22,22	- 11,1	PI-1006-0164	82,55	- 69,85	- 14,53
PI-1006-0068	34,92	- 25,4	- 11,1	PI-1006-0176	88,9	- 76,2	- 14,52/6,35
PI-1006-0076	38,1	- 28,57	- 11,1	PI-1006-0176-1	88,9	- 76,2	- 14,52
PI-1006-0076-1	38,1	- 28,57	- 11,1	PI-1006-0190	95,25	- 82,55	- 14,52
PI-1006-0082	41,27	- 31,75	- 11,09	PI-1006-0202	101,6	- 82,55	- 19,43/6,35
PI-1006-0088	44,45	- 34,92	- 11,11	PI-1006-0202-1	101,6	- 82,55	- 19,43
PI-1006-0100	50,8	- 38,1	- 14,52/6,35	PI-1006-0214	107,95	- 88,9	- 19,43
PI-1006-0100-1	50,8	- 38,1	- 14,52	PI-1006-0228	114,3	- 95,25	- 19,43
PI-1006-0114	57,15	- 44,45	- 14,52	PI-1006-0240	120,65	- 101,6	- 19,43
PI-1006-0114-1	57,15	- 44,45	- 14,52	PI-1006-0254	127	- 107,95	- 19,43
PI-1006-0126	63,5	- 50,8	- 14,52/6,35	PI-1006-0278	139,7	- 120,65	- 19,43
PI-1006-0126-1	63,5	- 50,8	- 14,52	PI-1006-0304	152,4	- 133,35	- 19,43
PI-1006-0138	69,85	- 57,15	- 14,53	PI-1006-0354	177,8	- 158,75	- 19,43
PI-1006-0152	76,1	- 63,5	- 14,53/6,35	PI-1006-0406	203,2	- 184,15	- 19,43

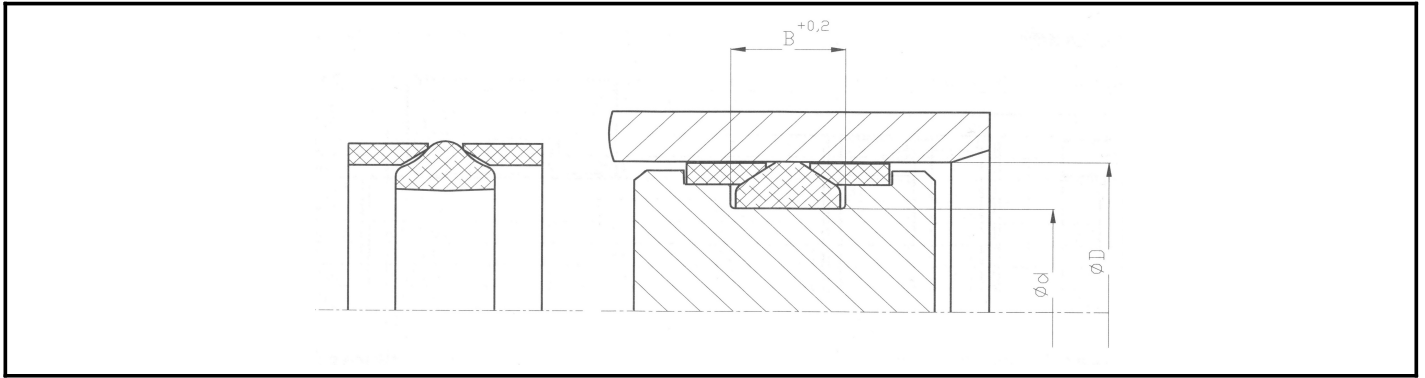

**DTH-PI-40000-NB-POM**

**Kompakt Kolbendichtung / Compact Piston Seal**

Nummer:	d	D	b	Nummer:	d	D	b
PI-40000- 0050	25	- 17,5	- 8,5	PI-40000- 0200	100	- 87	- 14
PI-40000- 0064	32	- 22	- 11	PI-40000- 0250	125	- 112	- 14
PI-40000- 0080	40	- 30	- 11	PI-40000- 0280	140	- 124	- 17,5
PI-40000- 0100	50	- 40	- 11	PI-40000- 0320	160	- 140	- 25
PI-40000- 0126	63	- 53	- 11	PI-40000- 0360	180	- 160	- 25
PI-40000- 0160	80	- 70	- 11	PI-40000- 0400	200	- 180	- 25
PI-40000- 0184	92	- 82	- 11				



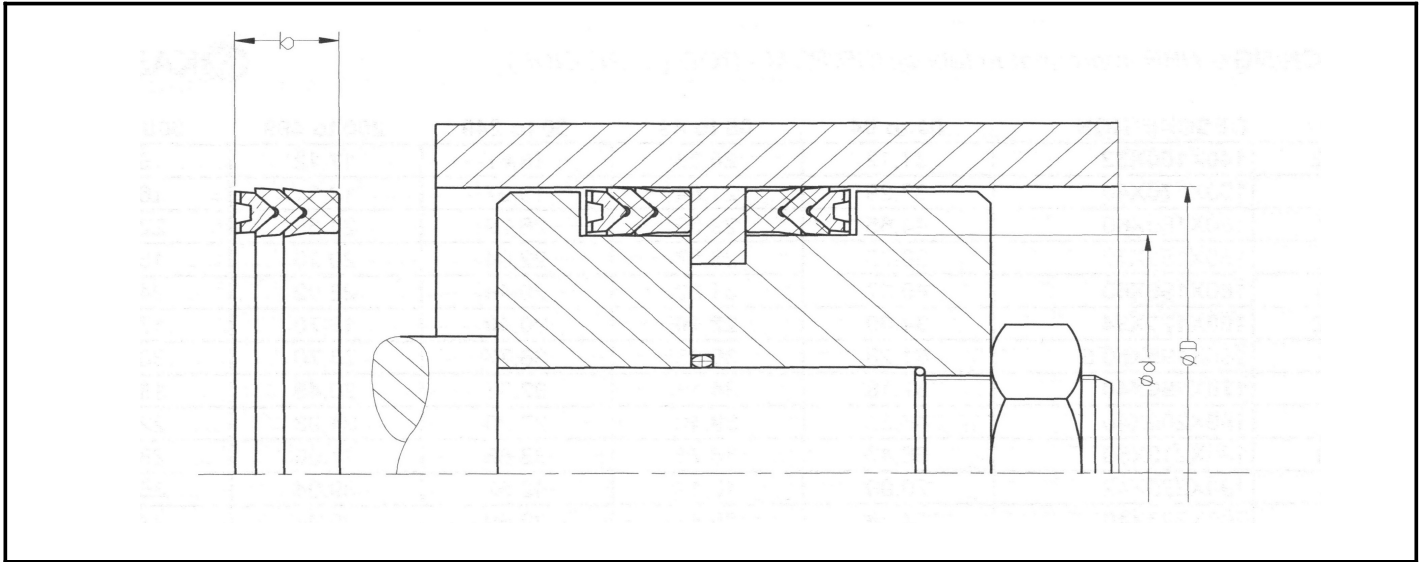

**DTH-PI-6000-NB-FA-POM**

**Kolben Dachmanschettensatz / Piston Packing**

Nummer:	d		D		b	Nummer:	d		D		b
PI-6000 - 0040	20	-	10	-	8,5	PI-6000 - 0140	70	-	50	-	14,6
PI-6000 - 0044	22	-	12	-	8,9	PI-6000 - 0160	80	-	60	-	14,6
PI-6000 - 0050	25	-	15	-	8,9	PI-6000 - 0180	90	-	70	-	20,6
PI-6000 - 0056	28	-	18	-	8,9	PI-6000 - 0200	100	-	80	-	20,6
PI-6000 - 0060	30	-	20	-	8,9	PI-6000 - 0220	110	-	90	-	20,6
PI-6000 - 0064	32	-	20	-	10,4	PI-6000 - 0230	115	-	95	-	20,6
PI-6000 - 0070	35	-	23	-	10,4	PI-6000 - 0250	125	-	100	-	25
PI-6000 - 0072	36	-	24	-	10,4	PI-6000 - 0280	140	-	115	-	25
PI-6000 - 0080	40	-	25	-	11	PI-6000 - 0300	150	-	120	-	28
PI-6000 - 0084	42	-	27	-	11	PI-6000 - 0320	160	-	130	-	28
PI-6000 - 0090	45	-	30	-	11	PI-6000 - 0360	180	-	150	-	30,5
PI-6000 - 0100	50	-	35	-	11	PI-6000 - 0400	200	-	170	-	32,5
PI-6000 - 0110	55	-	40	-	11	PI-6000 - 0500	250	-	220	-	32,5
PI-6000 - 0112	56	-	41	-	11	PI-6000 - 0550	275	-	245	-	32,5
PI-6000 - 0120	60	-	45	-	11	PI-6000 - 0560	280	-	250	-	32,5
PI-6000 - 0126	63	-	48	-	12,5	PI-6000 - 0600	300	-	270	-	32,5

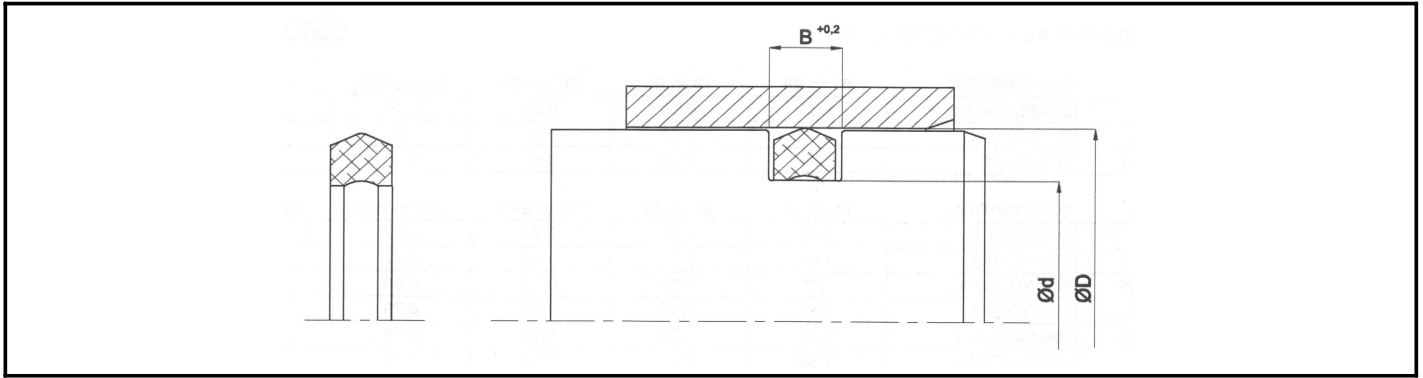

## DTH-COV-168000-PU

## Cover Dichtung / Cover Seal

Nummer:	d	D	b	Nummer:	d	D	b
COV-168000- 0028	14	- 11	- 2,6	COV-168000- 0170	85	- 80,8	- 5
COV-168000- 0032	16	- 13	- 2,6	COV-168000- 0176	88	- 83,4	- 4
COV-168000- 0034	17	- 14	- 3,5	COV-168000- 0180	90	- 80,1	- 7,8
COV-168000- 0038	19	- 16	- 3,5	COV-168000- 0180-1	90	- 84,5	- 4,5
COV-168000- 0052	26	- 21,4	- 3,9	COV-168000- 0182	91	- 85,6	- 4,5
COV-168000- 0060	30	- 25,4	- 3,9	COV-168000- 0190	95,5	- 87,7	- 5
COV-168000- 0064	32	- 27,4	- 3,9	COV-168000- 0190-1	95	- 86,4	- 9
COV-168000- 0064-1	32	- 28	- 3,4	COV-168000- 0200	100	- 90	- 7,8
COV-168000- 0066	33	- 29,2	- 3,2	COV-168000- 0200-1	100	- 91,4	- 9
COV-168000- 0080	40	- 33,5	- 4,8	COV-168000- 0200-2	100	- 93,7	- 3,2
COV-168000- 0080-1	40	- 32,8	- 3,4	COV-168000- 0200-3	100	- 90,3	- 9
COV-168000- 0080-2	40	- 36	- 3,4	COV-168000- 0200-4	100	- 90,2	- 9,4
COV-168000- 0082	41	- 37	- 3,4	COV-168000- 0202	101	- 94,7	- 5,2
COV-168000- 0084	42,5	- 37,5	- 3,7	COV-168000- 0210	105	- 95,1	- 7,8
COV-168000- 0090	45	- 39,5	- 4,5	COV-168000- 0220	110	- 101,4	- 9
COV-168000- 0100	50	- 44,4	- 6,2	COV-168000- 0220-1	110	- 103,7	- 5,2
COV-168000- 0100-1	50	- 44,4	- 4,8	COV-168000- 0232	116	- 109,7	- 5,2
COV-168000- 0100-2	50	- 45,4	- 3,9	COV-168000- 0242	121	- 115,5	- 4,5
COV-168000- 0102	51	- 46,4	- 3,9	COV-168000- 0250	125	- 116,4	- 9
COV-168000- 0112	56	- 51,4	- 3,9	COV-168000- 0250-1	125	- 118,7	- 5,2
COV-168000- 0120	60	- 52,2	- 5,8	COV-168000- 0256	128	- 122,6	- 4,5
COV-168000- 0120-1	60	- 53,7	- 5,2	COV-168000- 0260	130	- 123,7	- 5,2
COV-168000- 0122	61	- 55,5	- 4,5	COV-168000- 0280	140	- 134,1	- 5,9
COV-168000- 0126	63	- 57,4	- 6,2	COV-168000- 0280-1	140	- 133,7	- 5,2
COV-168000- 0126-1	63	- 57,5	- 4,5	COV-168000- 0300	150	- 141,9	- 9,2
COV-168000- 0128	64	- 58,5	- 4,5	COV-168000- 0300-1	150	- 143,7	- 5,2
COV-168000- 0130	65	- 57,2	- 5,8	COV-168000- 0300-2	150	- 140,7	- 9,5
COV-168000- 0132	66	- 60,5	- 4,5	COV-168000- 0320	160	- 150	- 8,4
COV-168000- 0140	70	- 64,4	- 6,2	COV-168000- 0320-1	160	- 153,7	- 5,2
COV-168000- 0140-1	70	- 64,5	- 4,5	COV-168000- 0324	162	- 154	- 8,2
COV-168000- 0142	71	- 65,5	- 4,5	COV-168000- 0330	165	- 155	- 8,4
COV-168000- 0150	75	- 69,6	- 6,5	COV-168000- 0340	170	- 160	- 8,4
COV-168000- 0152	76	- 70,5	- 4,5	COV-168000- 0350	175	- 165	- 8,4
COV-168000- 0160	80	- 74,6	- 6,5	COV-168000- 0360	180	- 170	- 8,4
COV-168000- 0160-1	80	- 74,5	- 4,5	COV-168000- 0360-1	180	- 171,4	- 6,9
COV-168000- 0162	81	- 73,2	- 5	COV-168000- 0370	185	- 175	- 8,4
COV-168000- 0162-1	81	- 75,5	- 4,5	COV-168000- 0380	190	- 180	- 8,4

**DTH-COV-168000-PU****Cover Dichtung / Cover Seal**

Nummer:	d	D	b	Nummer:	d	D	b
COV-168000- 0390	195	- 185	- 8,4	COV-168000- 0460	230	- 220	- 8,4
COV-168000- 0400	200	- 191,4	- 9	COV-168000- 0470	235	- 225	- 8,4
COV-168000- 0400-1	200	- 190	- 8,4	COV-168000- 0500	250	- 238,4	- 12,3
COV-168000- 0400-2	200	- 191,4	- 6,9	COV-168000- 0510	255	- 240	- 12,9
COV-168000- 0400-3	200	- 191	- 9,3	COV-168000- 0550	275	- 263,4	- 12,3
COV-168000- 0410	205	- 195	- 8,4	COV-168000- 0600	300	- 283	- 16,3
COV-168000- 0420	210	- 200	- 8,4	COV-168000- 0610	305	- 290	- 12,9
COV-168000- 0430	215	- 205	- 8,4	COV-168000- 0700	350	- 333	- 16,3
COV-168000- 0440	220	- 210	- 8,4	COV-168000- 0710	355	- 340	- 12,9
COV-168000- 0450	225	- 215	- 8,4				

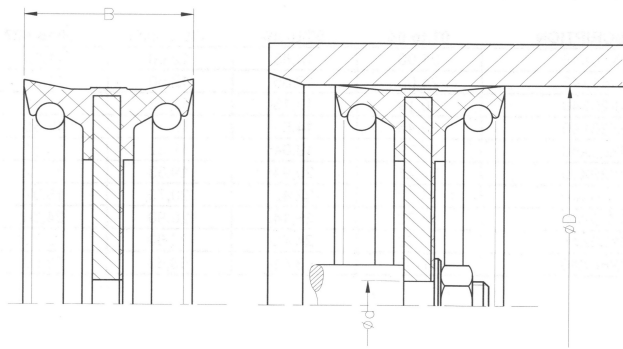

**DTH-PI-52000-NB-MET / 80**

**Hydraulik Kolbendichtung / Hydraulic Piston Seal**

Nummer:	d	D	b	Nummer:	d	D	b
PI-52000-80 0050	25	- 8	- 22	PI-52000-80 0160	80	- 12	- 30
PI-52000-80 0052	26	- 8	- 22	PI-52000-80 0164	82	- 12,2	- 30
PI-52000-80 0060	30	- 8	- 22	PI-52000-80 0170-1	85	- 12	- 35
PI-52000-80 0064	32	- 8	- 25	PI-52000-80 0180	90	- 12	- 35
PI-52000-80 0070	35	- 8	- 26	PI-52000-80 0200	100	- 12	- 35
PI-52000-80 0070-1	35	- 8	- 18	PI-52000-80 0220	110	- 12	- 40
PI-52000-80 0076	38	- 8	- 25	PI-52000-80 0240	120	- 20	- 40
PI-52000-80 0080-1	40	- 14	- 23	PI-52000-80 0250	125	- 20	- 40
PI-52000-80 0080-2	40	- 10	- 25	PI-52000-80 0250-1	125	- 30	- 40
PI-52000-80 0090	45	- 10	- 25	PI-52000-80 0250-2	125	- 30	- 50
PI-52000-80 0100	50	- 10	- 25	PI-52000-80 0260	130	- 20	- 40
PI-52000-80 0100-1	50	- 16	- 23	PI-52000-80 0280	140	- 20	- 40
PI-52000-80 0110	55	- 10	- 25	PI-52000-80 0290	145	- 20	- 45
PI-52000-80 0120	60	- 12	- 26	PI-52000-80 0290-1	145	- 41	- 45
PI-52000-80 0120-1	60	- 21	- 26	PI-52000-80 0300	150	- 20	- 40
PI-52000-80 0120-2	60	- 12	- 27	PI-52000-80 0320	160	- 20	- 40
PI-52000-80 0120-3	60	- 18	- 26	PI-52000-80 0350	175	- 20	- 40
PI-52000-80 0124	62	- 41	- 30	PI-52000-80 0360	180	- 20	- 40
PI-52000-80 0126	63	- 12	- 25	PI-52000-80 0400	200	- 20	- 40
PI-52000-80 0130	65	- 12	- 25	PI-52000-80 0460	230	- 30	- 40
PI-52000-80 0140	70	- 12	- 30	PI-52000-80 0500	250	- 30	- 40
PI-52000-80 0150	75	- 12	- 30	PI-52000-80 0600	300	- 60	- 40

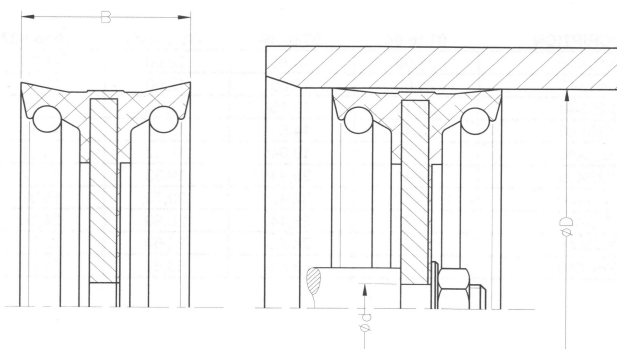

**DTH-PI-52000-NB-MET / 90**

**Hydraulik Kolbendichtung / Hydraulic Piston Seal**

Nummer:	d	D	b	Nummer:	d	D	b
PI-52000-90 0050	25	- 8	- 22	PI-52000-90 0170	85	- 12	- 35
PI-52000-90 0052	26	- 8	- 22	PI-52000-90 0170-1	85	- 12	- 35
PI-52000-90 0060	30	- 8	- 22	PI-52000-90 0180	90	- 12	- 35
PI-52000-90 0064	32	- 8	- 25	PI-52000-90 0200	100	- 12	- 35
PI-52000-90 0070	35	- 8	- 26	PI-52000-90 0220	110	- 12	- 40
PI-52000-90 0070-1	35	- 8	- 18	PI-52000-90 0240	120	- 20	- 40
PI-52000-90 0076	38	- 8	- 25	PI-52000-90 0250	125	- 20	- 40
PI-52000-90 0080	40	- 10	- 25	PI-52000-90 0250-1	125	- 30	- 40
PI-52000-90 0080-1	40	- 14	- 23	PI-52000-90 0250-2	125	- 30	- 50
PI-52000-90 0080-2	40	- 10	- 25	PI-52000-90 0260	130	- 20	- 40
PI-52000-90 0090	45	- 10	- 25	PI-52000-90 0280	140	- 20	- 40
PI-52000-90 0092	46	- 10	- 25	PI-52000-90 0290	145	- 20	- 45
PI-52000-90 0100	50	- 10	- 25	PI-52000-90 0290-1	145	- 41	- 45
PI-52000-90 0100-1	50	- 16	- 23	PI-52000-90 0300	150	- 20	- 40
PI-52000-90 0110	55	- 10	- 25	PI-52000-90 0320	160	- 20	- 40
PI-52000-90 0120-2	60	- 12	- 27	PI-52000-90 0350	175	- 20	- 40
PI-52000-90 0120-1	60	- 21	- 26	PI-52000-90 0360	180	- 20	- 40
PI-52000-90 0120	60	- 12	- 26	PI-52000-90 0400	200	- 20	- 40
PI-52000-90 0124	62	- 41	- 30	PI-52000-90 0400-1	200	- 20,2	- 40
PI-52000-90 0126	63	- 12	- 25	PI-52000-90 0460	230	- 30	- 40
PI-52000-90 0130	65	- 12	- 25	PI-52000-90 0500	250	- 30	- 40
PI-52000-90 0140	70	- 12	- 30	PI-52000-90 0600	300	- 60	- 40
PI-52000-90 0150	75	- 12	- 30	PI-52000-90 0700	350	- 22	- 50
PI-52000-90 0160	80	- 12	- 30				

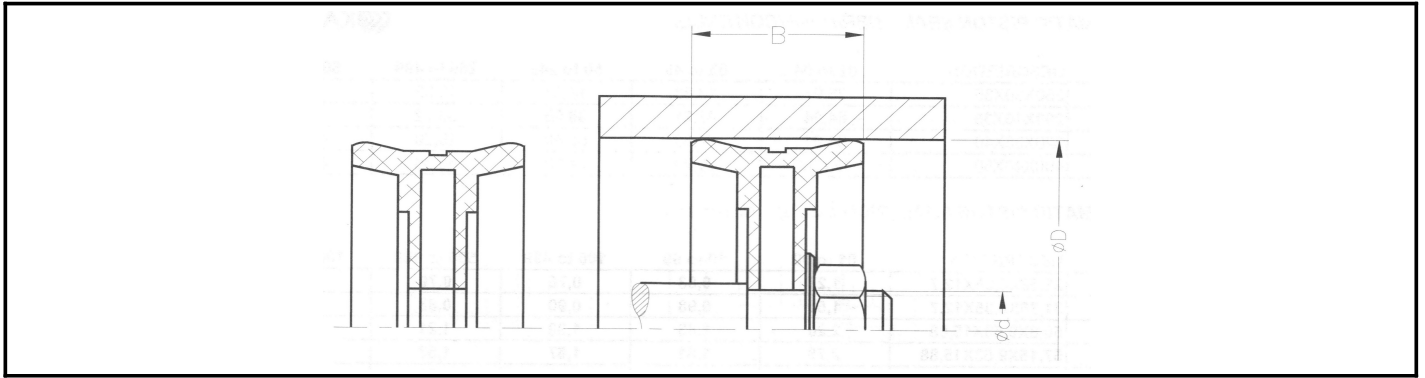

### DTH-PI-50000-NB-MET

### Pneumatik Kolbendichtung / Pneumatic Piston Seal

Nummer:	d	D	b	Nummer:	d	D	b
PI-50000 0040	20	- 5,2	- 8	PI-50000 0200-4	100	- 12	- 25
PI-50000 0050	25	- 8	- 12	PI-50000 0200-6	100	- 20	- 26
PI-50000 0052	26	- 8	- 12	PI-50000 0204	102	- 16	- 25
PI-50000 0064	32	- 8	- 15	PI-50000 0220	110	- 18	- 25
PI-50000 0070	35	- 8	- 15	PI-50000 0250	125	- 20	- 30
PI-50000 0072	36	- 8	- 15	PI-50000 0250-1	125	- 20	- 26
PI-50000 0080	40	- 10	- 18	PI-50000 0254	127	- 19,05	- 25,4
PI-50000 0100	50	- 10	- 18	PI-50000 0280	140	- 20	- 30
PI-50000 0100-2	50	- 16	- 20,5	PI-50000 0300	150	- 20	- 30
PI-50000 0120	60	- 12	- 22	PI-50000 0320	160	- 27	- 31
PI-50000 0124	62	- 15	- 22	PI-50000 0320-3	160	- 20	- 30
PI-50000 0126	63	- 12	- 22	PI-50000 0360	180	- 27	- 31
PI-50000 0140	70	- 12	- 22	PI-50000 0380	190	- 20	- 30
PI-50000 0150	75	- 15	- 22	PI-50000 0380-1	190	- 12	- 35
PI-50000 0150-1	75	- 12	- 22,5	PI-50000 0400	200	- 27	- 35
PI-50000 0160	80	- 16	- 25	PI-50000 0400-2	200	- 20	- 35
PI-50000 0160-3	80	- 12	- 25	PI-50000 0500	250	- 30	- 35
PI-50000 0160-4	80	- 16	- 22,5	PI-50000 0520	260	- 16	- 35
PI-50000 0180	90	- 16	- 25	PI-50000 0640	320	- 36	- 40
PI-50000 0200	100	- 16	- 25	PI-50000 0800	400	- 40	- 40
PI-50000 0200-1	100	- 20	- 25				

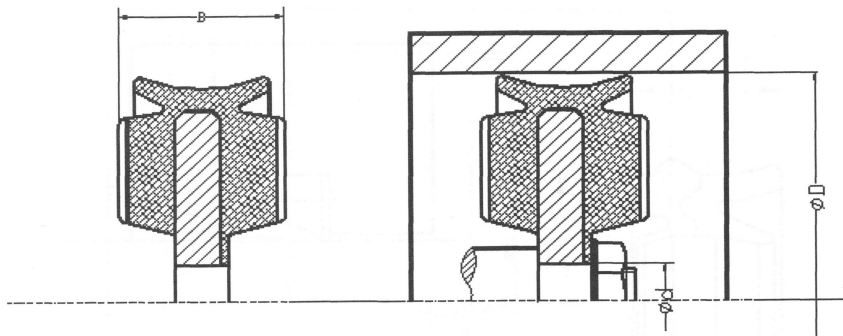

### DTH-PI-114000-NB-ALU

### Pneumatik Komplettkolben / Pneumatic Piston Seal

Nummer:	d	D	b	Nummer:	d	D	b
PI-114000-0020	10	- 3	- 5	PI-114000-0080	40	- 8	- 11,8
PI-114000-0024	12	- 4,5	- 6	PI-114000-0100	50	- 10	- 14
PI-114000-0032	16	- 4,5	- 6,5	PI-114000-0126	63	- 12	- 14
PI-114000-0040	20	- 6	- 6,3	PI-114000-0160	80	- 16	- 16
PI-114000-0050	25	- 7	- 8,8	PI-114000-0200	100	- 20	- 18
PI-114000-0064	32	- 8	- 11				

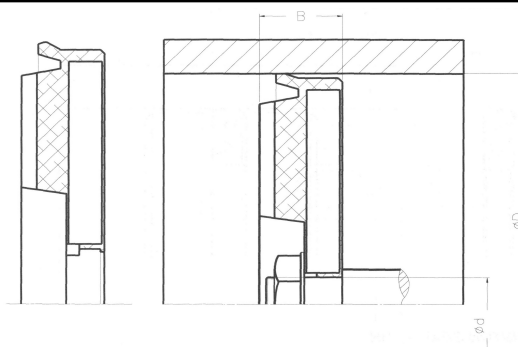

### DTH-PI-110000-NB-ALU

### Pneumatik Kolbendichtung / Pneumatic Piston Seal

Nummer:	d	D	b	Nummer:	d	D	b
PI-110000-0032	16	- 4,5	- 4,4	PI-110000-0100	50	- 10	- 10
PI-110000-0040	20	- 6	- 5,5	PI-110000-0126	63	- 12	- 10
PI-110000-0050	25	- 7	- 6,4	PI-110000-0160	80	- 16	- 11,4
PI-110000-0064	32	- 8	- 7,5	PI-110000-0200	100	- 20	- 12,9
PI-110000-0080	40	- 8	- 8,5				

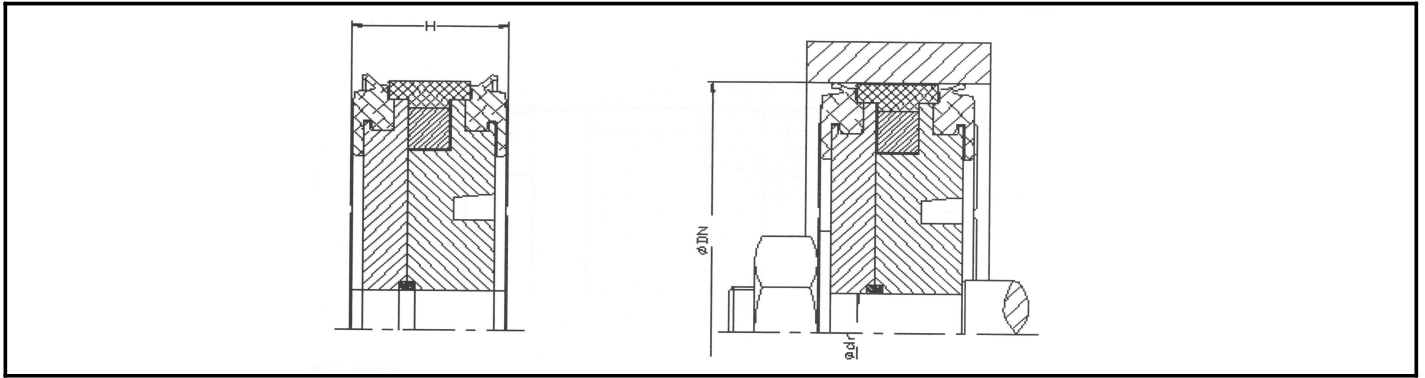

**DTH-PI-116000-PU-POM-ALU-MAG**

**Pneumatik Kolbendichtsatz / Pneumatic Piston Seal**

Nummer:	d	D	b	Nummer:	d	D	b
PI-116000-0064	32	- 8,1	- 14	PI-116000-0126	63	- 10,1	- 19
PI-116000-0080	40	- 8,1	- 15	PI-116000-0160	80	- 12,1	- 21,5
PI-116000-0100	50	- 10,1	- 15,5	PI-116000-0200	100	- 17,1	- 25,5

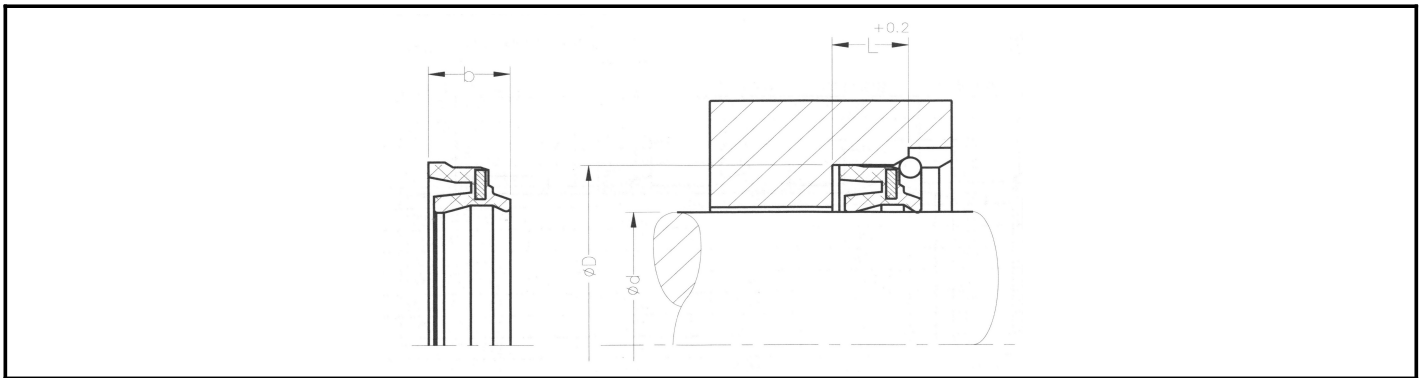

**DTH-RO-60000-NB-MET**

**Pneumatik Kombi Dichtung / Pneumatic Combi Seal**

Nummer:	d	D	b	Nummer:	d	D	b
RO-600000020	10	- 17	- 7/9,5	RO-600000050	25	- 35	- 7/9,5
RO-600000024	12	- 22	- 7/9,5	RO-600000060	30	- 40	- 7/9,5
RO-600000024-1	12	- 20	- 6/8,5	RO-600000064	32	- 42	- 7/9,5
RO-600000028	14	- 24	- 7/9,5	RO-600000070	35	- 45	- 7/9,5
RO-600000032	16	- 26	- 7/9,5	RO-600000080	40	- 50	- 7/9,5
RO-600000036	18	- 26	- 6/8,5	RO-600000090	45	- 55	- 7,3/9,2
RO-600000040	20	- 30	- 7/9,5	RO-600000100	50	- 60	- 7/9,5
RO-600000044	22	- 32	- 7/9,5				



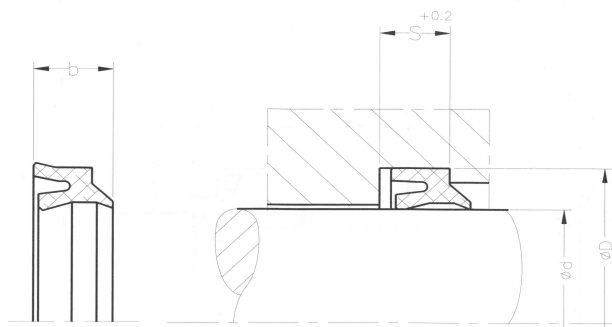

### DTH-00-104000-NB

### Pneumatik Kombi Dichtung / Pneumatic Combi Seal

Nummer:	d	D	b	Nummer:	d	D	b
PI-104000-NB 0008	4	- 8,2	- 2,6/4	PI-104000-NB 0020	10	- 16,2	- 4 /5,5
PI-104000-NB 0012	6	- 11,2	- 3,6/5	PI-104000-NB 0024	12	- 16,5	- 3,7/4
PI-104000-NB 0016	8	- 14,2	- 3,6/5	PI-104000-NB 0032	16	- 20,5	- 3,7/4

### DTH-00-104000-PU

### Pneumatik Kombi Dichtung / Pneumatic Combi Seal

Nummer:	d	D	b	Nummer:	d	D	b
PI-104000-PU 0008	4	- 8,2	- 2,6/4	PI-104000-PU 0032	16	- 20,5	- 3,7/4
PI-104000-PU 0012	6	- 11,2	- 3,6/5	PI-104000-PU 0036	18	- 22,5	- 3,7/4
PI-104000-PU 0016	8	- 14,2	- 3,6/5	PI-104000-PU 0040	20	- 25	- 4,15/4,6
PI-104000-PU 0020	10	- 16,2	- 4 /5,5	PI-104000-PU 0050	25	- 30	- 4,15/4,6
PI-104000-PU 0020-1	10	- 14	- 3,4/3,7	PI-104000-PU 0060	30	- 35,5	- 4,15/5
PI-104000-PU 0024	12	- 16,5	- 3,7/4				

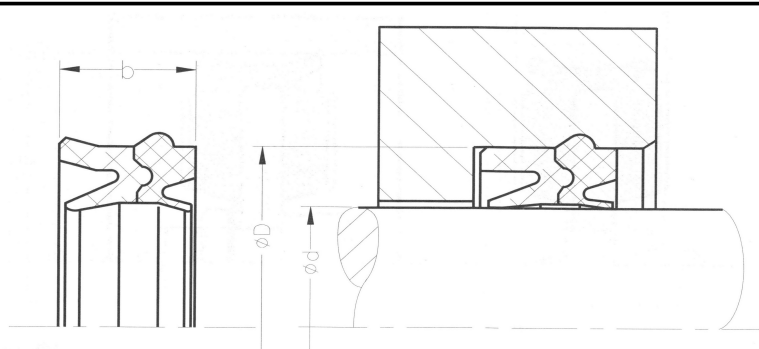

**DTH-00-112000-NB-TPE**

**Pneumatik Dicht-Abstreif-Satz / Pneumatic Rod Seal**

Nummer:	d	D	b	Nummer:	d	D	b
00-112000-0024	12	- 22	- 10,4	00-112000-0064	32	- 42	- 11
00-112000-0028	14	- 24	- 7	00-112000-0070	35	- 45	- 11,5
00-112000-0032	16	- 26	- 10,4	00-112000-0080	40	- 50	- 11
00-112000-0036	18	- 28	- 11	00-112000-0090	45	- 55	- 11,5
00-112000-0040	20	- 30	- 10,4	00-112000-0100	50	- 60	- 11,5
00-112000-0050	25	- 35	- 11	00-112000-0126	63	- 75	- 13
00-112000-0060	30	- 40	- 11,5				

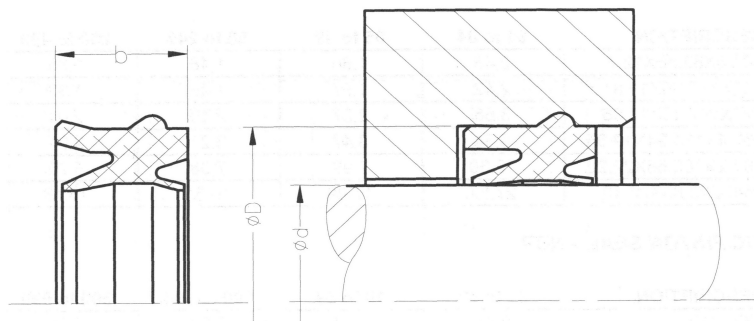

**DTH-RO-102000-PU**

**Pneumatik Kombi Dichtung / Pneumatic Rod Seal**

Nummer:	d	D	b	Nummer:	d	D	b
RO-1020000016	8	- 14	- 7	RO-1020000044	22	- 32	- 11,2
RO-1020000020	10	- 16	- 7	RO-1020000050	25	- 35	- 10,4
RO-1020000024	12	- 22	- 10,4	RO-1020000060	30	- 40	- 11,2
RO-1020000024-1	12	- 20	- 10,4	RO-1020000064	32	- 42	- 10,4
RO-1020000032	16	- 26	- 10,4	RO-1020000080	40	- 50	- 10,4
RO-1020000036	18	- 28	- 10,4	RO-1020000090	45	- 55	- 10,4
RO-1020000036-1	18	- 26	- 10,4	RO-1020000100	50	- 60	- 10,4
RO-1020000040	20	- 30	- 10,4				

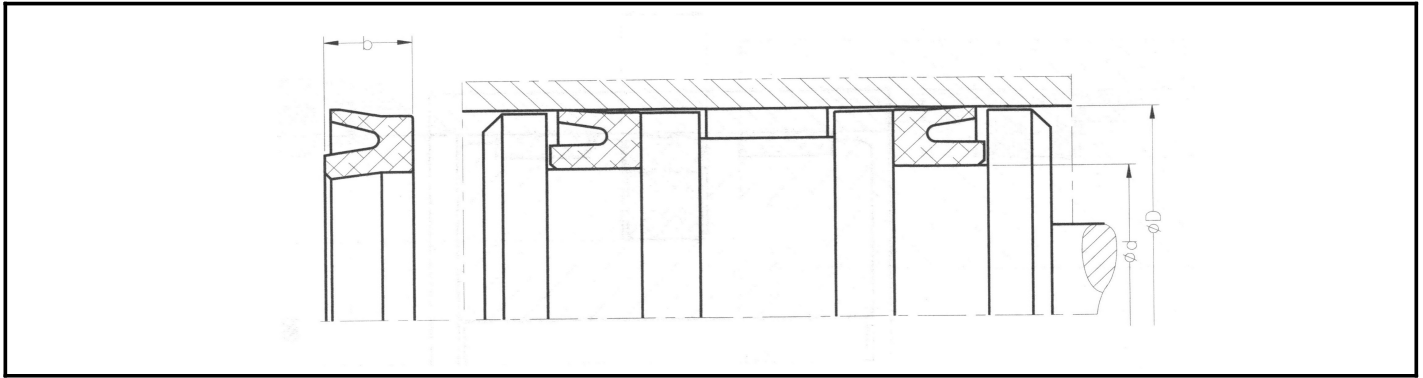

### DTH-PI-100000-PU

### Pneumatik Kolbendichtung / Pneumatic Piston Seal

Nummer:	d	D	b	Nummer:	d	D	b
PI-100000-PU 0032	16	- 10	- 3	PI-100000-PU 0250	125	- 110	- 10
PI-100000-PU 0064	32	- 24	- 5,5	PI-100000-PU 0250-1	125	- 105	- 8,25
PI-100000-PU 0080	40	- 30	- 7	PI-100000-PU 0316	158	- 146	- 8,5
PI-100000-PU 0084	42	- 30	- 10	PI-100000-PU 0320	160	- 140	- 14
PI-100000-PU 0100	50	- 40	- 7	PI-100000-PU 0320-1	160	- 140	- 8,25
PI-100000-PU 0100-1	50	- 36	- 7	PI-100000-PU 0320-2	160	- 145	- 10
PI-100000-PU 0126	63	- 53	- 7	PI-100000-PU 0360	180	- 160	- 12
PI-100000-PU 0160	80	- 68	- 8,5	PI-100000-PU 0400	200	- 180	- 14
PI-100000-PU 0160-2	80	- 67,3	- 6,35	PI-100000-PU 0500	250	- 226	- 16
PI-100000-PU 0186	93	- 81	- 8,5	PI-100000-PU 0640	320	- 295	- 17
PI-100000-PU 0200	100	- 88	- 8,5				

### DTH-PI-100000-NB

### Pneumatik Kolbendichtung / Pneumatic Piston Seal

Nummer:	d	D	b	Nummer:	d	D	b
PI-100000-NB 0032	16	- 10	- 3	PI-100000-NB 0126	63	- 53	- 7
PI-100000-NB 0048	24	- 16	- 5,5	PI-100000-NB 0160	80	- 68	- 8,5
PI-100000-NB 0050-1	25	- 17	- 5,5	PI-100000-NB 0200	100	- 88	- 8,5
PI-100000-NB 0064	32	- 24	- 5,5	PI-100000-NB 0230	115	- 100	- 10
PI-100000-NB 0080	40	- 30	- 7	PI-100000-NB 0248	124	- 111,3	- 9,52
PI-100000-NB 0100	50	- 40	- 7	PI-100000-NB 0250	125	- 110	- 10
PI-100000-NB 0100-1	50	- 36	- 7	PI-100000-NB 0320-2	160	- 145	- 10
PI-100000-NB 0120	60	- 47	- 8	PI-100000-NB 0320-3	160	- 148	- 8

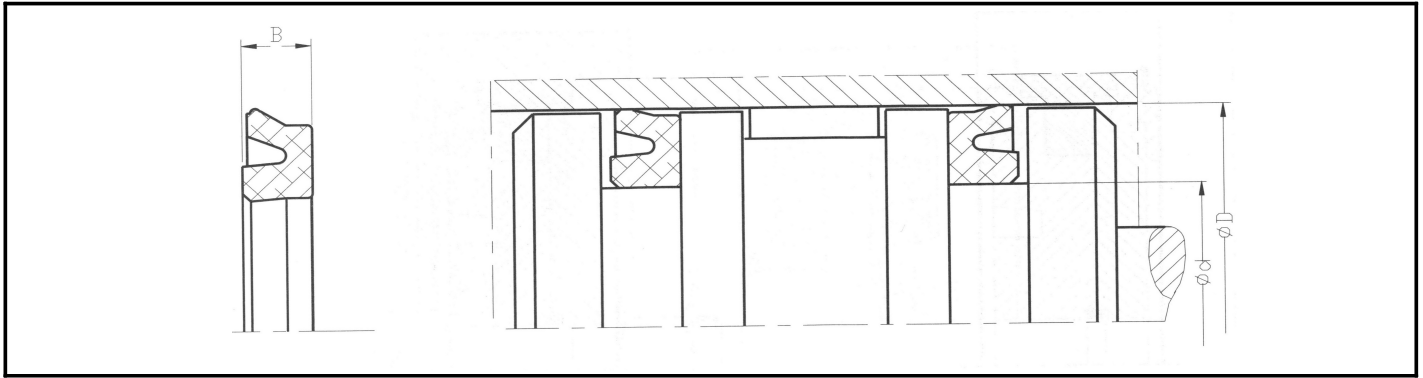

### DTH-PI-118000-NB

### Pneumatik Kolbendichtung / Pneumatic Piston Seal

Nummer:	d	D	b	Nummer:	d	D	b
PI-118000-NB 0016	8	- 4,8	- 2,3	PI-118000-NB 0090	45	- 37	- 3,25
PI-118000-NB 0020	10	- 6	- 2,55	PI-118000-NB 0100	50	- 42	- 3,25
PI-118000-NB 0024	12	- 7	- 2,55	PI-118000-NB 0126	63	- 53	- 4,25
PI-118000-NB 0032	16	- 10	- 2,55	PI-118000-NB 0160	80	- 70	- 4,25
PI-118000-NB 0040	20	- 14	- 2,55	PI-118000-NB 0200	100	- 90	- 4,25
PI-118000-NB 0044	22	- 16	- 2,55	PI-118000-NB 0250-1	125	- 107,5	- 7,25
PI-118000-NB 0048	24	- 18	- 3,25	PI-118000-NB 0320	160	- 140	- 8,25
PI-118000-NB 0050	25	- 19	- 3,25	PI-118000-NB 0400	200	- 182,5	- 7,25
PI-118000-NB 0064	32	- 24	- 3,25	PI-118000-NB 0500	250	- 230	- 8,25
PI-118000-NB 0080	40	- 32	- 3,25	PI-118000-NB 0640	320	- 300	- 8,25

### DTH-PI-118000-PU

### Pneumatik Kolbendichtung / Pneumatic Piston Seal

Nummer:	d	D	b	Nummer:	d	D	b
PI-118000-PU 0024	12	- 7	- 2,55	PI-118000-PU 0100	50	- 42	- 3,25
PI-118000-PU 0032	16	- 10	- 2,55	PI-118000-PU 0126	63	- 53	- 4,25
PI-118000-PU 0040	20	- 14	- 2,55	PI-118000-PU 0160	80	- 70	- 4,25
PI-118000-PU 0050	25	- 19	- 3,25	PI-118000-PU 0200	100	- 90	- 4,25
PI-118000-PU 0064	32	- 24	- 3,25	PI-118000-PU 0250	125	- 105	- 8,25
PI-118000-PU 0080	40	- 32	- 3,25	PI-118000-PU 0320	160	- 140	- 8,25

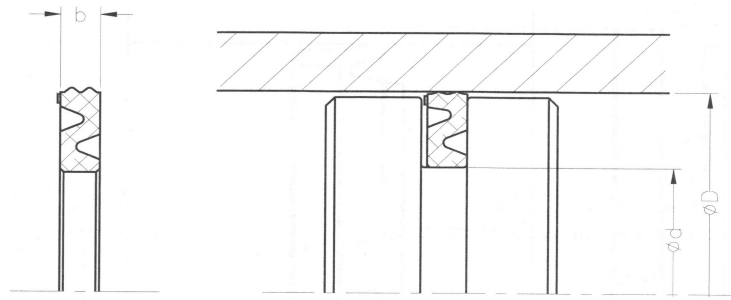

### DTH-PI-108000-NB

### Pneumatik Kolbendichtung / Pneumatic Piston Seal

Nummer:	d	D	b	Nummer:	d	D	b
PI-108000-0024	12	- 7	- 2	PI-108000-0090	45	- 36	- 2,5
PI-108000-0032	16	- 9	- 2,1	PI-108000-0100	50	- 41	- 2,5
PI-108000-0040	20	- 13	- 2,1	PI-108000-0120	60	- 44	- 3,4
PI-108000-0050	25	- 18	- 2,1	PI-108000-0126	63	- 51	- 3,4
PI-108000-0056	28	- 19	- 2,5	PI-108000-0140	70	- 58	- 3,4
PI-108000-0060	30	- 21	- 2,5	PI-108000-0160	80	- 68	- 3,4
PI-108000-0064	32	- 23	- 2,5	PI-108000-0200	100	- 88	- 3,4
PI-108000-0070	35	- 26	- 2,5	PI-108000-0250	125	- 110	- 4,4
PI-108000-0080	40	- 31	- 2,5				

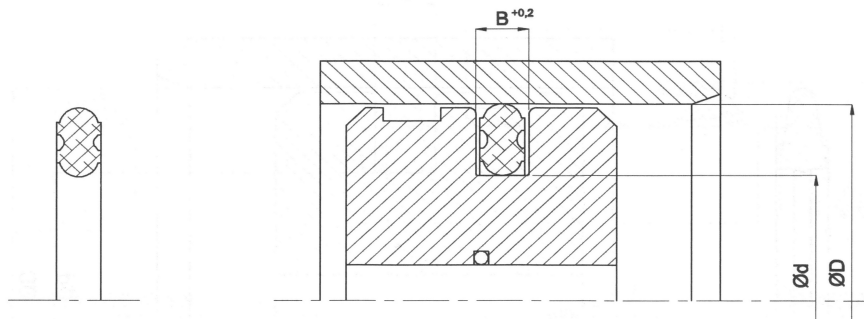

### DTH-PI-124000-NB

### Pneumatik Kolbendichtung / Pneumatic Piston Seal

Nummer:	d	D	b	Nummer:	d	D	b
PI-124000-0064	32	- 24	- 3,2	PI-124000-0126	63	- 53	- 4
PI-124000-0080	40	- 32	- 3,2	PI-124000-0160	80	- 65	- 6
PI-124000-0100	50	- 40	- 4	PI-124000-0200	100	- 85	- 6

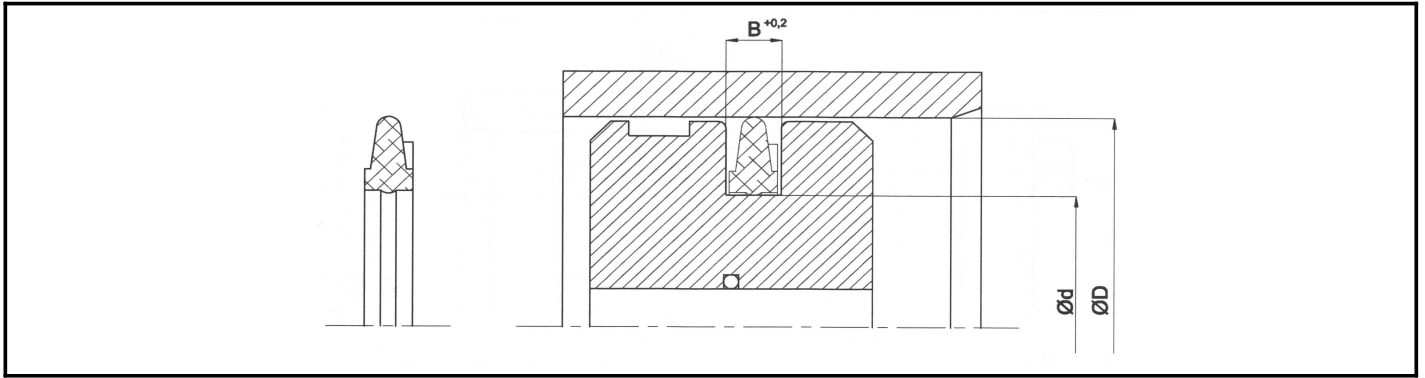

**DTH-PI-126000-NB**

**Pneumatik Kolbendichtung / Pneumatic Piston Seal**

Nummer:	d	D	b	Nummer:	d	D	b
PI-126000-0024	12	- 7,4	- 1,8	PI-126000-0040	20	- 14	- 2,4
PI-126000-0032	16	- 11,4	- 1,8	PI-126000-0050	25	- 17	- 3,2

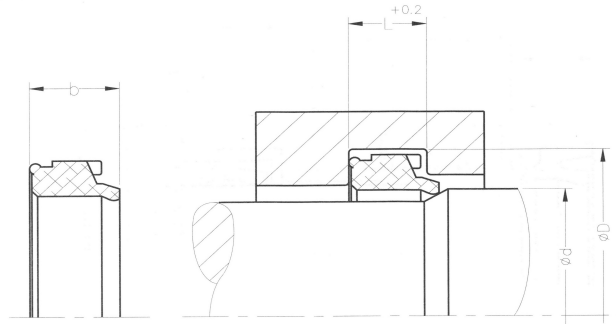

### DTH-R0-106000-NB

### Pneumatik Dämpfungsring / Pneumatic Cushioning Seal

Nummer:	d	D	b	Nummer:	d	D	b
RO-106000-NB0016	8	- 11,6	- 2,8/3,5	RO-106000-NB0044	22	- 30	- 6,2/7,8
RO-106000-NB0019	9,5	- 15	- 3,7/4,6	RO-106000-NB0048	24	- 32	- 6,2/7,8
RO-106000-NB0024	12	- 18	- 4,1/5	RO-106000-NB0050	25	- 33	- 6,2/7,8
RO-106000-NB0024-1	12	20	6,2/7,8	RO-106000-NB0060	30	40	6,2/7,8
RO-106000-NB0028	14	22	6,2/7,8	RO-106000-NB0064	32	40	6,2/7,8
RO-106000-NB0032	16	24	6,2/7,8	RO-106000-NB0072	36	46	6,2/7,8
RO-106000-NB0032-1	16	22	4,7/5,5	RO-106000-NB0080	40	50	6,2/7,8
RO-106000-NB0040	20	28	6,2/7,8				

### DTH-R0-106000-PU

### Pneumatik Dämpfungsring / Pneumatic Cushioning Seal

Nummer:	d	D	b	Nummer:	d	D	b
RO-106000-PU0024	12	- 18	- 4,1/5	RO-106000-PU0056	28	- 36	- 6,2/7,8
RO-106000-PU0024-1	12	- 20	- 6,2/7,8	RO-106000-PU0060	30	- 40	- 6,2/7,8
RO-106000-PU0028	14	- 22	- 6,2/7,8	RO-106000-PU0064-1	32	- 42	- 6,2/7,8
RO-106000-PU0032	16	- 24	- 6,2/7,8	RO-106000-PU0072	36	- 46	- 6,2/7,8
RO-106000-PU0032-1	16	- 22	- 4,7/5,5	RO-106000-PU0080	40	- 50	- 6,2/7,8
RO-106000-PU0036	18	- 26	- 6,2/7,8	RO-106000-PU0100	50	- 67	- 11/11
RO-106000-PU0040	20	- 28	- 6,2/7,8	RO-106000-PU0100-1	50	- 60	- 6,2/7,8
RO-106000-PU0048	24	- 32	- 6,2/7,8	RO-106000-PU0114	57	- 74	- 10/11
RO-106000-PU0050	25	- 33	- 6,2/7,8	RO-106000-PU0140	70	- 87	- 10/11
RO-106000-PU0050-1	25	- 35	- 6,2/7,8				

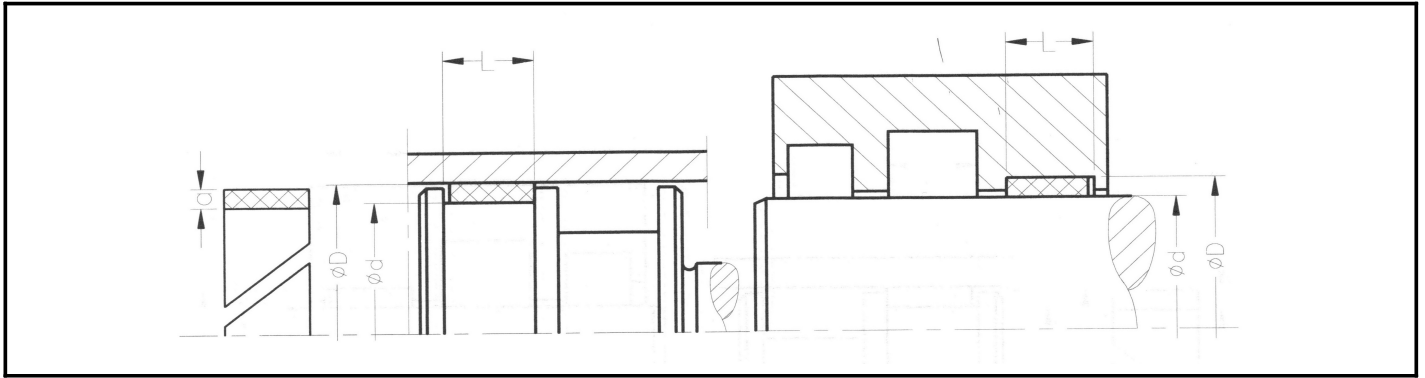

### DTH-FB-PTFE / BZ

### Führungsband / Piston Rod Guide Strip

Nummer:	d	D	Nummer:	d	D
FB-PTFE/BZ0003	1,5	- 5,6	FB-PTFE/BZ0004-4	2	- 25
FB-PTFE/BZ0005	2,5	- 15	FB-PTFE/BZ0006	3	- 15
FB-PTFE/BZ0005-1	2,5	- 20	FB-PTFE/BZ0006-1	3	- 20
FB-PTFE/BZ0005-2	2,5	- 25	FB-PTFE/BZ0006-2	3	- 25
FB-PTFE/BZ0005-3	2,5	- 30	FB-PTFE/BZ0006-3	3	- 30
FB-PTFE/BZ0005-4	2,5	- 5,6	FB-PTFE/BZ0006-4	3	- 9,7
FB-PTFE/BZ0005-5	2,5	- 9,7	FB-PTFE/BZ0008	4	- 8
FB-PTFE/BZ0004	2	- 10	FB-PTFE/BZ0008-1	4	- 9
FB-PTFE/BZ0004-1	2	- 12	FB-PTFE/BZ0008-2	4	- 9,7
FB-PTFE/BZ0004-2	2	- 15	FB-PTFE/BZ0008-3	4	- 25
FB-PTFE/BZ0004-3	2	- 20			

### DTH-FB-PTFE / Carbon

### Führungsband / Piston Rod Guide Strip

Nummer:	d	D	Nummer:	d	D
FB-PTFE/CA0005	2,5	- 15	FB-PTFE/CA0005-3	2,5	- 25
FB-PTFE/CA0005-1	2,5	- 20	FB-PTFE/CA0005-4	2,5	- 5,6
FB-PTFE/CA0005-2	2,5	- 9,7	FB-PTFE/CA0004	2	- 9,7
FB-PTFE/CA0003	1,5	- 5,6			



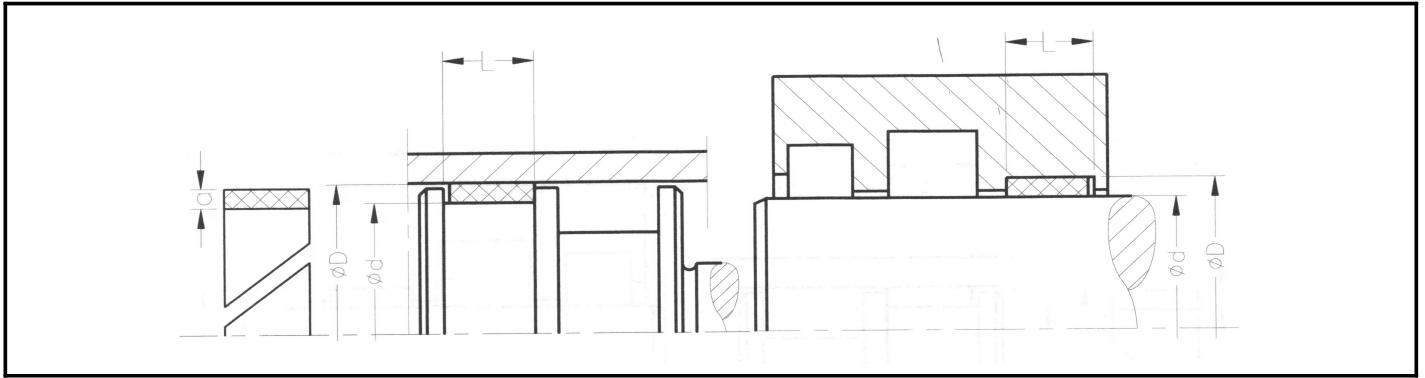

**DTH-FB-PO-PT**  
**Polyester Gewebe**

**Führungsband / Piston Rod Guide Strip**

Nummer:	d	D	Nummer:	d	D
FB-PO-PT- 0010	5,6	- 2,5	FB-PO-PT- 0040	20	- 2
FB-PO-PT- 0020	2,5	- 9,7	FB-PO-PT- 0040-1	2,5	- 20
FB-PO-PT- 0020-1	4	- 9,7	FB-PO-PT- 0040-2	3	- 20
FB-PO-PT- 0020-2	10	- 2	FB-PO-PT- 0040-3	4	- 20
FB-PO-PT- 0020-3	10	- 2,5	FB-PO-PT- 0050	25	- 2
FB-PO-PT- 0030	15	- 2	FB-PO-PT- 0050-1	2,5	- 25
FB-PO-PT- 0030-1	2,5	- 15	FB-PO-PT- 0050-2	3	- 25
FB-PO-PT- 0030-2	3	- 15	FB-PO-PT- 0050-3	4	- 25
FB-PO-PT- 0030-3	4	- 15			

**DTH-FB-PHEN**  
**Polyester Fiber Phenolic Resin**

**Führungsband / Piston Rod Guide Strip**

Nummer:	d	D	Nummer:	d	D
FB-PHEN- 0020	10	- 2	FB-PHEN- 0040-2	20	- 3
FB-PHEN- 0020-1	10	- 2,5	FB-PHEN- 0040-3	20	- 4
FB-PHEN- 0030	15	- 2	FB-PHEN- 0050	25	- 2
FB-PHEN- 0030-1	15	- 2,5	FB-PHEN- 0050-1	25	- 2,5
FB-PHEN- 0030-2	15	- 3	FB-PHEN- 0050-2	25	- 3
FB-PHEN- 0030-4	15	- 4	FB-PHEN- 0050-3	25	- 4
FB-PHEN- 0040	20	- 2	FB-PHEN- 0010	5,6	- 2,5
FB-PHEN- 0040-1	20	- 2,5	FB-PHEN- 0020-2	9,7	- 2,5

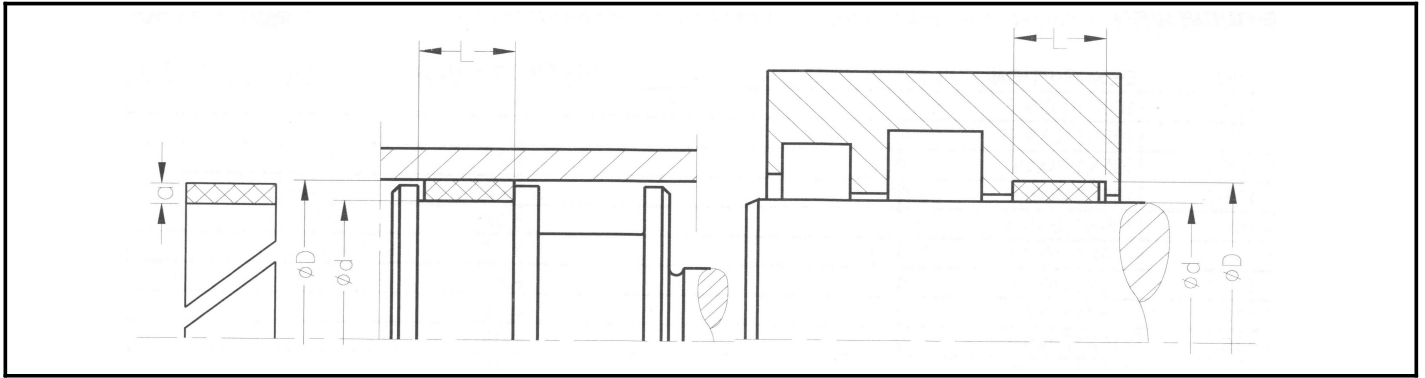

## DTH-ROPI-146000-POLY-PTFE

## Kolben Stangen Führungsring / Piston Rod Guide Ring

Nummer:	d	D	b	Nummer:	d	D	b
ROPI-146000- 0042	21	- 25	- 9,5	ROPI-146000- 0190	95	- 100	- 9,7
ROPI-146000- 0060	30	- 35	- 9,7	ROPI-146000- 0190-1	95	- 100	- 15
ROPI-146000- 0070	35	- 40	- 15	ROPI-146000- 0190-2	95	- 100	- 5,6
ROPI-146000- 0070-1	35	- 40	- 9,7	ROPI-146000- 0200	100	- 105	- 15
ROPI-146000- 0080-1	40	- 45	- 9,7	ROPI-146000- 0200-1	100	- 105	- 9,7
ROPI-146000- 0080-2	40	- 45	- 15	ROPI-146000- 0210	105	- 110	- 9,7
ROPI-146000- 0080-3	40	- 43	- 5,6	ROPI-146000- 0210-1	105	- 110	- 15
ROPI-146000- 0090	45	- 50	- 9,7	ROPI-146000- 0210-2	105	- 110	- 5,6
ROPI-146000- 0090-1	45	- 50	- 15	ROPI-146000- 0218	109	- 115	- 6,5
ROPI-146000- 0100	50	- 55	- 9,7	ROPI-146000- 0220	110	- 115	- 9,7
ROPI-146000- 0100-1	50	- 55	- 15	ROPI-146000- 0220-1	110	- 115	- 15
ROPI-146000- 0100-2	50	- 54	- 10	ROPI-146000- 0226	113	- 118	- 15
ROPI-146000- 0100-3	50	- 55	- 5,6	ROPI-146000- 0230	115	- 120	- 9,7
ROPI-146000- 0110	55	- 60	- 15	ROPI-146000- 0230-1	115	- 120	- 15
ROPI-146000- 0110-1	55	- 60	- 9,7	ROPI-146000- 0240	120	- 125	- 9,7
ROPI-146000- 0116	58	- 63	- 9,7	ROPI-146000- 0240-1	120	- 125	- 15
ROPI-146000- 0116-1	58	- 63	- 5,6	ROPI-146000- 0244	122	- 130	- 15
ROPI-146000- 0120	60	- 65	- 15	ROPI-146000- 0250	125	- 130	- 9,7
ROPI-146000- 0120-1	60	- 65	- 9,7	ROPI-146000- 0250-1	125	- 130	- 15
ROPI-146000- 0120-2	60	- 65	- 20	ROPI-146000- 0250-2	125	- 133	- 9,7
ROPI-146000- 0130	65	- 70	- 15	ROPI-146000- 0260	130	- 135	- 9,7
ROPI-146000- 0130-1	65	- 70	- 9,7	ROPI-146000- 0260-1	130	- 135	- 15
ROPI-146000- 0130-2	65	- 70	- 5,6	ROPI-146000- 0260-2	130	- 135	- 25
ROPI-146000- 0140	70	- 75	- 9,7	ROPI-146000- 0270	135	- 140	- 9,7
ROPI-146000- 0140-1	70	- 75	- 15	ROPI-146000- 0270-1	135	- 140	- 15
ROPI-146000- 0148	74	- 80	- 6,5	ROPI-146000- 0280	140	- 145	- 9,7
ROPI-146000- 0150	75	- 80	- 9,7	ROPI-146000- 0280-1	140	- 145	- 15
ROPI-146000- 0150-1	75	- 80	- 15	ROPI-146000- 0280-2	140	- 148	- 15
ROPI-146000- 0150-2	75	- 80	- 5,6	ROPI-146000- 0284	142	- 147	- 15
ROPI-146000- 0160	80	- 85	- 9,7	ROPI-146000- 0290	145	- 150	- 9,7
ROPI-146000- 0160-1	80	- 85	- 15	ROPI-146000- 0290-1	145	- 150	- 15
ROPI-146000- 0168	84	- 90	- 6,5	ROPI-146000- 0300	150	- 155	- 15
ROPI-146000- 0170	85	- 90	- 9,7	ROPI-146000- 0300-1	150	- 155	- 9,7
ROPI-146000- 0170-1	85	- 90	- 15	ROPI-146000- 0310	155	- 160	- 9,7
ROPI-146000- 0170-2	85	- 90	- 5,6	ROPI-146000- 0310-1	155	- 160	- 15
ROPI-146000- 0180	90	- 95	- 15	ROPI-146000- 0320-1	160	- 165	- 15
ROPI-146000- 0180-1	90	- 95	- 9,7	ROPI-146000- 0328	164	- 170	- 9,5
ROPI-146000- 0188	94	- 100	- 6,5	ROPI-146000- 0330	165	- 170	- 9,7

**DTH-ROPI-146000-POLY-PTFE****Kolben Stangen Führungsring / Piston Rod Guide Ring**

Nummer:	d	D	b	Nummer:	d	D	b
ROPI-146000- 0350	175	- 180	- 9,7	ROPI-146000- 0470	235	- 240	- 9,7
ROPI-146000- 0350-1	175	- 180	- 15	ROPI-146000- 0480	240	- 245	- 15
ROPI-146000- 0360	180	- 185	- 15	ROPI-146000- 0490	245	- 250	- 9,7
ROPI-146000- 0370	185	- 190	- 9,7	ROPI-146000- 0490-1	245	- 250	- 15
ROPI-146000- 0370-1	185	- 190	- 15	ROPI-146000- 0510	255	- 260	- 15
ROPI-146000- 0384-1	192	- 197	- 15	ROPI-146000- 0530	265	- 270	- 15
ROPI-146000- 0384	192	- 200	- 15	ROPI-146000- 0550	275	- 280	- 9,7
ROPI-146000- 0390	195	- 200	- 9,7	ROPI-146000- 0560	280	- 285	- 15
ROPI-146000- 0390-1	195	- 200	- 15	ROPI-146000- 0570	285	- 290	- 25
ROPI-146000- 0400	200	- 205	- 15	ROPI-146000- 0590	295	- 300	- 15
ROPI-146000- 0400-1	200	- 208	- 15	ROPI-146000- 0630	315	- 320	- 15
ROPI-146000- 0410	205	- 210	- 15	ROPI-146000- 0690	345	- 350	- 25
ROPI-146000- 0430	215	- 220	- 15	ROPI-146000- 0720	360	- 365	- 25
ROPI-146000- 0450	225	- 230	- 15				

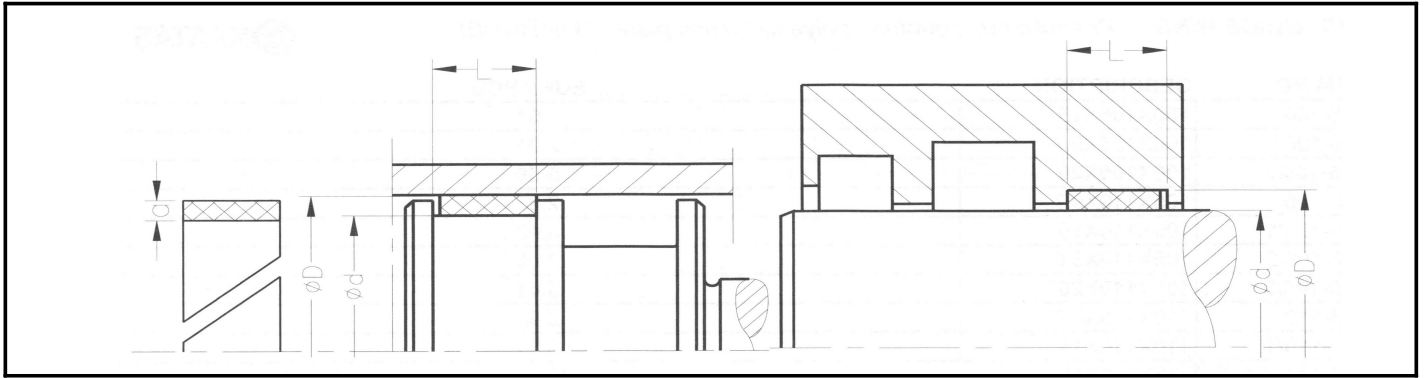

## DTH-ROPI-150000-PHE

Sythetic Fiber Phenolic Resin with PTFE

## Kolben-Stangen-Führungsring / Piston-Rod Guide Ring

Nummer:	d	D	b	Nummer:	d	D	b
ROPI-150000- 0042	21	- 25	- 9,5	ROPI-150000- 0180-2	90	- 95	- 5,6
ROPI-150000- 0044	22	- 26	- 9,5	ROPI-150000- 0188	94	- 100	- 6,5
ROPI-150000- 0056	28	- 32	- 10	ROPI-150000- 0190	95	- 100	- 9,7
ROPI-150000- 0060	30	- 35	- 9,7	ROPI-150000- 0190-1	95	- 100	- 15
ROPI-150000- 0070	35	- 40	- 15	ROPI-150000- 0200	100	- 105	- 15
ROPI-150000- 0072	36	- 40	- 10	ROPI-150000- 0200-1	100	- 105	- 9,7
ROPI-150000- 0080-1	40	- 45	- 9,7	ROPI-150000- 0200-2	100	- 105	- 20
ROPI-150000- 0080-2	40	- 45	- 15	ROPI-150000- 0210	105	- 110	- 9,7
ROPI-150000- 0090	45	- 50	- 9,7	ROPI-150000- 0210-1	105	- 110	- 15
ROPI-150000- 0090-1	45	- 50	- 15	ROPI-150000- 0210-2	105	- 110	- 5,6
ROPI-150000- 0100	50	- 55	- 9,7	ROPI-150000- 0210-3	105	- 110	- 20
ROPI-150000- 0100-1	50	- 55	- 15	ROPI-150000- 0220	110	- 115	- 9,7
ROPI-150000- 0100-2	50	- 54	- 10	ROPI-150000- 0220-1	110	- 115	- 15
ROPI-150000- 0110	55	- 60	- 15	ROPI-150000- 0226	113	- 118	- 15
ROPI-150000- 0110-1	55	- 60	- 9,7	ROPI-150000- 0230	115	- 120	- 9,7
ROPI-150000- 0112	56	- 62	- 8	ROPI-150000- 0230-1	115	- 120	- 15
ROPI-150000- 0112-1	56	- 62	- 12,5	ROPI-150000- 0240	120	- 125	- 9,7
ROPI-150000- 0116	58	- 63	- 9,7	ROPI-150000- 0240-1	120	- 125	- 15
ROPI-150000- 0120	60	- 65	- 15	ROPI-150000- 0240-2	120	- 125	- 20
ROPI-150000- 0120-1	60	- 65	- 9,7	ROPI-150000- 0250	125	- 130	- 9,7
ROPI-150000- 0120-2	60	- 65	- 20	ROPI-150000- 0250-1	125	- 130	- 15
ROPI-150000- 0126	63	- 68	- 15	ROPI-150000- 0260	130	- 135	- 9,7
ROPI-150000- 0127	63,5	- 66,54	- 6,2	ROPI-150000- 0260-1	130	- 135	- 15
ROPI-150000- 0130	65	- 70	- 15	ROPI-150000- 0270	135	- 140	- 9,7
ROPI-150000- 0130-1	65	- 70	- 9,7	ROPI-150000- 0270-1	135	- 140	- 15
ROPI-150000- 0140	70	- 75	- 9,7	ROPI-150000- 0280	140	- 145	- 9,7
ROPI-150000- 0140-1	70	- 75	- 15	ROPI-150000- 0280-1	140	- 145	- 15
ROPI-150000- 0148	74	- 80	- 6,5	ROPI-150000- 0284	142	- 147	- 15
ROPI-150000- 0150	75	- 80	- 9,7	ROPI-150000- 0290	145	- 150	- 9,7
ROPI-150000- 0150-1	75	- 80	- 15	ROPI-150000- 0290-1	145	- 150	- 15
ROPI-150000- 0160	80	- 85	- 9,7	ROPI-150000- 0300	150	- 155	- 15
ROPI-150000- 0160-1	80	- 85	- 15	ROPI-150000- 0300-1	150	- 155	- 9,7
ROPI-150000- 0160-2	80	- 85	- 20	ROPI-150000- 0310	155	- 160	- 9,7
ROPI-150000- 0168	84	- 90	- 6,5	ROPI-150000- 0310-1	155	- 160	- 15
ROPI-150000- 0170	85	- 90	- 9,7	ROPI-150000- 0310-2	155	- 163	- 25
ROPI-150000- 0170-1	85	- 90	- 15	ROPI-150000- 0330	165	- 170	- 9,7
ROPI-150000- 0180	90	- 95	- 15	ROPI-150000- 0350	175	- 180	- 9,7
ROPI-150000- 0180-1	90	- 95	- 9,7	ROPI-150000- 0350-1	175	- 180	- 15

**DTH-ROPI-150000-PHE**  
**Syntetic Fiber Phenolic Resin with PTFE**

**Kolben-Stangen-Führungsring / Piston-Rod Guide Ring**

Nummer:	d	D	b	Nummer:	d	D	b
ROPI-150000- 0360	180	- 185	- 15	ROPI-150000- 0480	240	- 245	- 15
ROPI-150000- 0370	185	- 190	- 9,7	ROPI-150000- 0490	245	- 250	- 9,7
ROPI-150000- 0370-1	185	- 190	- 15	ROPI-150000- 0490-1	245	- 250	- 15
ROPI-150000- 0384-1	192	- 197	- 15	ROPI-150000- 0530	265	- 270	- 15
ROPI-150000- 0390	195	- 200	- 9,7	ROPI-150000- 0550	275	- 280	- 9,7
ROPI-150000- 0390-1	195	- 200	- 15	ROPI-150000- 0570	285	- 290	- 25
ROPI-150000- 0400	200	- 205	- 15	ROPI-150000- 0590	295	- 300	- 15
ROPI-150000- 0424	212	- 220	- 25	ROPI-150000- 0690	345	- 350	- 25
ROPI-150000- 0430	215	- 220	- 15	ROPI-150000- 0720	360	- 365	- 25
ROPI-150000- 0450	225	- 230	- 15				

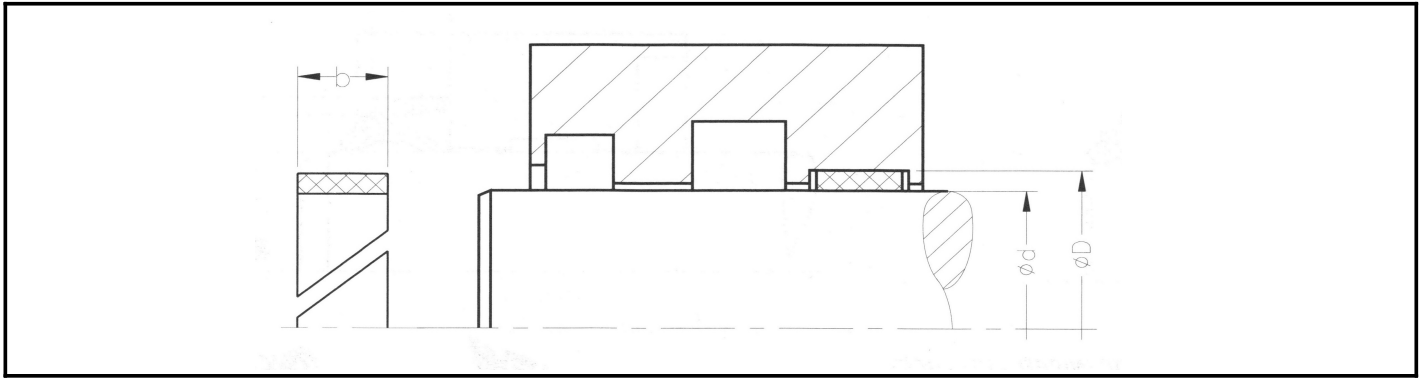

**DTH-RO-136000-POM-GLASS**

**Stangenführungsring / Rod Guide Ring**

Nummer:	d	D	b	Nummer:	d	D	b
RO-136000- 0030	15	- 20	- 5,5	RO-136000- 0070-2	35	- 40	- 9,7
RO-136000- 0032	16	- 20	- 9,4	RO-136000- 0070-3	35	- 41	- 9,4
RO-136000- 0032-1	16	- 19	- 5,8	RO-136000- 0070-4	35	- 40	- 5,4
RO-136000- 0036	18	- 22	- 9,4	RO-136000- 0070-5	35	- 40	- 6,1
RO-136000- 0036-1	18	- 22	- 14,8	RO-136000- 0070-6	35	- 40	- 9,5
RO-136000- 0040	20	- 24	- 9,4	RO-136000- 0070-7	35	- 41	- 19,8
RO-136000- 0040-1	20	- 26	- 3,8	RO-136000- 0070-8	35	- 39	- 6,3
RO-136000- 0040-2	20	- 26	- 9,5	RO-136000- 0072	36	- 40	- 9,5
RO-136000- 0044	22	- 26	- 9,4	RO-136000- 0072-1	36	- 42	- 9,6
RO-136000- 0044-1	22	- 25	- 4	RO-136000- 0072-2	36	- 41	- 9,5
RO-136000- 0044-2	22	- 27	- 9,5	RO-136000- 0072-3	36	- 41	- 5,4
RO-136000- 0050	25	- 31	- 9,4	RO-136000- 0076	38	- 42	- 9,4
RO-136000- 0050-1	25	- 29	- 9,4	RO-136000- 0076-1	38	- 41	- 20,8
RO-136000- 0050-2	25	- 30	- 5,4	RO-136000- 0076-2	38	- 42	- 4
RO-136000- 0050-3	25	- 31	- 9,7	RO-136000- 0078	39	- 44	- 15,2
RO-136000- 0052	26	- 32	- 9,8	RO-136000- 0078-1	39	- 45	- 9,8
RO-136000- 0054	27	- 32	- 5,4	RO-136000- 0080	40	- 45	- 15
RO-136000- 0054-1	27	- 31	- 9,4	RO-136000- 0080-1	40	- 44	- 9,5
RO-136000- 0056	28	- 32	- 9,5	RO-136000- 0080-2	40	- 46	- 9,6
RO-136000- 0056-2	28	- 33	- 6,2	RO-136000- 0080-3	40	- 45	- 9,5
RO-136000- 0056-3	28	- 33	- 5,5	RO-136000- 0080-4	40	- 45	- 20
RO-136000- 0056-4	28	- 34	- 9,5	RO-136000- 0080-5	40	- 45	- 4,8
RO-136000- 0056-5	28	- 33	- 9,5	RO-136000- 0080-6	40	- 45	- 5,4
RO-136000- 0060	30	- 35	- 15	RO-136000- 0080-7	40	- 46	- 12,8
RO-136000- 0060-1	30	- 34	- 9,5	RO-136000- 0080-8	40	- 44	- 6,3
RO-136000- 0060-2	30	- 36	- 9,3	RO-136000- 0080-9	40	- 45	- 9,6
RO-136000- 0060-3	30	- 35	- 9,5	RO-136000- 0080-10	40	- 46	- 9,5
RO-136000- 0060-4	30	- 35	- 8	RO-136000- 0082	41	- 46	- 5,4
RO-136000- 0060-5	30	- 35	- 5,4	RO-136000- 0090	45	- 50	- 15
RO-136000- 0062	31	- 36	- 11,2	RO-136000- 0090-1	45	- 51	- 9,5
RO-136000- 0064	32	- 36	- 9,5	RO-136000- 0090-2	45	- 50	- 9,5
RO-136000- 0064-1	32	- 38	- 9,4	RO-136000- 0090-3	45	- 51	- 12,5
RO-136000- 0064-2	32	- 37	- 11	RO-136000- 0090-4	45	- 49	- 19,8
RO-136000- 0064-3	32	- 37	- 5,4	RO-136000- 0090-5	45	- 50	- 5,4
RO-136000- 0064-4	32	- 35,1	- 3,8	RO-136000- 0092	46	- 50	- 15
RO-136000- 0066	33	- 36	- 3,8	RO-136000- 0094	47	- 53	- 12,8
RO-136000- 0070	35	- 40	- 15	RO-136000- 0096	48	- 54	- 9,5
RO-136000- 0070-1	35	- 39	- 9,5	RO-136000- 0098	49	- 55	- 9,5

**DTH-RO-136000-POM-GLASS****Stangenführungsring / Rod Guide Ring**

Nummer:	d	D	b	Nummer:	d	D	b
RO-136000- 0100	50	- 55	- 15	RO-136000- 0140-4	70	- 76	- 10
RO-136000- 0100-1	50	- 56	- 9,5	RO-136000- 0140-5	70	- 75	- 9,5
RO-136000- 0100-2	50	- 56	- 12,5	RO-136000- 0140-7	70	- 75	- 30
RO-136000- 0100-3	50	- 55	- 8	RO-136000- 0144	72	- 80	- 6
RO-136000- 0100-4	50	- 55	- 20	RO-136000- 0144-1	72	- 78	- 12,3
RO-136000- 0100-5	50	- 55	- 9,5	RO-136000- 0148	74	- 80	- 12
RO-136000- 0100-6	50	- 55	- 5,4	RO-136000- 0150	75	- 80	- 15
RO-136000- 0102	51	- 55	- 9,8	RO-136000- 0150-1	75	- 81	- 12,5
RO-136000- 0110	55	- 60	- 15	RO-136000- 0150-2	75	- 80	- 8
RO-136000- 0110-1	55	- 61	- 9,5	RO-136000- 0150-3	75	- 80	- 9,5
RO-136000- 0110-2	55	- 60	- 8	RO-136000- 0150-4	75	- 80	- 5,4
RO-136000- 0110-3	55	- 60	- 20	RO-136000- 0150-6	75	- 83	- 9,5
RO-136000- 0110-4	55	- 61	- 12,5	RO-136000- 0152	76	- 80	- 15
RO-136000- 0110-5	55	- 60	- 9,5	RO-136000- 0160	80	- 85	- 15
RO-136000- 0110-6	55	- 60	- 5,4	RO-136000- 0160-1	80	- 86	- 12,5
RO-136000- 0110-7	55	- 60	- 5,6	RO-136000- 0160-2	80	- 84	- 9,3
RO-136000- 0110-8	55	- 60	- 9,7	RO-136000- 0160-3	80	- 85	- 9,5
RO-136000- 0112	56	- 62	- 12,5	RO-136000- 0160-4	80	- 86	- 24,8
RO-136000- 0112-1	56	- 60	- 9,6	RO-136000- 0160-5	80	- 85	- 19,8
RO-136000- 0112-2	56	- 61	- 9,5	RO-136000- 0160-6	80	- 84	- 8,1
RO-136000- 0112-3	56	- 56	- 7,9	RO-136000- 0160-7	80	- 86	- 30
RO-136000- 0112-4	56	- 62	- 20	RO-136000- 0170	85	- 90	- 15
RO-136000- 0116	58	- 63	- 9,5	RO-136000- 0170-1	85	- 91	- 12,5
RO-136000- 0116-1	58	- 63	- 5,4	RO-136000- 0170-2	85	- 90	- 5,5
RO-136000- 0120	60	- 65	- 15	RO-136000- 0170-3	85	- 90	- 9,7
RO-136000- 0120-1	60	- 66	- 12,5	RO-136000- 0172	86	- 92	- 12,5
RO-136000- 0120-2	60	- 65	- 9,5	RO-136000- 0180	90	- 95	- 15
RO-136000- 0120-3	60	- 65	- 20	RO-136000- 0180-1	90	- 96	- 12,5
RO-136000- 0120-4	60	- 65	- 8	RO-136000- 0180-2	90	- 95	- 9,5
RO-136000- 0120-5	60	- 66	- 9,7	RO-136000- 0180-3	90	- 95	- 5,6
RO-136000- 0120-6	60	- 65	- 5,3	RO-136000- 0180-4	90	- 94	- 15
RO-136000- 0120-7	60	- 64	- 19,3	RO-136000- 0180-7	90	- 96	- 30
RO-136000- 0120-8	60	- 64	- 10	RO-136000- 0188	94	- 100	- 12,8
RO-136000- 0120-9	60	- 66	- 9,5	RO-136000- 0190	95	- 100	- 15
RO-136000- 0124	62	- 65	- 19,8	RO-136000- 0190-1	95	- 101	- 12,5
RO-136000- 0126	63	- 69	- 12,5	RO-136000- 0190-2	95	- 100	- 9,5
RO-136000- 0126-1	63	- 68	- 9,5	RO-136000- 0190-3	95	- 100	- 5,4
RO-136000- 0126-2	63	- 67	- 6,3	RO-136000- 0190-4	95	- 103	- 9,5
RO-136000- 0126-4	63	- 69	- 30	RO-136000- 0200	100	- 105	- 15
RO-136000- 0126-5	63	- 68	- 30	RO-136000- 0200-1	100	- 106	- 12,5
RO-136000- 0130	65	- 70	- 15	RO-136000- 0200-2	100	- 104	- 15
RO-136000- 0130-1	65	- 71	- 12,5	RO-136000- 0200-3	100	- 105	- 9,7
RO-136000- 0130-2	65	- 70	- 5,4	RO-136000- 0200-4	100	- 104	- 14,8
RO-136000- 0130-3	65	- 70	- 6,8	RO-136000- 0202	101	- 105	- 15
RO-136000- 0132	66	- 70	- 9,8	RO-136000- 0208	104	- 110	- 10
RO-136000- 0134	67	- 72	- 5,4	RO-136000- 0210	105	- 110	- 15
RO-136000- 0140	70	- 75	- 15	RO-136000- 0210-1	105	- 110	- 8
RO-136000- 0140-1	70	- 76	- 12,5	RO-136000- 0210-2	105	- 110	- 9,5
RO-136000- 0140-2	70	- 75	- 5,4	RO-136000- 0210-3	105	- 115	- 16,8
RO-136000- 0140-3	70	- 76	- 25	RO-136000- 0210-4	105	- 115	- 17

**DTH-RO-136000-POM-GLASS**
**Stangenführungsring / Rod Guide Ring**

Nummer:	d	D	b	Nummer:	d	D	b
RO-136000- 0220	110	- 116	- 12,5	RO-136000- 0280-1	140	- 146	- 12,5
RO-136000- 0220-1	110	- 115	- 9,5	RO-136000- 0292	146	- 150	- 10
RO-136000- 0220-2	110	- 115	- 20	RO-136000- 0300	150	- 155	- 15
RO-136000- 0220-3	110	- 116	- 7,5	RO-136000- 0300-1	150	- 156	- 12,5
RO-136000- 0228	114	- 119	- 14,8	RO-136000- 0300-2	150	- 154	- 15
RO-136000- 0230	115	- 120	- 15	RO-136000- 0300-4	150	- 160	- 34,8
RO-136000- 0230-1	115	- 121	- 12,5	RO-136000- 0300-5	150	- 155	- 24,8
RO-136000- 0230-2	115	- 120	- 9,5	RO-136000- 0300-6	150	- 156	- 19
RO-136000- 0238	119	- 125	- 15	RO-136000- 0304	152	- 160	- 15
RO-136000- 0240	120	- 125	- 15	RO-136000- 0340	170	- 175	- 15
RO-136000- 0240-1	120	- 126	- 12,5	RO-136000- 0350	175	- 180	- 9,5
RO-136000- 0240-2	120	- 125	- 9,5	RO-136000- 0360	180	- 185	- 15
RO-136000- 0250	125	- 131	- 12,5	RO-136000- 0360-1	180	- 186	- 19
RO-136000- 0250-1	125	- 130	- 15	RO-136000- 0380	190	- 195	- 15
RO-136000- 0250-2	125	- 130	- 7	RO-136000- 0390	195	- 200	- 15
RO-136000- 0260	130	- 135	- 15	RO-136000- 0400	200	- 206	- 19
RO-136000- 0260-1	130	- 136	- 12,5	RO-136000- 0400-1	200	- 205	- 15
RO-136000- 0266	133	- 140	- 15	RO-136000- 0420	210	- 216	- 19
RO-136000- 0270	135	- 140	- 9,5	RO-136000- 0440	220	- 226	- 19
RO-136000- 0270-1	135	- 140	- 15	RO-136000- 0600	300	- 306	- 19
RO-136000- 0280	140	- 145	- 15				

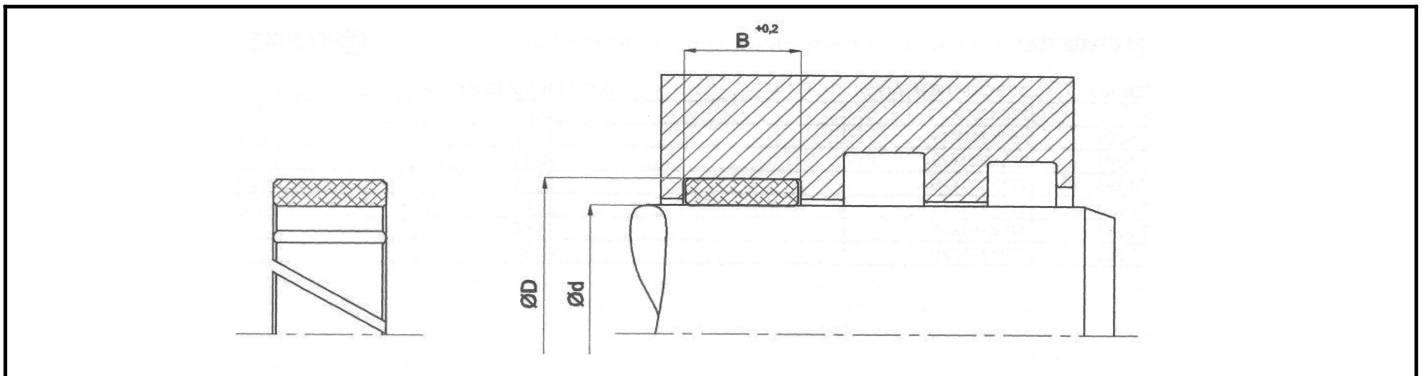
**DTH-RO-148000-POM-GLASS**
**Stangenführungsring / Rod Guide Ring**

Nummer:	d	D	b	Nummer:	d	D	b
RO-148000- 0040	20	- 30	- 13	RO-148000- 0090	45	- 55	- 16
RO-148000- 0050	25	- 35	- 13	RO-148000- 0090-1	45	- 60	- 16
RO-148000- 0060	30	- 40	- 13	RO-148000- 00110	55	- 65	- 16
RO-148000- 0070	35	- 45	- 13	RO-148000- 00130	65	- 75	- 16
RO-148000- 0080	40	- 50	- 16	RO-148000- 00150	75	- 85	- 16



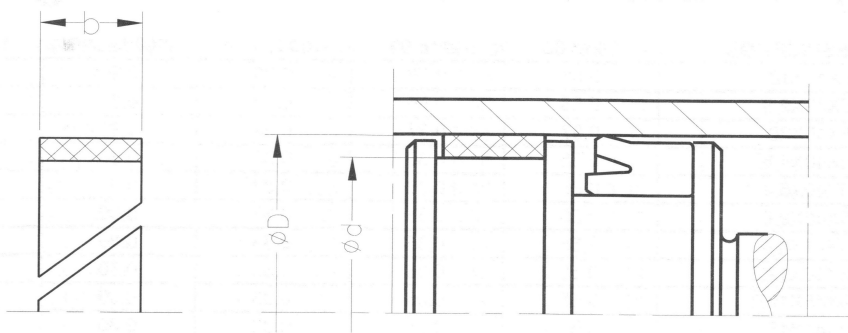

### DTH-PI-138000-POM-GLASS

### Kolbenführungsring / Piston Guide Ring

Nummer:	d	D	b	Nummer:	d	D	b
PI-138000- 0040	20	- 16	- 9,4	PI-138000- 0090-2	45	- 40	- 9,5
PI-138000- 0044	22	- 18	- 9,4	PI-138000- 0090-3	45	- 41	- 10
PI-138000- 0050	25	- 21	- 9,5	PI-138000- 0090-4	45	- 39	- 9,8
PI-138000- 0050-1	25	- 21	- 8	PI-138000- 0090-5	45	- 40	- 20
PI-138000- 0050-2	25	- 22	- 4	PI-138000- 0090-6	45	- 40	- 4,8
PI-138000- 0050-3	25	- 21,9	- 3,8	PI-138000- 0090-7	45	- 40	- 5,4
PI-138000- 0060	30	- 26	- 9,5	PI-138000- 0090-8	45	- 40	- 9,6
PI-138000- 0060-1	30	- 25	- 5,4	PI-138000- 0092	46	- 41	- 5,4
PI-138000- 0064	32	- 28	- 9,5	PI-138000- 0092-1	46	- 40	- 12,8
PI-138000- 0064-1	32	- 26	- 9,7	PI-138000- 0098	49	- 45	- 19,8
PI-138000- 0064-2	32	- 28,9	- 3,8	PI-138000- 0100	50	- 45	- 15
PI-138000- 0064-3	32	- 27	- 5,4	PI-138000- 0100-1	50	- 44	- 9,5
PI-138000- 0066	33	- 28	- 5,5	PI-138000- 0100-2	50	- 45	- 9,5
PI-138000- 0066-1	33	- 28	- 9,5	PI-138000- 0100-3	50	- 45	- 5,4
PI-138000- 0068	34	- 28	- 9,5	PI-138000- 0100-4	50	- 46	- 15
PI-138000- 0070	35	- 30	- 15	PI-138000- 0100-5	50	- 43,5	- 5,6
PI-138000- 0070-1	35	- 31	- 9,5	PI-138000- 0106	53	- 47	- 12,8
PI-138000- 0070-2	35	- 29	- 9,5	PI-138000- 0110	55	- 50	- 15
PI-138000- 0070-3	35	- 29	- 9,8	PI-138000- 0110-1	55	- 49	- 12,5
PI-138000- 0070-4	35,1	- 32	- 3,8	PI-138000- 0110-2	55	- 50	- 8
PI-138000- 0070-5	35	- 30	- 9,5	PI-138000- 0110-3	55	- 50	- 20
PI-138000- 0070-6	35	- 30	- 5,4	PI-138000- 0110-4	55	- 50	- 9,5
PI-138000- 0070-7	35	- 30	- 8	PI-138000- 0110-5	55	- 49	- 9,3
PI-138000- 0072	36	- 33	- 3,8	PI-138000- 0110-6	55	- 49	- 9,8
PI-138000- 0074	37	- 32	- 5,5	PI-138000- 0110-7	55	- 51	- 9,8
PI-138000- 0080	40	- 35	- 15	PI-138000- 0110-8	55	- 50	- 5,4
PI-138000- 0080-1	40	- 36	- 9,5	PI-138000- 0120	60	- 55	- 15
PI-138000- 0080-2	40	- 34	- 9,7	PI-138000- 0120-1	60	- 54	- 12,5
PI-138000- 0080-3	40	- 35	- 5,4	PI-138000- 0120-2	60	- 54	- 9,3
PI-138000- 0080-4	40	- 35	- 6,1	PI-138000- 0120-3	60	- 55	- 9,5
PI-138000- 0080-5	40	- 35	- 9,5	PI-138000- 0120-4	60	- 56	- 9,6
PI-138000- 0080-6	40	- 34	- 9,5	PI-138000- 0120-5	60	- 56	- 10
PI-138000- 0082	41	- 36	- 9,5	PI-138000- 0120-6	60	- 55	- 5,4
PI-138000- 0082-1	41	- 38	- 20,8	PI-138000- 0120-7	60	- 55	- 5,6
PI-138000- 0082-2	41	- 35	- 19,8	PI-138000- 0120-8	60	- 55	- 9,7
PI-138000- 0082-3	41	- 36	- 5,4	PI-138000- 0120-9	60	- 56	- 7,9
PI-138000- 0090	45	- 40	- 15	PI-138000- 0124	62	- 56	- 20
PI-138000- 0090-1	45	- 41	- 9,5	PI-138000- 0124-1	62	- 56	- 9,5

**DTH-PI-138000-POM-GLASS****Kolbenführungsring / Piston Guide Ring**

Nummer:	d	D	b	Nummer:	d	D	b
PI-138000- 0126	63	- 57	- 12,5	PI-138000- 0190	95	- 90	- 15
PI-138000- 0126-1	63	- 58	- 9,8	PI-138000- 0190-1	95	- 89	- 12,5
PI-138000- 0126-2	63	- 58	- 9,5	PI-138000- 0190-2	95	- 90	- 9,5
PI-138000- 0126-3	63	- 59	- 9,5	PI-138000- 0192-2	96	- 90	- 30
PI-138000- 0126-4	63	- 57	- 9,8	PI-138000- 0200	100	- 95	- 15
PI-138000- 0126-5	63	- 58	- 5,4	PI-138000- 0200-1	100	- 94	- 12,5
PI-138000- 0128	64	- 60	- 19,3	PI-138000- 0200-2	100	- 95	- 5,4
PI-138000- 0128-1	64	- 60	- 10	PI-138000- 0200-3	100	- 96	- 10
PI-138000- 0130	65	- 60	- 15	PI-138000- 0200-4	100	- 94	- 12,8
PI-138000- 0130-1	65	- 59	- 12,5	PI-138000- 0200-5	100	- 95	- 9,5
PI-138000- 0130-2	65	- 60	- 9,5	PI-138000- 0200-6	100	- 95	- 10
PI-138000- 0130-3	65	- 62	- 19,8	PI-138000- 0200-7	100	- 95	- 14,8
PI-138000- 0130-4	65	- 60	- 5,3	PI-138000- 0206	103	- 95	- 9,5
PI-138000- 0130-5	65	- 60	- 8	PI-138000- 0208	104	- 100	- 15
PI-138000- 0132	66	- 60	- 9,5	PI-138000- 0210	105	- 100	- 15
PI-138000- 0136	68	- 63	- 9,5	PI-138000- 0210-1	105	- 101	- 15
PI-138000- 0138	69	- 63	- 30	PI-138000- 0210-2	105	- 100	- 9,7
PI-138000- 0140	70	- 65	- 15	PI-138000- 0220	110	- 104	- 12,5
PI-138000- 0140-1	70	- 64	- 12,5	PI-138000- 0220-1	110	- 105	- 9,5
PI-138000- 0140-2	70	- 65	- 9,5	PI-138000- 0220-2	110	- 106	- 14,7
PI-138000- 0140-3	70	- 66	- 9,8	PI-138000- 0220-3	110	- 104	- 10
PI-138000- 0140-4	70	- 65	- 5,4	PI-138000- 0220-6	110	- 105	- 14,8
PI-138000- 0140-7	70	- 64	- 10	PI-138000- 0230	115	- 109	- 12,5
PI-138000- 0140-8	70	- 65	- 7	PI-138000- 0230-1	115	- 110	- 9,5
PI-138000- 0144	72	- 67	- 5,4	PI-138000- 0230-2	115	- 105	- 16,8
PI-138000- 0150	75	- 70	- 15	PI-138000- 0240	120	- 114	- 12,5
PI-138000- 0150-1	75	- 69	- 12,5	PI-138000- 0240-1	120	- 115	- 15
PI-138000- 0150-2	75	- 70	- 9,5	PI-138000- 0240-2	120	- 115	- 9,5
PI-138000- 0150-3	75	- 70	- 5,4	PI-138000- 0250	125	- 120	- 15
PI-138000- 0150-4	75	- 70	- 30	PI-138000- 0250-1	125	- 119	- 12,5
PI-138000- 0160	80	- 75	- 15	PI-138000- 0250-2	125	- 120	- 9,5
PI-138000- 0160-1	80	- 74	- 12,5	PI-138000- 0250-4	125	- 119	- 15
PI-138000- 0160-2	80	- 75	- 8	PI-138000- 0260	130	- 124	- 12,5
PI-138000- 0160-3	80	- 75	- 9,5	PI-138000- 0260-1	130	- 125	- 15
PI-138000- 0160-4	80	- 76	- 15	PI-138000- 0260-2	130	- 125	- 7
PI-138000- 0160-5	80	- 72	- 6	PI-138000- 0270	135	- 130	- 15
PI-138000- 0160-6	80	- 75	- 5,4	PI-138000- 0270-1	135	- 129	- 12,6
PI-138000- 0160-7	80	- 74	- 12	PI-138000- 0280	140	- 134	- 12,5
PI-138000- 0166	83	- 75	- 9,5	PI-138000- 0280-1	140	- 135	- 9,5
PI-138000- 0170	85	- 80	- 15	PI-138000- 0280-2	140	- 135	- 15
PI-138000- 0170-1	85	- 79	- 12,5	PI-138000- 0280-3	140	- 133	- 15
PI-138000- 0170-2	85	- 80	- 9,5	PI-138000- 0280-4	140	- 133	- 19,8
PI-138000- 0170-3	85	- 80	- 19,8	PI-138000- 0290	145	- 140	- 15
PI-138000- 0172	86	- 80	- 30	PI-138000- 0300	150	- 144	- 12,5
PI-138000- 0180-1	90	- 84	- 12,5	PI-138000- 0300-1	150	- 144	- 19
PI-138000- 0180	90	- 85	- 15	PI-138000- 0300-2	150	- 145	- 9,5
PI-138000- 0180-2	90	- 85	- 5,5	PI-138000- 0300-3	150	- 146	- 10
PI-138000- 0180-3	90	- 85	- 9,7	PI-138000- 0300-4	150	- 143	- 19,8
PI-138000- 0180-4	90	- 85	- 9,5	PI-138000- 0308	154	- 150	- 15
PI-138000- 0188	94	- 90	- 15	PI-138000- 0312	156	- 150	- 19

**DTH-PI-138000-POM-GLASS**
**Kolbenführungsring / Piston Guide Ring**

Nummer:	d	D	b	Nummer:	d	D	b
PI-138000- 0320	160	- 155	- 15	PI-138000- 0370	185	- 180	- 15
PI-138000- 0320-1	160	- 154	- 19	PI-138000- 0380	190	- 185	- 15
PI-138000- 0320-2	160	- 155	- 9,5	PI-138000- 0390	195	- 190	- 15
PI-138000- 0320-4	160	- 152	- 15	PI-138000- 0400	200	- 194	- 19
PI-138000- 0330	165	- 160	- 15	PI-138000- 0400-1	200	- 195	- 15
PI-138000- 0332	166	- 160	- 12,5	PI-138000- 0420	210	- 205	- 9,7
PI-138000- 0340	170	- 165	- 15	PI-138000- 0440	220	- 214	- 19
PI-138000- 0350	175	- 170	- 15	PI-138000- 0450	225	- 219	- 19
PI-138000- 0360	180	- 174	- 19	PI-138000- 0452	226	- 220	- 19
PI-138000- 0360-1	180	- 175	- 9,5	PI-138000- 0500	250	- 244	- 19

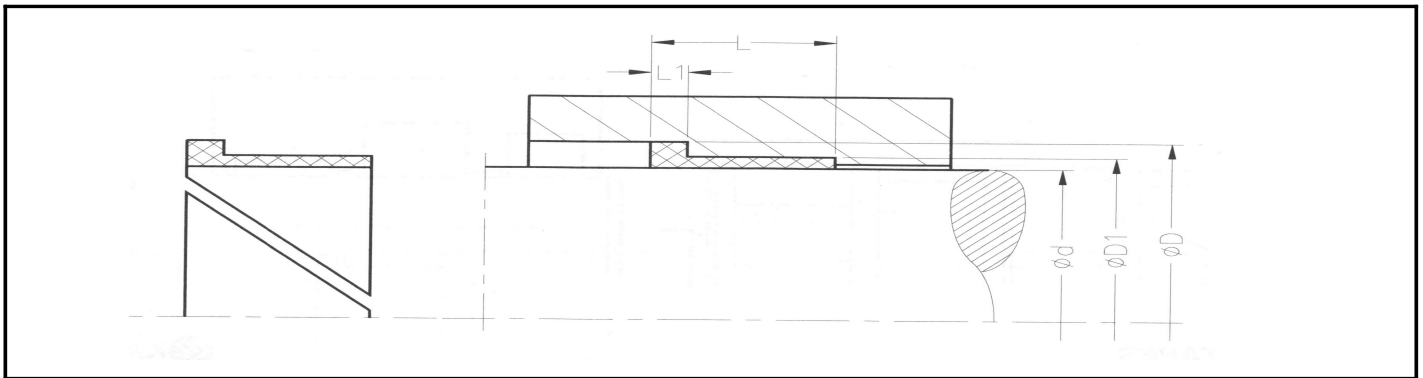
**DTH-FB-TELE**
**Teleskop Führungsring / Telescoping Guide Ring**

Nummer:	d	D	b	b
FB-TELE- 0110	55	- 60	- 65	- 30/5
FB-TELE- 0120	60	- 65	- 70	- 30/5
FB-TELE- 0150	75	- 80	- 85	- 18/5
FB-TELE- 0150-1	75	- 80	- 85	- 30/5
FB-TELE- 0180	90	- 95	- 100	- 30/5
FB-TELE- 0190	95	- 100	- 105	- 18/5
FB-TELE- 0190-1	95	- 100	- 105	- 30/5
FB-TELE- 0210	105	- 110	- 115	- 30/5
FB-TELE- 0230	115	- 120	- 125	- 18/5
FB-TELE- 0230-1	115	- 120	- 125	- 30/5
FB-TELE- 0270	135	- 140	- 145	- 18/5
FB-TELE- 0270-1	135	- 140	- 145	- 30/5
FB-TELE- 0320	160	- 165	- 170	- 18/5
FB-TELE- 0320-1	160	- 165	- 170	- 30/5
FB-TELE- 0370	185	- 190	- 195	- 18/5
FB-TELE- 0370-1	185	- 190	- 195	- 30/5
FB-TELE- 0424	212	- 217	- 222	- 18/5
FB-TELE- 0424-1	212	- 217	- 222	- 30/5

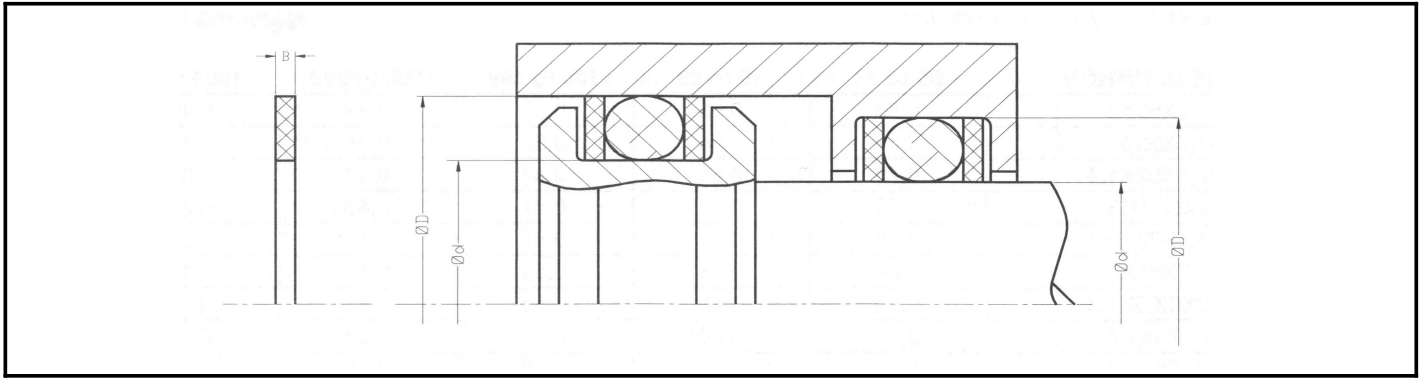

## DTH-PIRO-162000-TPE

## Stützring / Back Up Ring

Nummer:	d	D	b	Nummer:	d	D	b
PIRO-162000- 0028	14	- 18	- 1,3	PIRO-162000- 0110	55	- 63	- 1,9
PIRO-162000- 0038	19	- 23	- 1,3	PIRO-162000- 0110-1	55,7	- 60	- 1,3
PIRO-162000- 0040	20	- 25	- 1,3	PIRO-162000- 0110-2	55,15	- 61	- 1,45
PIRO-162000- 0040-1	20	- 30	- 1,3	PIRO-162000- 0110-3	55	- 59,8	- 2
PIRO-162000- 0050	25,4	- 30	- 1,9	PIRO-162000- 0110-4	55	- 65	- 1,9
PIRO-162000- 0050-1	25	- 30	- 1,3	PIRO-162000- 0112	56	- 60,5	- 1,3
PIRO-162000- 0052	26	- 30	- 2	PIRO-162000- 0114	57,6	- 63	- 2
PIRO-162000- 0054	27	- 32	- 1,3	PIRO-162000- 0114-1	57,7	- 63,7	- 1,05
PIRO-162000- 0056	28	- 34	- 1,3	PIRO-162000- 0114-2	57,4	- 63	- 1,4
PIRO-162000- 0060	30	- 35	- 1,3	PIRO-162000- 0116	58	- 63	- 1,3
PIRO-162000- 0070	35	- 40	- 1,3	PIRO-162000- 0116-1	58,5	- 63,5	- 1,3
PIRO-162000- 0070-1	35,15	- 41	- 1,45	PIRO-162000- 0116-2	58,7	- 65	- 1,9
PIRO-162000- 0072	36	- 40,5	- 1,25	PIRO-162000- 0118	59	- 63,5	- 1,3
PIRO-162000- 0072-1	36	- 40	- 1,8	PIRO-162000- 0120-1	60	- 70	- 1,7
PIRO-162000- 0076	38	- 43	- 1,3	PIRO-162000- 0120-2	60	- 65	- 1,3
PIRO-162000- 0080	40	- 45	- 1,3	PIRO-162000- 0124	62	- 70	- 1,9
PIRO-162000- 0080-1	40,4	- 45	- 1,9	PIRO-162000- 0124-1	62,2	- 68	- 1,3
PIRO-162000- 0080-2	40,7	- 45	- 1,3	PIRO-162000- 0124-2	62,15	- 71	- 1,7
PIRO-162000- 0082	41	- 45,5	- 1,25	PIRO-162000- 0126	63,6	- 70	- 1,4
PIRO-162000- 0086	43	- 48	- 1,3	PIRO-162000- 0168	64	- 73,3	- 1,5
PIRO-162000- 0086-1	43,7	- 50	- 1,9	PIRO-162000- 0130	65	- 70	- 1,3
PIRO-162000- 0090	45	- 50	- 1,3	PIRO-162000- 0130-1	65	- 75	- 1,7
PIRO-162000- 0090-1	45,15	- 51	- 1,45	PIRO-162000- 0130-2	65,6	- 75,5	- 1,25
PIRO-162000- 0090-2	45	- 51	- 1,05	PIRO-162000- 0132	66	- 70,5	- 1,3
PIRO-162000- 0090-3	45	- 49,5	- 1,5	PIRO-162000- 0132-1	66,5	- 71	- 1,9
PIRO-162000- 0092	46	- 50,5	- 1,25	PIRO-162000- 0136	68,4	- 74,8	- 1,55
PIRO-162000- 0094	47	- 52	- 1,3	PIRO-162000- 0138	69,8	- 75	- 1,3
PIRO-162000- 0094-1	47	- 51,5	- 1,5	PIRO-162000- 0138-1	69	- 75	- 1,5
PIRO-162000- 0096	48	- 54	- 1,5	PIRO-162000- 0140	70	- 75	- 1,3
PIRO-162000- 0098	49,3	- 55	- 1,3	PIRO-162000- 0140-1	70	- 80	- 1,7
PIRO-162000- 0098-1	49	- 55	- 2,5	PIRO-162000- 0144	72	- 80	- 1,9
PIRO-162000- 0100	50	- 55	- 1,3	PIRO-162000- 0144-1	72,15	- 81	- 1,7
PIRO-162000- 0100-2	50	- 60	- 1,7	PIRO-162000- 0144-2	72,5	- 80	- 3
PIRO-162000- 00104	52	- 60	- 1,9	PIRO-162000- 0150	75	- 80	- 1,3
PIRO-162000- 0106-1	53	- 63	- 1,7	PIRO-162000- 0150-3	75	- 85	- 1,9
PIRO-162000- 0106-2	53,7	- 59,5	- 1	PIRO-162000- 0150-1	76	- 80,5	- 1,25
PIRO-162000- 0106-3	53	- 59	- 1,5	PIRO-162000- 0150-2	75,6	- 82	- 1,9
PIRO-162000- 0106	53,7	- 60	- 1,9	PIRO-162000- 0154	77	- 83	- 1,5

## DTH-PIRO-162000-TPE

## Stützring / Back Up Ring

Nummer:	d	D	b	Nummer:	d	D	b
PIRO-162000- 0158	79,8	- 89,1	- 1,5	PIRO-162000- 0270	135	- 140	- 1,25
PIRO-162000- 0160	80	- 85	- 1,3	PIRO-162000- 0274	137,8	- 149,8	- 2,45
PIRO-162000- 0164	82	- 90	- 1,9	PIRO-162000- 0276	138,4	- 150	- 2,5
PIRO-162000- 0164-1	82,15	- 91	- 1,7	PIRO-162000- 0280	140	- 150	- 1,7
PIRO-162000- 0168	84,3	- 90	- 1,3	PIRO-162000- 0290	145	- 160	- 2,1
PIRO-162000- 0170	85	- 90	- 1,3	PIRO-162000- 0290-1	145	- 155	- 1,9
PIRO-162000- 0170-1	85,2	- 90	- 1,4	PIRO-162000- 0300-1	150	- 160	- 1,7
PIRO-162000- 0180	90	- 95	- 1,3	PIRO-162000- 0300	150,7	- 160	- 1,9
PIRO-162000- 0180-3	90	- 94,8	- 1,05	PIRO-162000- 0302	151	- 160	- 1,9
PIRO-162000- 0182	91	- 96,4	- 1,3	PIRO-162000- 0306	153,3	- 165	- 2
PIRO-162000- 0180-1	90	- 100	- 1,7	PIRO-162000- 0310-1	155	- 165	- 1,7
PIRO-162000- 0184	92	- 100	- 1,9	PIRO-162000- 0310-2	155	- 165	- 1,9
PIRO-162000- 0184-1	92,6	- 101	- 1,5	PIRO-162000- 0310	155	- 170	- 2,1
PIRO-162000- 0188	94	- 99,8	- 3	PIRO-162000- 0312	156,12	- 170	- 2,5
PIRO-162000- 0190	95	- 100	- 1,3	PIRO-162000- 0316	158,4	- 170	- 2,5
PIRO-162000- 0190-1	95	- 105	- 1,9	PIRO-162000- 0322	161,8	- 170	- 1,9
PIRO-162000- 0190-2	95,7	- 105	- 1,7	PIRO-162000- 0330	165	- 180	- 2,1
PIRO-162000- 0200-1	100	- 108,2	- 1,9	PIRO-162000- 0340	170,7	- 180	- 1,9
PIRO-162000- 0200-2	100,6	- 110	- 1,7	PIRO-162000- 0340-1	170	- 181	- 2
PIRO-162000- 0200-3	100,2	- 105	- 1,4	PIRO-162000- 0350	175	- 190	- 2,1
PIRO-162000- 0200	100	- 110	- 1,7	PIRO-162000- 0362	181,8	- 190	- 1,9
PIRO-162000- 0204	102	- 110	- 1,9	PIRO-162000- 0370	185	- 200	- 2,1
PIRO-162000- 0210	105	- 110	- 1,3	PIRO-162000- 0374	187,4	- 200	- 2
PIRO-162000- 0210-1	105,7	- 115	- 1,7	PIRO-162000- 0376	188,4	- 200	- 2,5
PIRO-162000- 0214	107	- 115	- 1,9	PIRO-162000- 0380	190,7	- 200	- 1,9
PIRO-162000- 0216	108	- 114	- 1,5	PIRO-162000- 0390	195	- 210	- 2,1
PIRO-162000- 0218	109	- 118,3	- 1,87	PIRO-162000- 0384	192,6	- 202	- 1,9
PIRO-162000- 0220	110	- 115	- 1,3	PIRO-162000- 0396	198,4	- 210	- 2,5
PIRO-162000- 0220-1	110	- 120	- 1,7	PIRO-162000- 0402	201,8	- 210	- 1,9
PIRO-162000- 0220-2	110	- 120	- 1,9	PIRO-162000- 0410	205,7	- 215	- 1,9
PIRO-162000- 0224	112	- 120	- 1,9	PIRO-162000- 0420	210,7	- 220	- 1,9
PIRO-162000- 0228	114,8	- 125	- 2	PIRO-162000- 0432	216	- 230	- 2,1
PIRO-162000- 0230	115	- 125	- 1,7	PIRO-162000- 0440	220,7	- 230	- 1,9
PIRO-162000- 0230-2	115	- 125	- 1,9	PIRO-162000- 0440-1	220,3	- 232	- 2
PIRO-162000- 0230-1	115	- 124,3	- 1,5	PIRO-162000- 0450	225	- 240	- 2,1
PIRO-162000- 0234	117	- 125	- 1,9	PIRO-162000- 0456	228,4	- 240	- 2,5
PIRO-162000- 0236	118,2	- 127,5	- 1,5	PIRO-162000- 0470	235	- 250	- 2,05
PIRO-162000- 0240	120	- 125	- 1,3	PIRO-162000- 0480	240,7	- 250	- 1,9
PIRO-162000- 0240-1	120	- 130	- 1,7	PIRO-162000- 0482	241,8	- 250	- 1,9
PIRO-162000- 0240-2	120,7	- 127	- 1,3	PIRO-162000- 0490	245	- 260	- 2,05
PIRO-162000- 0244	122	- 130	- 1,9	PIRO-162000- 0490-1	245,7	- 255	- 1,9
PIRO-162000- 0250	125	- 135	- 1,9	PIRO-162000- 0520	260,7	- 270	- 1,9
PIRO-162000- 0260	130	- 140	- 1,7	PIRO-162000- 0532	266	- 280	- 2,5
PIRO-162000- 0260-1	130,7	- 140	- 1,9	PIRO-162000- 0580	290,7	- 300	- 1,9
PIRO-162000- 0260-2	130	- 142	- 2	PIRO-162000- 0590	295,7	- 305	- 1,9
PIRO-162000- 0264	132,6	- 141	- 1,5	PIRO-162000- 0632	316	- 330	- 2,5

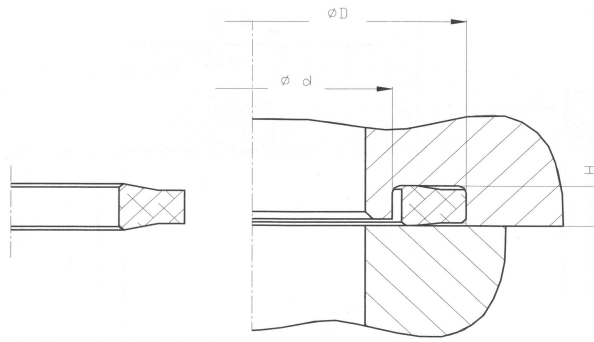

**DTH-FLA-164000-PU**

**Flanschdichtung / Flange Seal**

Nummer:	d	D	b	Nummer:	d	D	b
FLA-164000-0034	17	- 25,4	- 2,85	FLA-164000-0148	74	- 82,4	- 2,85
FLA-164000-0110	55	- 63,4	- 2,85	FLA-164000-0174	87,17	- 95,57	- 4,2
FLA-164000-0120	60,2	- 69	- 3,3	FLA-164000-0190	95	- 103,4	- 2,85
FLA-164000-0132	66,8	- 75	- 2,85				



Angaben in diesem Katalog stellen nur allgemeine, nicht verbindliche Richtwerte dar, die nicht für jeden Einsatzzweck Gültigkeit beanspruchen.

Vervielfältigungen in jeglicher Form bedürfen der ausdrücklichen Genehmigung.

Consequently the information in this publication can only portray general, non-binding guidelines.

Copies in any form requires the express approval.

© DTH-DICHTUNGSTECHNIK GMBH  
Hanau (Germany), 2011

Coverdesign: [www.joy-designs.de](http://www.joy-designs.de)  
Coverphoto: [www.brightspot-fotoservice.de](http://www.brightspot-fotoservice.de)